

ALUKON

Sonnenschutz Rollladen Insektenschutz

SYSTEMKOMPONENTEN

Components

Composants

Onderdelen

Systemowe komponenty do produkcji

Systémové komponenty

Rendszer-komponensek

Sastav sistema

How to reach us

Monday to Thursday	7:00am - 5:00pm
Friday	7:00am - 1:00pm
Postal address	ALUKON KG Münchberger Straße 31 D-95176 Konradsreuth
Internet:	www.alukon.com info@alukon.com

Switchboard

Phone	+49 9292 - 950 - 0
Fax	+49 9292 - 950 - 290

Your contact

Phone	+49 9292 - 950 - 207
Fax	+49 9292 - 950 - 5207

Important advice

ALUKON offers a wide range of products and accessories for roller shutters and garage doors. ALUKON customers benefit from prices without surcharge for extruded products in 30 selected RAL colours and DB 703 in brilliant, mat and structured coating. For an overview of this colours, please refer to the section "technical overview" at the end of this catalogue.

Please note: ALUKON standard colours are not official RAL colours.

With publication of this catalogue, previous versions are no longer valid.

All indicated measures refer to the appropriate components and should not be interpreted as total dimension of the assembled unit. Dimensional tolerances may appear due to fabrication.

We reserve the right to alter or change products due to technical improvement. The monthly update can be found under the dealer's portal of our website.

All deliveries are made by our own trucks or assigned parcel service or forwarding agency. Special transport costs at the request of the buyer are not included in the price and shall be paid by the buyer.

No liability accepted for printing errors.

Terms and conditions:

Customer ID:

Company:

Address:

Postal Code, City:

Country:

All indicated prices are net prices, German VAT not included.

Terms of payment:	days	% cash discount
	net days	

Delivery: Free delivery by arrangement

Offer without engagement.

Deliveries are subject to the current version of our "General Conditions of Delivery and Payment".

Surcharges for special requests

Surcharge (%)... for deliveries in small quantities:

For special colours:

Surcharge... for pre-cut part orders:

Please note:

Products from our top mounted shutter portfolio are only available in standard packing units. Pre-cut part orders are not accepted. We provide pre-cut service for very small quantity requirements, if purchase of standard units is not economically viable.

For higher demands other pricing terms are valid, especially for inappropriate measures with a high waste material rate. Pricing and delivery terms for such requirements upon request.

Coating costs:

As from now, small quantity and pre-cut orders in special RAL colours will be calculated by order value.

The table below shows the appropriate surcharges:

Order value (of the RAL colour)	Standard surcharge
less than 25 €	€
25 € - 50 €	€
50 € - 75 €	€
75 € - 100 €	€
more than 100 €	-

We deliver 30 RAL colours and DB703 without surcharge. The selection is listed at the end of this catalogue.

PLEASE NOTE: PRE-CUT PARTS AND CURTAINS ARE CUSTOMIZED PRODUCTS. RETURN OR EXCHANGE ARE NOT ACCEPTED.

Special agreements

description	Price level	Price
-------------	-------------	-------

LIST OF CONTENTS

COMPONENTS FOR THE FABRICATION OF BUILT-ON AND TOP-MOUNTED ROLLER SHUTTERS AND INSECT REPELLING SYSTEMS

Important information and general sales conditions

1	Roll formed boxes	7
2	Extruded boxes	15
3	Built-in boxes, end profile KAP, angles and concealed rails.....	23
4	End caps, safety plates and guide terminals	35
5	Standard and special guide channels for the mini and maxi sector, insert, guide channel end pieces, covers, tilt hinges.....	47
6	Guide channels for new buildings, inserts	67
7	Roller shutter profiles for the mini, maxi and new building sector, locking clips	73
8	Roller shutter curtains for the mini, maxi and new building sector.....	93
9	Final slats, buffers, stoppers, angle stop, final inserts	105
10	Steel shafts, telescope shafts, shaft bolts, intermediate supports and security springs	117
11	Pulleys, coilers, belt drives, roll bearings, roller caps, adapter and accessories	123
12	Drives, crank drives and accessories	143
13	Insect repelling system for roller shutters and venetian blinds	165
14	ALUKON insect repelling system AL-IS	183
15	Protection against burglary	217
16	ZipTex for textile shadowing or blackout effect.....	231
17	Venetian blinds	257
18	Top-mounted shutter portfolio AK-E Easy Box and AK-MIRO PLUS out of PVC and accessories	277
19	Foamed top-mounted box AK-FLEX and renovation box AK-FENRO	305

COMPONENTS FOR THE FABRICATION OF ROLLER DOORS

1	Boxes, end caps, automatic start mechanism, guide rolls	333
2	Guide channels and mounting angles	339
3	Roller door profiles, vision windows, ventilation grill, locking clips	347
4	Curtains for roller doors.....	359
5	Final slats and safety switch-off device.....	363
6	Steel shafts, suspensions, shaft bolts, welding shafts, flange support and accessories ...	371
7	Tubular drives, electric drives, safety brakes and accessories	379

1 ROLLGEFORMTE KÄSTEN

Caissons profilés

Roll formed boxes

Válcované schránky

Skrzynki gięte (profilowane)

Gerolvormde aluminium kasten

Hajlított tokok

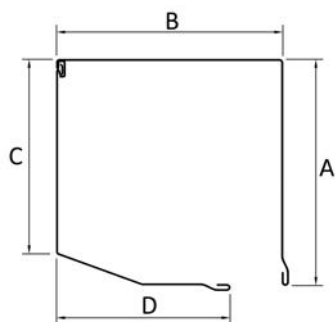

- the original with our high-quality hinge
- made of roll formed and edged aluminium
- stove enamel finished surface
- supplied with easily removable protection film(should be removed immediately after installation)
- box closed

*Please note: not available in all colours - see technical overview: roll formed boxes.

Box size 100 in nougat brown, natural and white mat 9016 only available without protection film, at a surcharge.

size	GOT		GUTS	
	A	B	C	D
100	102	102	88	63
125	127	127	108	88
138	139	139	117	99
150	153	153	129	113
165	168	168	145	128
180	184	184	156	143
205	210	210	179	170

available colours with colour no.

00 mill-finished (without protection film)

standard colours (no RAL)

08 silver
21 brown SF

26 white mat 9016
82 charcoal

trend colours

02 agate grey
03 nougat brown

18 DB 703

RAL

99 RAL (without protection film)

List of articles including prices in €/m

description	part number + colour number (...)	packing unit m	mill-finished	standard colours	trend colours	DB 703	RAL
GOT 100*	0310010..	30			---	---	
GUTS-20° 100*	0310040..	30			---	---	
GOT 125*	0312510..	30				---	
GUTS-20° 125*	0312540..	30				---	
GOT 138	0313810..	30					
GUTS-20° 138	0313840..	30					
GOT 150	0315010..	30					
GUTS-20° 150	0315040..	30					
GOT 165	0316510..	30					
GUTS-20° 165	0316540..	30					
GOT 180	0318010..	30					
GUTS-20° 180	0318040..	30					
GOT 205*	0320510..	30					
GUTS-20° 205*	0320540..	30					

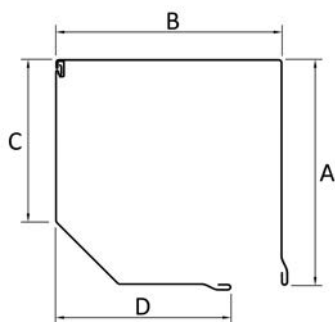

- the original with our high-quality hinge
- made of roll formed and edged aluminium
- stove enamel finished surface
- supplied with easily removable protection film(should be removed immediately after installation)
- box closed

*Please note: not available in all colours - see technical overview: roll formed boxes.

** Lower box part for elements with integrated insect repelling system.

For elements with integrated insect repelling system in box sizes 165, 180 und 205, cover GSUT can be used.

size	GOT		GSUT		GSUT-I **	
	A	B	C	D	C	D
125	127	127	96	88	---	---
138	139	139	103	104	102	95
150	153	153	112	116	111	111
165	169	169	121	126	---	---
180	184	184	133	145	---	---
205	209	209	151	168	---	---
230	232	230	162	186	---	---
254	254	253	176	193	---	---

available colours with colour no.

00 mill-finished (without protection film)

standard colours (no RAL)

08 silver
21 brown SF

26 white mat 9016
82 charcoal

trend colours

02 agate grey
03 nougat brown
18 DB 703

27 creamwhite
43 quartz grey
80 golden oak

RAL

99 RAL (without protection film)

List of articles including prices in €/m

description	part number + colour number (...)	packing unit m	mill-finished	standard colours	trend colours	golden oak	DB 703	RAL
GOT 125*	0312510..	30				---	---	
GSUT-45° 125*	0312550..	30				---	---	
GOT 138*	0313810..	30						
GSUT-45° 138*	0313850..	30						
GSUT-I-45° 138*	0313851..	30			---	---	---	
GOT 150	0315010..	30						
GSUT-45° 150	0315050..	30						
GSUT-I-45° 150*	0315051..	30			---	---	---	
GOT 165	0316510..	30						
GSUT-45° 165	0316550..	30						
GOT 180	0318010..	30						
GSUT-45° 180	0318050..	30						
GOT 205	0320510..	30						
GSUT-45° 205	0320550..	30						
GOT 230*	0423010..	6			---	---	---	
GSUT-45° 230*	0423050..	6			---	---	---	
GOT 254*	0425410..	6			---	---	---	
GSUT-45° 254*	0425450..	6			---	---	---	

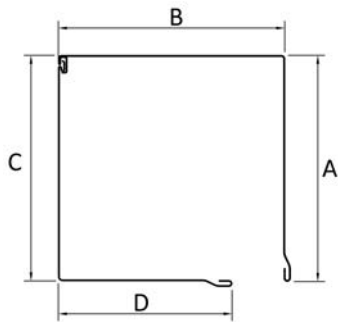

- the original with our high-quality hinge
- made of roll formed and edged aluminium
- stove enamel finished surface
- supplied with easily removable protection film(should be removed immediately after installation)
- box closed

*Please note: not available in all colours - see technical overview: roll formed boxes.

size	G O T		G U T	
	A	B	C	D
100	102	102	102	65
125	127	127	127	86
138	139	139	139	101
150	153	153	153	112
165	168	168	168	127
180	184	184	184	142
205	209	209	209	172

available colours with colour no.

00 mill-finished (without protection film)

standard colours (no RAL)

26 white mat 9016

RAL

99 RAL (without protection film)

List of articles including prices in €/m

description	part number + colour number (...)	packing unit m	mill-finished	standard colours	RAL
GOT 100	0310010..	30			
GUT 100	0310030..	30		---	
GOT 125	0312510..	30			
GUT 125	0312530..	30			
GOT 138	0313810..	30			
GUT 138	0313830..	30			
GOT 150	0315010..	30			
GUT 150	0315030..	30			
GOT 165	0316510..	30			
GUT 165	0316530..	30			
GOT 180	0318010..	30			
GUT 180	0318030..	30			
GOT 205	0320510..	30			
GUT 205	0320530..	30			

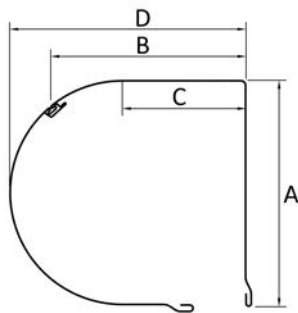

- the original with our high-quality hinge
- made of roll formed and edged aluminium
- stove enamel finished surface
- supplied with easily removable protection film(should be removed immediately after installation)
- box closed

*Please note: not available in all colours - see technical overview: roll formed boxes.

Box size 138 and 150 in cream white is only available without protection film, at a surcharge

size	R O S			R U S
	A	B	C	D
138	141	118	78	148
150	152	131	84	160
165	169	143	92	176
180	183	156	99	191
205	210	179	113	219

available colours with colour no.

00 mill-finished (without protection film)

standard colours (no RAL)

08 silver
21 brown SF

26 white mat 9016
82 charcoal

trend colours

27 creamwhite

RAL

99 RAL (without protection film)

List of articles including prices in €/m

description	part number + colour number (...)	packing unit m	mill-finished	standard colours	trend colours	RAL
ROS 138*	2513842..	18			---	
RUS 138*	2513852..	18			---	
ROS 150*	2515042..	18				
RUS 150*	2515052..	18				
ROS 165	2516542..	18				
RUS 165	2516552..	18				
ROS 180	2518042..	18				
RUS 180	2518052..	18				
ROS 205	2520542..	18				
RUS 205	2520552..	18				

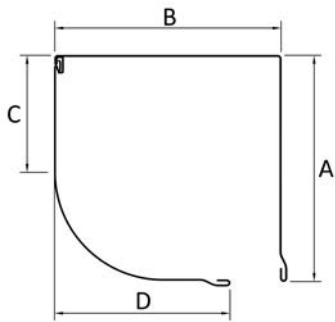

- the original with our high-quality hinge
- made of roll formed and edged aluminium
- stove enamel finished surface
- supplied with easily removable protection film (should be removed immediately after installation)
- box closed

size	GOT		VRB	
	A	B	C	D
138	139	139	70	101
150	153	153	76	115
165	169	169	87	130
180	184	184	92	145
205	209	209	106	166

available colours with colour no.

00 mill-finished (without protection film)

standard colours (no RAL)

08 silver
21 brown SF

26 white mat 9016
82 charcoal

trend colours

43 quartz grey
80 golden oak

RAL

99 RAL (without protection film)

List of articles including prices in €/m

description	part number + colour number (...)	packing unit m	mill-finished	standard colours	trend colours	golden oak	RAL
GOT 138	0313810..	30			---		
VRB 138	2513881..	30			---		
GOT 150	0315010..	30				---	
VRB 150	2515081..	30				---	
GOT 165	0316510..	30					
VRB 165	2516581..	30					
GOT 180	0318010..	30				---	
VRB 180	2518081..	30				---	
GOT 205	0320510..	30					
VRB 205	2520581..	30					

2 STRANGGEPRESSTE KÄSTEN

Caissons extrudés

Extruded boxes

Protlačované schránky

Skrzynki tłoczone (ekstrudowane)

Geëxtrudeerde aluminium kasten

Extrudált tokok

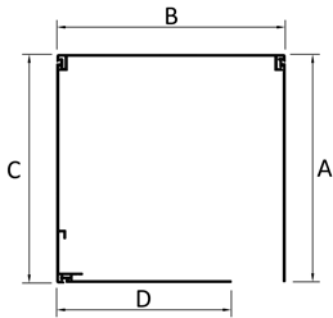

- made of extruded aluminium
- powder-coated or anodized surface
- without protection film
- three-parts (OT/VB-90°/RR), to be used as left roller element
- four-parts (RR/OT/VB-90°/RR), to be used as left and right roller element

Please note: There is no stock service in bronze anodized BC 4 and C 33. A certain delivery time should be accepted.

	RR	OT	VB-90°	RR
size	A	B	C	D
138	139	139	139	90
150	153	153	153	103
165	168	168	168	127
180	184	184	184	139
205	209	209	209	168

Stock service only for mill-finished boxes.

available colours with colour no.

00 mill-finished

ELOX

41 silver anod. EV 1

55 bronze anod. C 33

51 bronze anod. BC 4

RAL

99 RAL (without protection film)

List of articles including prices in €/m

description	part number + colour number (...)	packing unit m	mill-finished	standard colours	silver anod.	bronze anod.	RAL
RR o.T. 138	0113831..	30					
OT 138	0113810..	30					
VB-90° 138	0113820..	30			---	---	
RR o.T. 90	0109031..	30					
RR o.T. 150	0115031..	30					
OT 150	0115010..	30					
VB-90° 150	0115020..	30			---	---	
RR o.T. 100	0110031..	30					
RR o.T. 165	0116531..	30					
OT 165	0116510..	30					
VB-90° 165	0116520..	30			---	---	
RR o.T. 125	0112531..	30					
RR o.T. 180	0118031..	12					
OT 180	0118010..	12					
VB-90° 180	0118020..	12			---	---	
RR o.T. 138	0113831..	12					
RR o.T. 205	0120531..	12					
OT 205	0120510..	12					
VB-90° 205	0120520..	12			---	---	
RR o.T. 165	0116531..	12					

3 PUTZTRÄGERKÄSTEN

KASTENABSCHLUSSPROFIL, WINKEL UND PUTZTRÄGERPLATTEN

Caissons support d'enduit, profil de terminaison,
angles et panneaux de support

Built-in boxes, end profile KAP, angles and concealed rails

Schránky k omítnutí, omít. lišty, úhelníky, heraklitové a izolační desky

Skrzynki podtynkowe, profil zamykający/nośnik tynku,
kątowniki oraz płyty do otynkowania

Inbouw-stuc-kasten, kast afdichtingsprofiel, inbouw-stuc-geleiders,
hoeklijnen, afdek-stuc-platen

Vakolható tokok, tokzáró profil, „L“ Profilok és vakoló lapok

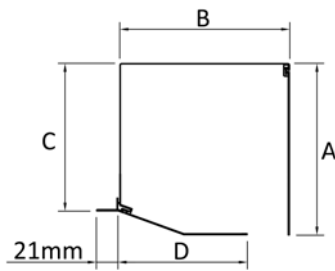

Box part PB-Uni

- made of edged aluminium
- stove enamel finished surface

Access flap RK / plate RR

- made of extruded aluminium
- powder-coated or anodized surface
- without protection film

Please note: There is no stock service for access plate RK in bronze anodized BC 4 and C 33. A certain delivery time should be accepted. Brown SF is generally used as basic colour for golden oak lamination.

	RR	PB - Uni			RK
size	A	B	C	D	
125	127	127	108	86	
138	139	139	117	99	
150	153	153	129	112	
165	168	168	145	126	
180	184	184	156	144	
205	210	210	176	164	

The built-in cover PB-Uni is supplied in different colours, due to invisible installation.

For required end profile PS-V 20° please refer to page 3.5.

available colours of access plate RR + RK with colour no.

00 mill-finished

standard colours (no RAL)

21 brown SF 26 white mat 9016

ELOX

41 silver anod. EV 1 55 bronze anod. C 33
51 bronze anod. BC 4

laminated

80 golden oak (laminated) 88 walnut (laminated)

RAL

99 RAL (without protection film)

List of articles including prices in €/m

description	part number + colour number (...)	packing unit m	mill-finished	standard colours	silver anod.	bronze anod.	RAL	golden oak walnut
PB-Uni 125	031256401	30	---		---	---	---	---
RK-20° 125	0212520..	30						---
RR o.T. 125	0112531..	30						---
PB-Uni 138	031386401	30	---		---	---	---	---
RK-20° 138	0213820..	30						---
RR o.T. 138	0113831..	30						---
PB-Uni 150	031506401	30	---		---	---	---	---
RK-20° 150	0215020..	30						---
RR o.T. 150	0115031..	30						---
PB-Uni 165	031656401	30	---		---	---	---	---
RK-20° 165	0216520..	30						---
RR o.T. 165	0116531..	30						---
PB-Uni 180	031806401	30	---		---	---	---	---
RK-20° 180	0218020..	12						---
RR o.T. 180	0118031..	12						---
PB-Uni 205	032056401	30	---		---	---	---	---
RK-20° 205	0220520..	12						---
RR o.T. 205	0120531..	12						---

BOX PARTS FOR EXTRUDED BUILT-IN BOX, BEVELLED VERSION 20°

ALUKON

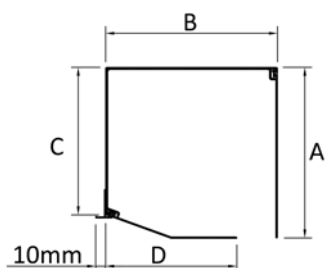

- made of extruded aluminium
- powder-coated or anodized surface
- without protection film

Please note: There is no stock service for access plate RK in bronze anodized BC 4 and C 33. A certain delivery time should be accepted. Brown SF is generally used as basic colour for golden oak lamination.

	RR	WB		RK
size	A	B	C	D
125	127	127	111	85
138	139	139	120	99
150	153	153	132	112
165	168	168	148	129
180	184	184	159	144

For required end profile KAP 6/8 please refer to page 3.5., for the aluminium angles please refer to page 3.6.

	RR	OT	VB	RK
size	A	B	C	D
205	210	210	171	164

available colours with colour no.

00 mill-finished

standard colours (no RAL)

21 brown SF 26 white mat 9016

ELOX

41 silver anod. EV 1 55 bronze anod. C 33
51 bronze anod. BC 4

laminated

80 golden oak (laminated) 88 walnut (laminated)

RAL

99 RAL (without protection film)

List of articles including prices in €/m

description	part number + colour number (...)	packing unit m	mill-finished	standard colours	silver anod.	bronze anod.	RAL	golden oak walnut
WB 125	0212510..	30						---
RK-20° 125	0212520..	30						---
RR o.T. 125	0112531..	30						---
WB 138	0213810..	30						---
RK-20° 138	0213820..	30						---
RR o.T. 138	0113831..	30						---
WB 150	0215010..	30						---
RK-20° 150	0215020..	30						---
RR o.T. 150	0115031..	30						---
WB 165	0216510..	30						---
RK-20° 165	0216520..	30						---
RR o.T. 165	0116531..	30						---
WB 180	0218010..	12						---
RK-20° 180	0218020..	12						---
RR o.T. 180	0118031..	12						---
OT 205	0120510..	12						---
VB-20° 205	0220511..	12						---
RK-20° 205	0220520..	12						---
RR o.T. 205	0120531..	12						---

BOX PARTS FOR ROLL FORMED BUILT-IN BOX

RECTANGULAR VERSION 90°

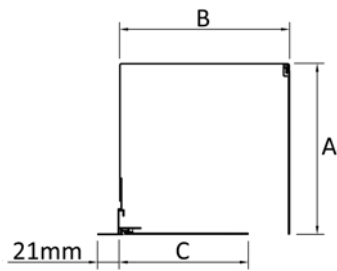
ALUKON

Box part PB-Uni

- made of roll formed and edged aluminium
- stove enamel finished surface

Access plate RR / plate RR

- made of extruded aluminium
- powder-coated or anodized surface
- without protection film

The built-in cover PB-Uni is supplied in different colours, due to invisible installation.

	RR	P B - U n i	RR
size	A	B	C
125	127	127	91
138	139	139	105
150	153	153	105
165	168	168	130
180	184	184	143

available colours of access plate RR with colour no.

00 mill-finished

standard colours (no RAL)

21 brown SF

26 white mat 9016

ELOX

41 silver anod. EV 1

55 bronze anod. C 33

51 bronze anod. BC 4

laminated

80 golden oak (laminated)

RAL

99 RAL (without protection film)

List of articles including prices in €/m

description	part number + colour number (...)	packing unit m	mill-finished	standard colours	silver anod.	bronze anod.	RAL	golden oak
PB-Uni 125	031256401	30	---		---	---	---	---
RR o.T. 90	0109031..	30						---
RR o.T. 125	0112531..	30						---
PB-Uni 138	031386401	30	---		---	---	---	---
RR o.T. 100 (RR 90 - A 15/A 20)	0110031..	30						
RR o.T. 138	0113831..	30						
PB-Uni 150	031506401	30	---		---	---	---	---
RR o.T. 100	0110031..	30						
RR o.T. 150	0115031..	30						---
PB-Uni 165	031656401	30	---		---	---	---	---
RR o.T. 125	0112531..	30						
RR o.T. 165	0116531..	30						---
PB-Uni 180	031806401	30	---		---	---	---	---
RR o.T. 138	0113831..	30						
RR o.T. 180	0118031..	12						---

BOX PARTS FOR EXTRUDED BUILT-IN BOX, RECTANGULAR VERSION 90°

ALUKON

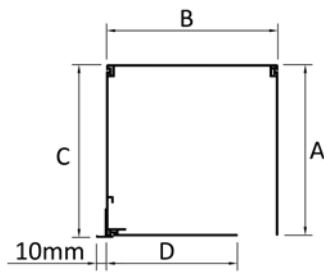

- made of extruded aluminium
- powder-coated or anodized surface
- without protection film

Please note: There is no stock service for access plate RK in bronze anodized BC 4 and C 33. A certain delivery time should be accepted. Brown SF is generally used as basic colour for golden oak lamination.

	RR	OT	VB - 90°	RR
size	A	B	C	D
138	139	139	139	90
150	153	153	153	103
165	168	168	168	127
180	184	184	184	139
205	209	209	209	168

For required end profile KAP 6/8 please refer to page 3.5.

Stock service only for mill-finished boxes.

available colours of access plate RR with colour no.

00 mill-finished

ELOX

41 silver anod. EV 1

55 bronze anod. C 33



51 bronze anod. BC 4

RAL



99 RAL (without protection film)

List of articles including prices in €/m

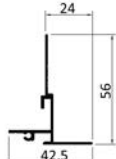
description	part number + colour number (...)	packing unit m	mill-finished	standard colours	silver anod.	bronze anod.	RAL
RR o.T. 138	0113831..	30					
OT 138	0113810..	30					
VB-90° 138	0113820..	30			---	---	
RR o.T. 90	0109031..	30					
RR o.T. 150	0115031..	30					
OT 150	0115010..	30					
VB-90° 150	0115020..	30			---	---	
RR o.T. 100	0110031..	30					
RR o.T. 165	0116531..	30					
OT 165	0116510..	30					
VB-90° 165	0116520..	30			---	---	
RR o.T. 125	0112531..	30					
RR o.T. 180	0118031..	12					
OT 180	0118010..	12					
VB-90° 180	0118020..	12			---	---	
RR o.T. 138	0113831..	30					
RR o.T. 205	0120531..	12					
OT 205	0120510..	12					
VB-90° 205	0120520..	12			---	---	
RR o.T. 165	0116531..	30					

	Product description	article no.	p.u. m	Unit	price €
	End profile KAP 6/8				
	mill-finished	190230000	60	m	
	standard colours	1902300..	60	m	
	26 white 9016 mat				
	silver anodized EV 1	190230041	60	m	
	bronze anodized BC 4 ..51, C 33 ..55	1902300..	60	m	
	RAL	190230099	60	m	
	golden oak (laminated) Renolit-No 2178 001	190230080	60	m	
	End profile PS-V 20° (for Heraklith panel or heat insulation)				
	mill-finished	190220000	60	m	
	standard colours	1902200..	60	m	
	21 brown SF				
	26 white 9016 mat				
	silver anodized EV 1	190220041	60	m	
	bronze anodized BC 4 ..51, C 33 ..55	1902200..	60	m	
	RAL	190220099	60	m	
golden oak (single-sided lamination) Renolit-No 2178 001	190220080	60	m		
walnut (laminated) Renolit no. 2178 707	190220088	60	m		
	End profile PS-V 90° (for Heraklith panel or heat insulation)				
	mill-finished	190250000	60	m	
	standard colours	1902500..	60	m	
	21 brown SF				
	26 white 9016 mat				
	silver anodized EV 1	190250041	60	m	
	bronze anodized BC 4 ..51, C 33 ..55	1902500..	60	m	
	RAL	190250099	60	m	
golden oak (laminated) Renolit-No 2178 001	190250080	60	m		

Please note: There is no stock service for end profiles in bronze anodized BC 4 and C 33. A certain delivery time should be accepted. Brown SF is generally used as basic colour for golden oak lamination.

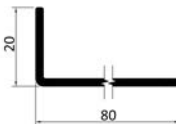
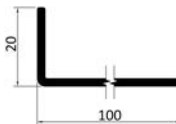
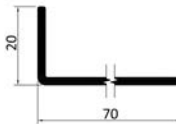
	Product description	article no.	p.u. m	Unit	price €	
	Aluminium angle 30 x 20 x 2 mm (for Heraklith panel or heat insulation)					
	mill-finished	190100000	60	m		
	standard colours	1901000..	60	m		
	03 nougat brown 08 silver	21 brown SF 26 white 9016 mat				
	silver anodized EV 1	190100041	60	m		
	bronze anodized BC 4 ..51, C 33 ..55	1901000..	60	m		
	RAL	190100099	60	m		
	Aluminium angle 50 x 25 x 2 mm (for Heraklith panel or heat insulation)					
	mill-finished	190103000	60	m		
	standard colours	1901030..	60	m		
	26 white 9016 mat					
	silver anodized EV 1	190103041	60	m		
	bronze anodized BC 4 ..51, C 33 ..55	1901030..	60	m		
	RAL	190103099	60	m		
	Aluminium angle 60 x 20 x 2 mm (for Heraklith panel or heat insulation)					
	mill-finished	190104000	60	m		
	standard colours	1901040..	60	m		
	26 white 9016 mat					
	silver anodized EV 1	190104041	60	m		
	bronze anodized BC 4 ..51, C 33 ..55	1901040..	60	m		
	RAL	190104099	60	m		
	Aluminium angle 80 x 20 x 2 mm (for Heraklith panel or heat insulation)					
	mill-finished	190105000	60	m		
	standard colours	1901050..	60	m		
	26 white 9016 mat					
	silver anodized EV 1	190105041	60	m		
	bronze anodized BC 4 ..51, C 33 ..55	1901050..	60	m		
	RAL	190105099	60	m		
	Aluminium angle 100 x 20 x 2 mm (for Heraklith panel or heat insulation)					
	mill-finished	190106000	60	m		
	standard colours	1901060..	60	m		
	26 white 9016 mat					
	silver anodized EV 1	190106041	60	m		
	bronze anodized BC 4 ..51, C 33 ..55	1901060..	60	m		
	RAL	190106099	60	m		
	Aluminium angle 70 x 20 x 2 mm (for Heraklith panel or heat insulation)					
	mill-finished	190120000	60	m		
	standard colours	1901200..	60	m		
	26 white 9016 mat					
	silver anodized EV 1	190120041	60	m		
	bronze anodized BC 4 ..51, C 33 ..55	1901200..	60	m		
	RAL	190120099	60	m		

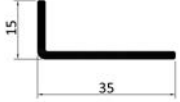
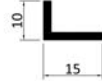
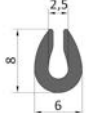
	Product description	article no.	p.u. m	Unit	price €
	Aluminium angle 40 x 15 x 2 mm (for Heraklith panel or heat insulation)				
	mill-finished	190130100	60	m	
	standard colours	1901301..	60	m	
	26 white 9016 mat				
	silver anodized EV 1	190130141	60	m	
	bronze anodized BC 4 ..51, C 33 ..55	1901301..	60	m	
	RAL	190130199	60	m	
	Aluminium angle 35 x 15 x 2 mm (for Heraklith panel or heat insulation)				
	mill-finished	190160000	60	m	
	standard colours	1901600..	60	m	
	26 white 9016 mat				
	silver anodized EV 1	190160041	60	m	
	RAL	190160099	60	m	
	Aluminium angle 15 x 10 x 2 mm (for Heraklith panel or heat insulation)				
	mill-finished	190140000	60	m	
	standard colours	1901400..	60	m	
	26 white 9016 mat				
	silver anodized EV 1	190140041	60	m	
	RAL	190140099	60	m	
	U-shaped sealing profile 6x8 mm				
	TPE black	810080004	100	m	

Please note: There is no stock service for end profiles in bronze anodized BC 4 and C 33. A certain delivery time should be accepted. Brown SF is generally used as basic colour for golden oak lamination.

COVERS FOR BUILT-IN UNITS AND HERAKLITH TILES AND ISOLATION XPS WITH SINGLE-SIDED ADHESIVE

ALUKON

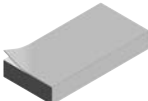

	Product description	article no.	p.u. m	Unit	price €
	Isolation XPS, 2000 x 500 x 6 mm				
	Application: in front of box, isolation of the rear side of the box	190720300	2	m	
	Isolation XPS, 3000 x 500 x 10 mm				
	Application: in front of box, without, isolation of the rear side of the box	190700211	3	m	
	Isolation XPS, 2000 x 500 x 015 mm				
	Application: plaster base plate, isolation of the rear side of the box	190720400	2	m	
	Isolation XPS, 2000 x 500 x 19 mm				
	Application: isolation of the rear side of the box, TGF	190700200	2	m	
Isolation XPS, 3000 x 500 x 40 mm					
Application: isolation of the rear side of the box	190700241	3	m		

MOUNTING LUG AND STIFFENING ANGLES

FOR BUILT-IN BOXES

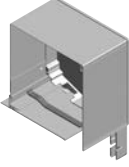
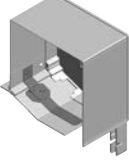
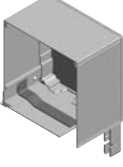
ALUKON

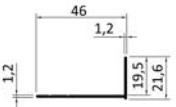
	Product description	article no.	p.u. m	Unit	price €
	Mounting lug for built-in boxes - to mount the box on the wall				
		190290200	50	pce	
	Stiffening angle PT 90° for PB-Uni in combination with access flap RR, one-piece for RR 90				
	for RR 90	190294100	1	pce	
	for RR 100	190294200	1	pce	
	for RR 125	190294300	1	pce	
	for RR 138	190294400	1	pce	
	Stiffening angle PT 20° for RK, two-parts				
	125	190292100	1	pce	
	138	190292200	1	pce	
	150	190292300	1	pce	
	165	190292400	1	pce	
	180	190292500	1	pce	
	205	190292600	1	pce	
	Stiffening angle VB-90° (for front-mounted and built-in units 90° extruded boxes), one-piece				
	138	190293100	1	pce	
	150	190293500	1	pce	
	165	190293200	1	pce	
	180	190293300	1	pce	
	205	190293400	1	pce	

	Product description	article no.	p.u. m	Unit	price €
	TGF 20*				
	mill-finished	112000000	60	m	
	standard colours	1120000..	60	m	
	silver anodized EV 1	112000041	60	m	
	bronze anodized BC 4 ..51, C 33 ..55	1120000..	60	m	
	RAL	112000099	60	m	
	Distance sleeve 5,1 x 9,5 x 19,1				
	grey	199000300	100	pce	

*To rivet on the guide channel or rear plate of the extruded box. Stock service only for mill-finished profiles. For coated profiles a certain delivery time should be accepted.

4 **BLENDKAPPEN** ABWEISBLECHE UND EINLAUFTRICHTER

Consoles, plaques de déviation et entonnoirs

End caps, safety plates and guide terminals

Bočnice, vymešovací podložky a náběhy

Boczki skrzynek, blachy boczne i ślizgacze

Kapsteunen, arreterplaten en inlooptrechters

Tokvégek, terelőlapok és lécevezetők

PRESSURE MOULDED END CAPS

BEVELLED VERSION 20°

ALUKON

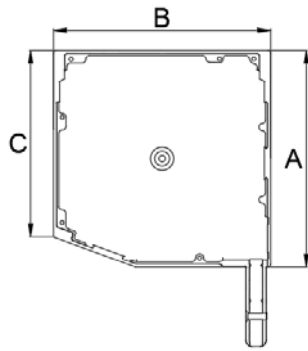

- made of a special aluminium alloy
- pressure moulded (cannot be anodized)
- end caps will be delivered in pairs only
- the listed standard colours are no RAL colours

✓ colours in stock

BKS-N	dimen- sions in mm		standard colours							bronze	
	A	C	00	03	08	21	26	82	09	25	99
100	102	88	✓	✓	✓	✓	✓	✓			
125	127	108	✓	✓	✓	✓	✓	✓		✓	
138	139	117	✓	✓	✓	✓	✓	✓	✓	✓	
150	153	129	✓	✓	✓	✓	✓	✓		✓	
165	168	145	✓	✓	✓	✓	✓	✓	✓	✓	
180	184	156	✓	✓	✓	✓	✓	✓			
205	210	179	✓		✓	✓	✓	✓			

available colours with colour no.

00 mill-finished

standard colours (no RAL)

03 nougat brown 26 white mat 9016
 08 silver 82 charcoal
 21 brown SF

bronze

09 coated similar BC 4 25 coated similar C 33

RAL

99 RAL

List of articles including prices in €/pair

description	part number + colour num- ber (...)	packing unit pair	mill-fin- ished	standard colours	bronze	RAL
BKS-N 100	2310010..	10				
BKS-N 125	2312010..	10				
BKS-N 138	2313010..	10				
BKS-N 150	2315010..	10				
BKS-N 165	2316010..	10				
BKS-N 180	2318010..	10				
BKS-N 205	2320010..	10				

PRESSURE MOULDED END CAPS

BEVELLED VERSION 45°

ALUKON

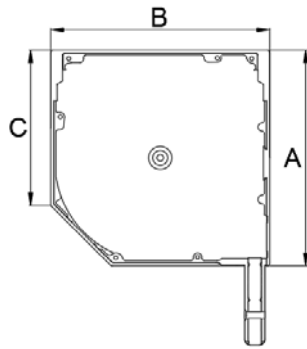

- made of a special aluminium alloy
- pressure moulded (cannot be anodized)
- end caps will be delivered in pairs only
- the listed standard colours are no RAL colours

✓ colours in stock

BKS-N	dimen- sions in mm		standard colours										
	A	C	00	03	08	21	26	27	43	82	86	80	99
125	127	96	✓		✓	✓	✓			✓			
138	139	103	✓	✓	✓	✓	✓			✓	✓	✓	
150	153	112	✓	✓	✓	✓	✓	✓	✓	✓	✓		
165	169	121	✓	✓	✓	✓	✓	✓	✓	✓	✓	✓	
180	184	133	✓	✓	✓	✓	✓	✓	✓	✓	✓	✓	
205	209	151	✓	✓	✓	✓	✓	✓	✓	✓	✓	✓	
230	232	162	✓			✓	✓						
254	254	176	✓			✓	✓						

available colours with colour no.

00 mill-finished

standard colours (no RAL)

03 nougat brown	27 creamwhite
08 silver	43 quartz grey
21 brown SF	82 charcoal
26 white mat 9016	86 clay brown 8003 mat

laminated

80 golden oak

RAL

99 RAL

List of articles including prices in €/pair

description	part number + colour num- ber (...)	packing unit pair	mill-fin- ished	standard colours	golden oak (laminated)	RAL
BKS-N 125	2312050..	10			---	
BKS-N 138	2313050..	10				
BKS-N 150	2315050..	10			---	
BKS-N 165	2316050..	10				
BKS-N 180	2318050..	10			---	
BKS-N 205	2320050..	10				
BKS-N 230	0823000..	6			---	
BKS-N 254	0825400..	6			---	

PRESSURE MOULDED END CAPS

RECTANGULAR VERSION 90°

ALUKON

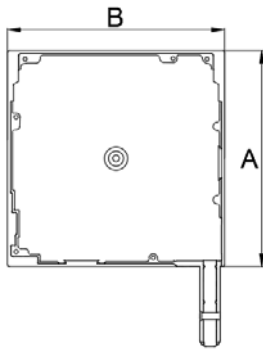

- made of a special aluminium alloy
- pressure moulded (cannot be anodized)
- end caps will be delivered in pairs only
- the listed standard colours are no RAL colours

✓ colours in stock

BK-N	dimen- sions in mm	standard colours				
		00	08	21	26	99
100	102	✓				
125	127	✓	✓	✓	✓	
138	139	✓	✓	✓	✓	
150	153	✓	✓	✓	✓	
165	168	✓	✓	✓	✓	
180	184	✓	✓	✓	✓	
205	209	✓	✓	✓	✓	

available colours with colour no.

00 mill-finished

standard colours (no RAL)

08 silver

26 white mat 9016

21 brown SF

RAL

99 RAL

List of articles including prices in €/pair

description	part number + colour number (...)	packing unit pair	mill-finished	standard colours	RAL
BK-N 100	2310020..	10			
BK-N 125	2312020..	10			
BK-N 138	2313020..	10			
BK-N 150	2315020..	10			
BK-N 165	2316020..	10			
BK-N 180	2318020..	10			
BK-N 205	2320020..	10			

PRESSURE MOULDED END CAPS

ROUND VERSION

ALUKON

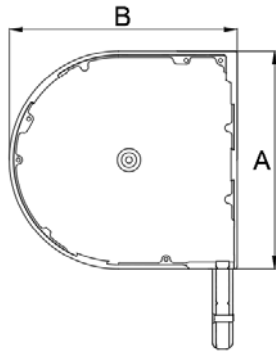

- made of a special aluminium alloy
- pressure moulded (cannot be anodized)
- end caps will be delivered in pairs only
- the listed standard colours are no RAL colours

✓ colours in stock

BKR-N	dimen- sions in mm		standard colours									bronz e	
	A	B	00	03	08	21	26	27	82	09	25	99	
138	141	148	✓	✓	✓	✓	✓		✓				
150	152	160	✓	✓	✓	✓	✓	✓	✓				
165	169	176	✓	✓	✓	✓	✓	✓	✓				
180	183	191	✓	✓	✓	✓	✓	✓	✓				
205	210	219	✓	✓	✓	✓	✓		✓				

available colours with colour no.

00 mill-finished

standard colours (no RAL)

03 nougat brown	26 white mat 9016
08 silver	27 creamwhite
21 brown SF	82 charcoal

bronze

09 coated similar BC 4	25 coated similar C 33
------------------------	------------------------

RAL

99 RAL

List of articles including prices in €/pair

description	part number + colour num- ber (...)	packing unit pair	mill-fin- ished	standard colours	bronze	RAL
BKR-N 138	2313030..	10				
BKR-N 150	2315030..	10				
BKR-N 165	2316030..	10				
BKR-N 180	2318030..	10				
BKR-N 205	2320030..	10				

PRESSURE MOULDED END CAPS

QUARTER ROUND VERSION

ALUKON

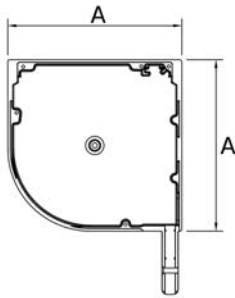

- made of a special aluminium alloy
- pressure moulded (cannot be anodized)
- end caps will be delivered in pairs only
- the listed standard colours are no RAL colours

✓ colours in stock

BKVR -N	dime nsio ns in mm	standard colours						
		A	00	08	21	26	43	82
138	139	✓	✓	✓	✓		✓	
150	153	✓	✓	✓	✓	✓	✓	
165	169	✓	✓	✓	✓	✓	✓	
180	184	✓	✓	✓	✓	✓	✓	
205	209	✓	✓			✓	✓	✓

available colours with colour no.

00 mill-finished

standard colours (no RAL)

08 silver
21 brown SF
26 white mat 9016

43 quartz grey
82 charcoal

RAL

99 RAL

List of articles including prices in €/pair

description	part number + colour number (...)	packing unit pair	mill-finished	standard colours	RAL
BKVR-N 138	2313040..	10			
BKVR-N 150	2315040..	10			
BKVR-N 165	2316040..	10			
BKVR-N 180	2318040..	10			
BKVR-N 205	2320040..	10			

PRESSURE MOULDED END CAPS

CENTRAL END CAP FOR COMBINATIONS

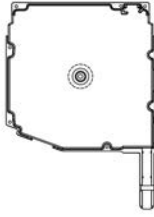

ALUKON





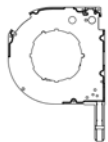
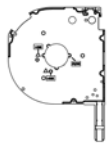
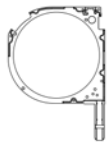

- without edge
- available with or without pin
- delivery in RAL 9005 mat or mill-finished
- guide channel terminal and additional pins have to be ordered separately

description	Part no. + color no. left side	Part no. + color no. right side	pce	mill-fin- ished	schwarz 9005 matt
MBK 100 with pin	2310001..02	2310002..02	5		
MBK 125 with pin	2312001..02	2312002..02	5		
MBK 138 with pin	2313001..02	2313002..02	5		
MBK 138 without pin	2313001..05	2313002..05	5		
MBK 150 with pin	2315001..02	2315002..02	5		
MBK 150 without pin	2315001..05	2315002..05	5		
MBK 165 with pin	2316001..02	2316002..02	5		
MBK 165 without pin	2316001..05	2316002..05	5		
MBK 180 with pin	2318001..02	2318002..02	5		
MBK 180 without pin	2318001..05	2318002..05	5		
MBK 205 with pin	2320001..02	2320002..02	5		
MBK 205 without pin	2320001..05	2320002..05	5		
MBK 230 with pin	2323001..02	2323002..02	5		
MBK 254 with pin	2325001..02	2325002..02	5		





	Product description	article no.	p.u. m	Unit	price €
	Pin for BKDF for riveting at center caps, will be used when a journal offset of a pin is required or as a double guide channel version				
	Pin for BKDF For clenching at the central end cap. Necessary in case of pin offset or as double guide channel	891200300	1	pce	

	Product description	article no.	p.u. m	Unit	price €
	punched out on the left side for external pulley AGS*	239920200		pce	
	punched out on the right side for external pulley AGS*	239920300		pce	
	punched out and edged for double shaft bolt (60 mm shaft) Ø 40 mm	239920500		pce	
	punched out and edged for intermediate PVC bearing (40 mm shaft) Ø 72 mm	239920600		pce	
	punched out on the left side and edged for steel pulley SGS	239920900		pce	
	punched out on the right side and edged for steel pulley SGS	239921000		pce	
	without plug-in feet	239921200		pce	

*in case of punch out for AGS and box size 165, it is necessary to indicate which box type is used and whether insect repelling system is required.

	Product description	article no.	p.u. m	Unit	price €
	Safety plate Universal steel 40 mm shaft				
	AWB 100 universal, steel	091000000	10	pce	
	AWB 125 universal, steel	091250000	10	pce	
	AWB 138 universal, steel	091380000	10	pce	
	AWB 150 universal, steel	091500000	10	pce	
	AWB 165 universal, steel	091650000	10	pce	
	AWB 180 universal, steel	091800000	10	pce	
	AWB 205 universal, steel	092050000	10	pce	
	Safety plate steel 60 mm shaft				
	AWB 100 universal, steel	091000001	10	pce	
	AWB 125 universal, steel	091250001	10	pce	
	AWB 138 universal, steel	091380001	10	pce	
	AWB 150 universal, steel	091500001	10	pce	
	AWB 165 universal, steel	091650001	10	pce	
	AWB 180 universal, steel	091800001	10	pce	
	AWB 205 universal, steel	092050001	10	pce	
	AWB 230 45°, aluminium	092300001	50	pce	
	AWB 230 45°, PVC	092303272	50	pce	
	AWB 254 45°, aluminium	092540001	50	pce	
	AWB 254 45°, PVC	092543272	50	pce	
	Safety plate for built-in unit Universal aluminium 40 mm shaft				
	AWB-PT 125 universal, aluminium	091250500	10	pce	
	AWB-PT 138 universal, aluminium	091380500	10	pce	
	AWB-PT 150 universal, aluminium	091500500	10	pce	
	AWB-PT 165 universal, aluminium	091650500	10	pce	
	AWB-PT 180 universal, aluminium	091800500	10	pce	
	AWB-PT 205 universal, aluminium	092050500	10	pce	
	safety plate for built-in unit Universal aluminium 60 mm shaft				
	AWB-PT 125 universal, aluminium	091250501	10	pce	
	AWB-PT 138 universal, aluminium	091380501	10	pce	
	AWB-PT 150 universal, aluminium	091500501	10	pce	
	AWB-PT 165 universal, aluminium	091650501	10	pce	
	AWB-PT 180 universal, aluminium	091800501	10	pce	
	AWB-PT 205 universal, aluminium	092050501	10	pce	
	Pine Tree Clip A=3,0, B=14,5				
	black	891195000	100	pce	

	Product description	article no.	p.u. m	Unit	price €
	Guide terminal A 3 including foot - exchangeable for 53 mm guide channel				
	white	059120100	50	pair	
	black	059120200	50	pair	
	Guide terminal A 5 / A 6 including foot - exchangeable for 45 mm guide channel				
	white	059121100	50	pair	
	black	059121200	50	pair	
	Guide terminal A 13 / A 14 including foot - exchangeable for 68 mm guide terminals				
	white	059122100	50	pair	
	black	059122200	50	pair	
	Guide terminal A 15 / A 20 including foot - exchangeable, special edition for distance guide channels A 15/A 20				
	white	059123100	50	pair	
	black	059123200	50	pair	
	guide terminal -upper part for DF A 3 for double channel DF A 3, DF A 3-10-CR, DF A 3-12				
	white, left	239102110	50	pce	
	white, right	239102210	50	pce	
	black, left	239102120	50	pce	
	black, right	239102220	50	pce	
	guide terminal -upper part for DF A 5 for double channel DF A 5				
	white, left	239103110	50	pce	
	white, right	239103210	50	pce	
	black, left	239103120	50	pce	
	black, right	239103220	50	pce	
	Guide channel terminal - upper part for double guide channel DF A 15/20				
	white, left	239104110	50	pce	
	white, right	239104210	50	pce	
	black, left	239104120	50	pce	
	black, right	239104220	50	pce	
	Foot for guide channel terminal - double guide channel				
	white	239101010	100	pce	
	black	239101020	100	pce	
	Drilling template for guide terminal (except guide channel A 20 and A 15) and spring bolt				
		319212200	1	pce	

	Product description	article no.	p.u. m	Unit	price €
	Guide terminal for NB-N 21 mill-finished	059090100	250	pair	
	Guide terminal for NB-N 28 beige	059090200	250	pair	
	Guide terminal connector for NB-N 21 / NB-N 28 left	059090310	150	pce	
	right	059090320	150	pce	
	Guide terminals for NB-N 22 natural	059090400	100	pair	
	Guide terminal plug-in foot for NB-N 22 left	059090410	100	pce	
	right	059090420	100	pce	

5 FÜHRUNGSSCHIENEN

STANDARD- UND SONDERFÜHRUNGSSCHIENEN FÜR DEN MINI- UND MAXIBEREICH

Coulisses standard et spéciales pour le domaine mini et maxi



Standard and special guide channels for the mini and maxi sector

Standardní a zvláštní vod. lišty pro oblast „Mini“ a „Maxi“

Standardowe i specjalne prowadnice roletowe do pancerzy mini i maxi

Standaard- en bijzondere geleiders voor mini en maxi (voorzet) rolluiken

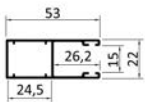
Standard és egyedi vezetősinek a mini és maxi redönyökhöz

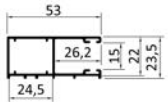
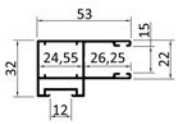
	Product description	article no.	p.u. m	Unit	price €
	Guide channel A 3				
	mill-finished	100300000	72	m	
	standard colours	1003000..	72	m	
	03 nougat brown	27 cream white			
	08 silver	28 fir green			
	21 brown SF	82 charcoal			
	26 white 9016 mat	84 light ivory			
	silver anodized EV 1	100300041	72	m	
	bronze anodized BC 4 ..51, C 33 ..55	1003000..	72	m	
	RAL	100300099	72	m	
	golden oak (single-sided lamination) 2178 001	100300080	72	m	
	golden oak (double-sided lamination) Fb. 2178 001	100300079	72	m	
	Guide channel A 4				
	mill-finished	100400000	36	m	
	standard colours	1004000..	36	m	
	03 nougat brown	27 cream white			
	08 silver	28 fir green			
	21 brown SF	82 charcoal			
	26 white 9016 mat	84 light ivory			
	silver anodized EV 1	100400041	36	m	
	bronze anodized BC 4 ..51, C 33 ..55	1004000..	36	m	
	RAL	100400099	36	m	
	Guide channel A 3-R (stock service only in mill-finished)				
	mill-finished	100315000	72	m	
	standard colours	1003150..	72	m	
	26 white 9016 mat				
	silver anodized EV 1	100315041	72	m	
	bronze anodized BC 4 ..51, C 33 ..55	1003150..	72	m	
	RAL	100315099	72	m	
	Guide channel A 3-10-CR				
	mill-finished	100310000	72	m	
	standard colours	1003100..	72	m	
	silver anodized EV 1	100310041	72	m	
	bronze Anodized BC 4 ..51, C 33 ..55	1003100..	72	m	
RAL	100310099	72	m		

Please note: There is no stock service in bronze anodized BC 4 and C 33. A certain delivery time should be accepted. Brown SF is generally used as basic colour for golden oak lamination. Extra charges for PVC- and brush inserts and protection film please refer to page 5.10.

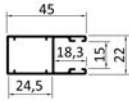
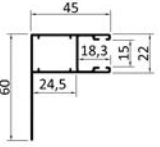
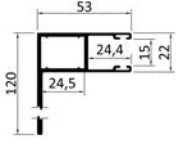
	Product description	article no.	p.u. m	Unit	price €	
	Guide channel A 5					
	mill-finished	110500000	72	m		
	standard colours	1105000..	72	m		
	03 nougat brown 08 silver 21 brown SF	26 white 9016 mat 27 cream white				
	silver anodized EV 1	110500041	72	m		
	bronze anodized BC 4 ..51, C 33 ..55	1105000..	72	m		
	RAL	110500099	72	m		
	Guide channel A 6					
	mill-finished	110600000	36	m		
	standard colours	1106000..	36	m		
	26 white 9016 mat 27 cream white					
	silver anodized EV 1	110600041	36	m		
	bronze anodized BC 4 ..51, C 33 ..55	1106000..	36	m		
	RAL	110600099	36	m		
	Guide channel A 12					
	mill-finished	111200000	30	m		
	standard colours	1112000..	30	m		
	21 brown SF 26 white 9016 mat					
	silver anodized EV 1	111200041	30	m		
	bronze anodized BC 4	111200051	30	m		
	RAL	111200099	30	m		

Please note: There is no stock service in bronze anodized BC 4 and C 33. A certain delivery time should be accepted. Extra charges for PVC- and brush inserts and protection film please refer to page 5.10.

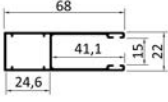
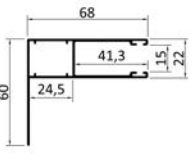

	Product description	article no.	p.u. m	Unit	price €
	Guide channel A 13				
	mill-finished	111300000	36	m	
	standard colours	1113000..	36	m	
	08 silver 21 brown SF	26 white 9016 mat			
	silver anodized EV 1	111300041	36	m	
	bronze anodized BC 4 ..51	1113000..	36	m	
	RAL	111300099	36	m	
	Guide channel A 14				
	mill-finished	111400000	36	m	
	standard colours	1114000..	36	m	
	26 white 9016 mat				
	silver anodized EV 1	111400041	36	m	
	bronze anodized BC 4 ..51	1114000..	36	m	
	RAL	111400099	36	m	

Please note: There is no stock service in bronze anodized BC 4 and C 33. A certain delivery time should be accepted. Extra charges for PVC- and brush inserts and protection film please refer to page 5.10.

SPACE GUIDE CHANNELS FOR USE IN PLUG-IN SYSTEMS

ALUKON

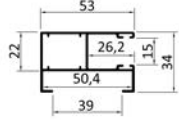
MADE OF EXTRUDED ALUMINIUM

	Product description	article no.	p.u. m	Unit	price €
	Guide channel A 8-12				
	mill-finished	110801200	36	m	
	standard colours	1108012..	36	m	
	silver anodized EV 1	110801241	36	m	
	bronze anodized BC 4 ..51, C 33 ..55	1108012..	36	m	
	RAL	110801299	36	m	
	Guide channel A 8-20				
	mill-finished	110802000	36	m	
	standard colours	1108020..	36	m	
	03 nougat brown	26 white 9016 mat			
	08 silver	27 cream white			
	21 brown SF				
	silver anodized EV 1	110802041	36	m	
	bronze anodized BC 4 ..51, C 33 ..55	1108020..	36	m	
RAL	110802099	36	m		
	Mounting clip				
	made of polyamide	119220100	50	pce	

Please note: There is no stock service in bronze anodized BC 4 and C 33. A certain delivery time should be accepted. Extra charges for PVC- and brush inserts and protection film please refer to page 5.10.

SPACE GUIDE CHANNELS FOR USE IN PLUG-IN SYSTEMS

ALUKON

MADE OF EXTRUDED ALUMINIUM

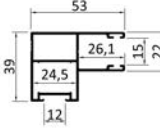
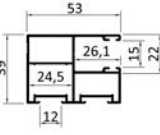
	Product description	article no.	p.u. m	Unit	price €
	Guide channel A 5-12				
	mill-finished	110501200	36	m	
	standard colours	1105012..	36	m	
	26 white 9016 mat				
	silver anodized EV 1	110501241	36	m	
	bronze anodized BC 4 ..51	1105012..	36	m	
	RAL	110501299	36	m	
	Guide channel A 15-CR				
	mill-finished	111515000	48	m	
	standard colours	1115150..	48	m	
	03 nougat brown 08 silver	21 brown SF 26 white 9016 mat			
	silver anodized EV 1	111515041	48	m	
	bronze anodized BC 4 ..51, C 33 ..55	1115150..	48	m	
	RAL	111515099	48	m	
	Guide channel A 16-CR				
	mill-finished	111615000	30	m	
	white mat 9016	111615026	30	m	
	silver anodized EV 1	111615041	30	m	
	bronze anodized BC 4	1116150..	30	m	
	RAL	111615099	30	m	

Guide channels A 15-CR and A 16-CR only for box sizes > 138, max. area 3 m² Please note: There is no stock service in bronze anodized BC 4 and C 33. A certain delivery time should be accepted. Extra charges for PVC- and brush inserts and protection film please refer to page 5.10.

DOUBLE GUIDE CHANNELS FOR USE IN PLUG-IN SYSTEMS

ALUKON



MADE OF EXTRUDED ALUMINIUM

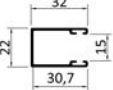

	Product description	article no.	p.u. m	Unit	price €
	Guide channel DF A 3				
	mill-finished	120300000	36	m	
	standard colours	1203000..	36	m	
	03 nougat brown 21 brown SF	26 white 9016 mat			
	silver anodized EV 1	120300041	36	m	
	bronze anodized BC 4 ..51, C 33 ..55	1203000..	36	m	
	RAL	120300099	36	m	
	golden oak (laminated) Renolit-No 2178 001	120300080	36	m	
	Guide channel DF A 3-10-CR				
	mill-finished	120310000	36	m	
	standard colours	1203100..	36	m	
	silver anodized EV 1	120310041	36	m	
	bronze Anodized BC 4 ..51, C 33 ..55	1203100..	36	m	
	RAL	120310099	36	m	
	Guide channel DF A 5				
	mill-finished	120500000	36	m	
	standard colours	1205000..	36	m	
	26 white 9016 mat				
	silver anodized EV 1	120500041	36	m	
	bronze anodized BC 4 ..51, C 33 ..55	1205000..	36	m	
RAL	120500099	36	m		
	Guide channel DF A 3-12				
	mill-finished	120600000	36	m	
	standard colours	1206000..	36	m	
	26 white 9016 mat				
	silver anodized EV 1	120600041	36	m	
	bronze anodized BC 4	120600051	36	m	
RAL	120600099	36	m		
	Guide channel DF A 15-CR				
	mill-finished	121515000	36	m	
	standard colours	1215150..	36	m	
	26 white 9016 mat				
	silver anodized EV 1	121515041	36	m	
	bronze Anodized BC 4 ..51, C 33 ..55	1215150..	36	m	
RAL	121515099	36	m		





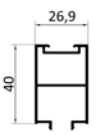

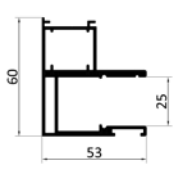
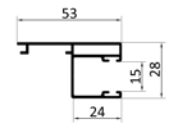
Please note: There is no stock service in bronze anodized BC 4 and C 33. A certain delivery time should be accepted. Brown SF is generally used as basic colour for golden oak lamination. Extra charges for PVC- and brush inserts and protection film please refer to page 5.10.

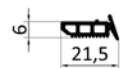
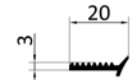
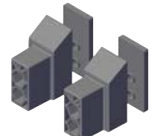
	Product description	article no.	p.u. m	Unit	price €
	Guide channel A 1				
	mill-finished	110100000	72	m	
	standard colours	1101000..	72	m	
	21 brown SF	26 white 9016 mat			
	silver anodized EV 1	110100041	72	m	
	bronze anodized BC 4 ..51, C 33 ..55	1101000..	72	m	
	RAL	110100099	72	m	
	Guide channel A 10				
	mill-finished	111000000	72	m	
	standard colours	1110000..	72	m	
	21 brown SF	26 white 9016 mat			
	silver anodized EV 1	111000041	72	m	
	bronze anodized BC 4 ..51, C 33 ..55	1110000..	72	m	
	RAL	111000099	72	m	

Please note: There is no stock service in bronze anodized BC 4 and C 33. A certain delivery time should be accepted. Extra charges for PVC- and brush inserts and protection film please refer to page 5.10. U-shaped sealing profile 6x8 mm for sealing the distance angle against wall: see chap. 3.7

	Product description	article no.	p.u. m	Unit	price €
	Support profile 10 mm				
	mill-finished	115010000	60	m	
	standard colours	1150100..	60	m	
	RAL	115010099	60	m	
	Support profile 20 mm				
	mill-finished	115020000	60	m	
	standard colours	1150200..	60	m	
	RAL	115020099	60	m	
	Support profile 40 mm				
	mill-finished	115040000	60	m	
	standard colours	1150400..	60	m	
	RAL	115040099	60	m	

	Product description	article no.	p.u. m	Unit	price €
	basic channel A 17-GS length 5,20 m				
	mill-finished	810001000	5,2	m	
	standard colours	8100010..	5,2	m	
	silver anodized EV 1	810001041	5,2	m	
	bronze anodized BC 4 .. 51, C 33 .. 55	8100010..	5,2	m	
	RAL	810001099	5,2	m	
	guide channel A 17 length 5,20 m				
	mill-finished	810002000	5,2	m	
	standard colours	8100020..	5,2	m	
	silver anodized EV 1	810002041	5,2	m	
	bronze anodized BC 4 .. 51, C 33 .. 55	8100020..	5,2	m	
	RAL	810002099	5,2	m	
	cover for A 17-GS				
	mill-finished	810003000	6	m	
	standard colours	8100030..	6	m	
	silver anodized EV 1	810003041	6	m	
	bronze anodized BC 4 .. 51, C 33 .. 55	8100030..	6	m	
	RAL	810003099	6	m	
	edge protection 21 x 10				
	mill-finished	810003200	6	m	
	silver anodized EV 1	810003241	6	m	
	glas seal insert				
	TPE black	810080002	100	m	
	glas seal self-adhesive (double barrelled)				
	EPDM black	810080003	100	m	
	glas support				
	black	810080001	1	pair	



	Product description	article no.	p.u. m	Unit	price €
	PVC insert (double barrelled)				
	Standard version for mini curtain M 317, M 328-N, KM 317	119010000	360	m	
	T-shaped insert				
	Special version for single wall curtain A9	119120300	400	m	
	Polyethylene insert (double barrelled)				
	thin for roller curtain MY 442 / MY 448	119060000	300	m	
	Polyethylene insert for profile M 521				
	applicable for M 521, M 528 and KM 521	119120100	1000	m	
	Brush inserts				
	thin A = 4,25 mm / B = 3,25 mm	119030090	475	m	
	thick brush A = 6,25 mm / B = 5,25 mm	119040090	275	m	
	Solid brush				
		119050090	450	m	
	Extra charge for brushes and inserts in small quantities				
	Extra charge for brushes and inserts in small quantities (per piece)	890000200		pce	

Please note our "Recommended use of PVC and brush inserts". Please refer to our "technical overview" at the end of the catalogue.

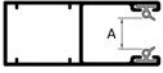
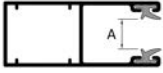

EXTRA CHARGES FOR GUIDE CHANNELS

WITH THREADED PVC- AND BRUSH INSERTS



ALUKON

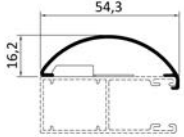

	Product description	article no.	p.u. m	Unit	price €
	PVC inserts				
	2 x PVC insert A = 9,6 mm				
	Extra charge standard insert	..9911000		m	
	Extra charge standard insert (DF)	129911000		m	
	Polyethylen insert				
	2 x thin insert A = 10,4 mm				
	2 x insert for M 521 A = 14,0 mm				
	Extra charge Polyethylen insert	..9910400		m	
	Extra charge insert M 521	..9910900		m	
	Extra charge insert Polyethylene (DF)	129910400		m	
	T-insert				
	2 x T-insert A = 7,2 mm				
	2 x s_onro [®] -insert A = 8,8 - 9,3 mm				
	Extra charge T-insert	..9911500		m	
	Extra charge s_onro insert	..9911400		m	
	Extra charge T-shaped insert (DF)	129911500		m	
	Brush inserts				
	2 x thick brush A = 7,5 mm				
	2 x solid brush A = 5,5 mm				
	1 x solid brush, 1 x thick brush A = 6,5 mm				
	Extra charge thick brush	..9912100		m	
	Extra charge solid brush	..9910200		m	
	Extra charge solid brush + thick brush	..9910300		m	
	Extra charge protection film single-sided	..9910700		m	
	Extra charge protection film double-sided	..9910800		m	
	Extra charge thick brush (DF)	129912100		m	
	Extra charge solid brush (DF)	129910200		m	
	Extra charge solid brush and thick brush (DF)	129910300		m	
Extra charge protection film single-sided (DF)	129910700		m		
Extra charge protection film two-sided (DF)	129910800		m		





Please note our "Recommended use of PVC and brush inserts".







	Product description	article no.	p.u. m	Unit	price €
	Guide channel cover FAR-BC A 3				
	mill-finished	100800000	36	m	
	standard colours	1008000..	36	m	
	21 brown SF	26 white 9016 mat			
	silver anodized EV 1	100800041	36	m	
	bronze anodized BC 4 ..51, C 33 ..55	1008000..	36	m	
	RAL	100800099	36	m	
	Mounting clip for FAR-BC				
	for mounting on 53 mm guide channels	109000100	20	pce	
	Space holder set, 240mm				
	mill-finished	100830000	50	pce	
	standard colours	1008300..	20	pce	
	26 white 9016 mat				
	bronze coated BC 4 ..09, C 33 ..25	1008300..	20	pce	
	RAL	100830099	1	pce	

Please note: There is no stock service in bronze anodized BC 4 and C 33. A certain delivery time should be accepted.

	Product description	article no.	p.u. m	Unit	price €
	Inlay for all 53 mm guide channels				
	V2A stainless steel	119270100	100	pce	
	for standard guide channels				
	A 3, A 4, A 8-12, A 8-20, A 12 galvanized	119250100	10	pce	
	A 3, A 4, A 8-12, A 8-20, A 12 standard colours	1192501..	10	pce	
	09 bronze coated 25 bronze C33 coated				
	A 3, A 4, A 8-12, A 8-20, A 12 RAL	119250199	10	pce	
	for standard guide channels				
	A 5, A 6, A 5-12 galvanized	119250200	10	pce	
	A 5, A 6, A 5-12 standard colours	1192502..	10	pce	
	09 bronze coated 26 white 9016 mat	25 bronze C33 coated			
	A 5, A 6, A 5-12 RAL	119250299	10	pce	
	for standard guide channels				
	A 13, A 14 galvanized	119250300	10	pce	
	A 13, A 14 standard colours	1192503..	10	pce	
	09 bronze coated 25 bronze C33 coated				
A 13, A 14 RAL	119250399	10	pce		
	for guide channel A 15				
	A 15 left galvanized	119250400	10	pce	
	A 15 left standard colours	1192504..	10	pce	
	09 bronze coated 25 bronze C33 coated				
	A 15 left RAL	119250499	10	pce	
	A 15 right galvanized	119250500	10	pce	
	A 15 right standard colours	1192505..	10	pce	
	09 bronze coated 25 bronze C33 coated				
A 15 right RAL	119250599	10	pce		

	Product description	article no.	p.u. m	Unit	price €	
	for guide channels with FAR-BC/ES					
	FAR with A 3, A 4, A 8, A 12, A 3 left mill-finished	119251100	10	pce		
	FAR with A 3, A 4, A 8, A 12, A 3 left standard colours	1192511..	10	pce		
	08 silver 09 bronze coated	25 bronze C33 coated 26 white 9016 mat				
	FAR with A 3, A 4, A 8, A 12, A 3 left RAL	119251199	10	pce		
	FAR with A 3, A 4, A 8, A 12, A 3 right mill-finished	119251200	10	pce		
	FAR with A 3, A 4, A 8, A 12, A 3 right standard colours	1192512..	10	pce		
	08 silver 09 bronze coated	25 bronze C33 coated 26 white 9016 mat				
	FAR with A 3, A 4, A 8, A 12, A 3 right RAL	119251299	10	pce		
		for double guide channels				
DF A 3, DF A 3-12 galvanized		119250800	10	pce		
DF A 3, DF A 3-12 standard colours		1192508..	10	pce		
09 bronze coated 26 white 9016 mat		25 bronze C33 coated				
DF A 3, DF A 3-12 RAL		119250899	10	pce		
for double guide channels						
DF A 5 galvanized		119250900	10	pce		
DF A 5 standard colours		1192509..	10	pce		
09 bronze coated 26 white 9016 mat		25 bronze C33 coated				
DF A 5 RAL		119250999	10	pce		

	Product description	article no.	p.u. m	Unit	price €
	for A 3, A 4, A 8-12, A 12				
	A 3, A 4, A 8-12, A 8-20, A 12 white	119200100	100	pce	
	A 3, A 4, A 8-12, A 8-20, A 12 black	119200200	100	pce	
	for A 13, A 14				
	A 13, A 14 white	119201100	100	pce	
	A 13, A 14 black	119201200	100	pce	
	for A 15				
	A 15 white	119202100	50	pair	
	A 15 black	119202200	50	pair	
	for DF A 3, DF A 3-12				
	DF A 3, DF A 3-12 white	119203100	100	pce	
	DF A 3, DF A 3-12 black	119203200	100	pce	
	Raised head self tapping screws A 2 2,2 x 6,5 mm	891192700	2000	pce	

	Product description	article no.	p.u. m	Unit	price €
	plastic cover cap flat 10 mm (price per 100 pc.)				
	standard colours	89105..00	1000	pce	
	01 white 9016 07 cream white 9001 02 brown SF 09 natural 9006 03 grey 7038 13 charcoal 7016 05 nougat brown				
	plastic cover cap flat 10 mm 10 pieces connected in a ring (price per 1 pc.)				
	black, for coating	891059000	50	pce	
	RAL	891059099	50	pce	
	PVC decoration cover, Ø 12 mm x 2,5 mm drill-hole Ø 5 mm (for screws with corresponding hole)				
	standard colours	89102..00	1000	pce	
	01 white 05 nougat brown 02 brown SF 06 beige 03 grey				
	Counter sunk bolt, galvanized for step drilling on guide channels up to 22mm depth				
	4,5 x 30 mm	891190900	1000	pce	
	Counter sunk bolt, galvanized for step drilling on guide channels up to 22mm depth, for space guide channels A 8-12, A 8-20, A 5-12 and A 15 as well as guide channel for insect repelling-system A 20				
	4,5 x 50 mm	891190100	500	pce	
	countersunk galvanized , 4,5 x 70 mm (price per 100 pieces)	891191200	200	pce	
	Drill for step drilling HSS, 10,2 mm x 5,0 mm				
	for 10 mm cover caps	891510101	1	pce	

	Product description	article no.	p.u. m	Unit	price €
	Aluminium-tilt hinge (including hinges)				
	mill-finished	210100000	1	pair	
	white	210100001	1	pair	
	RAL	210100099	1	pair	

6 FÜHRUNGSSCHIENEN FÜR DEN NEUBAUBEREICH, KEDEREINLAGEN

Coulisses traditionelles, joints

Guide channels for new buildings, inserts

Vodící lišty pro oblast novostaveb, těsnící vložky

Prowadnice do nowego budownictwa, uszczelki

Nieuwbouwgeleiders, rubber/borstel inlages

Vezetősínek a maxi redőnyökhöz, gumi és kefe betétek

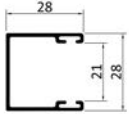
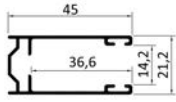
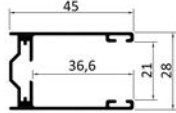
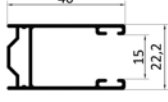
	Product description	article no.	p.u. m	Unit	price €
	Guide channel NB 28, without insert				
	mill-finished	130280000	72	m	
	standard colours	1302800..	72	m	
	21 brown SF	26 white 9016 mat			
	silver anodized EV 1	130280041	72	m	
	bronze anodized BC 4 ..51, C 33 ..55	1302800..	72	m	
	RAL	130280099	72	m	
	Guide channel NB-N 21, without insert				
	mill-finished	130210000	72	m	
	standard colours	1302100..	72	m	
	08 silver	26 white 9016 mat			
	21 brown SF	82 charcoal			
	silver anodized EV 1	130210041	72	m	
	RAL	130210099	72	m	
	Guide channel NB-N 28, without insert				
	mill-finished	130290000	36	m	
	standard colours	1302900..	36	m	
	21 brown SF	26 white 9016 mat			
	silver anodized EV 1	130290041	36	m	
	RAL	130290099	36	m	
		guide raik NB-N 22, without insert			
mil finished		130220000	36	m	
standard colours		1302200..	36	m	
08 silver		26 white 9016 matt			
82 anthracite grey					
silver anodized EV 1		130220041	36	m	
RAL		130220099	36	m	

Please note: There is no stock service in bronze anodized BC 4 and C 33. A certain delivery time should be accepted.

EXTRUDED GUIDE CHANNELS FOR NEW BUILDINGS

WITH SOLID PVC INSERT

ALUKON

	Product description	article no.	p.u. m	Unit	price €
	Guide channel NB 30, with insert				
	mill-finished (without insert)	130300000	36	m	
	standard colours	1303000..	36	m	
	26 white 9016 mat				
	silver anodized EV 1	130300041	36	m	
	bronze anodized BC 4	130300051	36	m	
	RAL	130300099	36	m	
	Guide channel NB 40, with insert				
	mill-finished (without insert)	130400000	36	m	
	standard colours	1304000..	36	m	
	26 white 9016 mat				
	silver anodized EV 1	130400041	36	m	
	bronze anodized BC 4	130400051	36	m	
	RAL	130400099	36	m	

Please note: There is no stock service in bronze anodized BC 4 and C 33. A certain delivery time should be accepted.

PVC- AND BRUSH INSERTS FOR NEW BUILDING GUIDE CHANNELS



ALUKON

	Product description	article no.	p.u. m	Unit	price €
	Solid PVC insert for new buildings				
	only for NB 30 and NB 40	139010000	300	m	
	PVC insert (double barralled)				
	Standard version for mini curtain M 317, M 328-N, KM 317	119010000	360	m	
	Polyethylene insert (double barralled)				
	thin for roller curtain MY 442 / MY 448	119060000	300	m	
	Polyethylene insert for profile M 521				
	applicable for M 521, M 528 and KM 521	119120100	1000	m	
	Brush inserts				
	thin A = 4,25 mm / B = 3,25 mm	119030090	475	m	
	thick brush A = 6,25 mm / B = 5,25 mm	119040090	275	m	
	Solid brush				
		119050090	450	m	
	Extra charge for brushes and inserts in small quantities				
	Extra charge for brushes and inserts in small quantities (per piece)	890000200		pce	

Please note our "Recommended use of PVC and brush inserts". Please refer to our "technical overview" at the end of the catalogue.

EXTRA CHARGES FOR GUIDE CHANNELS FOR NEW BUILDINGS

WITH THREADED PVC- AND BRUSH INSERTS

	Product description	article no.	p.u. m	Unit	price €
	PVC inserts				
	2 x PVC insert	A = 8,8 mm (NB-N 21) / A = 15,6 (NB-N 28, NB 28)			
	PVC insert	139911000		m	
	Polyethylen insert				
	2 x thin insert	A = 9,6 mm (NB-N 21) / A = 16,4 mm (NB-N 28, NB 28)			
	2 x insert for M 521	A = 13,2 mm (NB-N 21)			
	Polyethylene insert	139910400		m	
	Insert for M 521	139910900		m	
	Brush inserts				
	2 x thick brush	A = 6,7 mm (NB-N 21) / A = 13,5 (NB-N 28, NB 28)			
	2 x thin brush	A = 10,7 mm (NB-N 21) / A = 17,5 (NB-N 28, NB 28)			
	2 x filling brush	A = 1,2 mm (NB-N 21) / A = 8,0 (NB-N 28, NB 28)			
	2 x solid brush	A = 4,7 mm (NB-N 21) / A = 11,5 (NB-N 28, NB 28)			
	brush insert	139910100		m	
	solid brush	139910200		m	
	thick brush	139912100		m	
solid brush and thick brush	139910300		m		
single-sided protection film	139910700		m		
double-sided protection film	139910800		m		

Please note our "Recommended use of PVC and brush inserts".

	Product description	article no.	p.u. m	Unit	price €
	Guide rail A80, without insert				
	mill-finished	130800000	6	m	
	standard colours	1308000..	6	m	
	RAL	130800099	6	m	
	A81 adapter piece				
	mill-finished	130802000	6	m	
	standard colours	1308020..	6	m	
	RAL	130802099	6	m	
	Unwinding strip aluminium 40mm, length 650 cm				
	mill-finished	761025000	6,5	m	
	standard colours	7610250..	6,5	m	
	RAL	761025099	6,5	m	
	Plug-in nipple socket for A 81 adapter, incl. countersunk head screw 3.5x20				
	galvanized	891193910	100	pce	
	guide terminal for A80				
	black	139061090	25	pair	
	guide rail conclusion inlay for A 80				
	aluminium, mill finished	139060000	100	pce	
	insert 4,1 mm (double-running), black				
	suitable for A80 with M521/KM 521	119110100	400	m	
	Surcharges A80				
	insert 4,1 mm drawn in	139913700		m	
	single-sided protection film	139910700		m	
	double-sided protection film	139910800		m	

All dimensions are average values. Slight deviations due to tolerances are possible.

7 ROLLADENPROFILE

FÜR DEN MINI-, MAXI- UND NEUBAUBEREICH, ARRETIERCLIPSE

Lames des volets roulants pour le domaine mini, maxi et pour le neuf

Roller shutter profiles for the mini, maxi and new building sector, locking clips

Rol. lamely pro oblast „Mini“, „Maxi“ a novostaveb, aretační klipsy

Profile roletowe mini i maxi do nowego budownictwa, aretki

Rolluikprofielen voor mini, maxi (voorzetrolluiken) en nieuwbouw, arre-
teerclips

Redőnylécek a mini és maxi redőnyökhöz, arriterek

FOAMED ALUMINIUM ROLLER SHUTTER PROFILE M 317 (MINI)

ALUKON

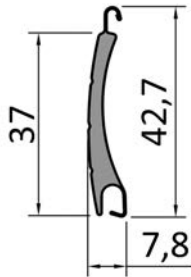

Technical data

Profile height	mm	42,70
Profile thickness	mm	7,60
Profile cover height	mm	37,00
Material thickness	mm	0,30
Weight	kg/m ²	2,80
Max width*	cm	290,00
Max area*	m ²	6,50
Length	cm	600,00
Packing unit	m	360,00

*Benchmark, definition corresponding to wind load table, according to EN 13659

Winding table (without insect repelling system)

box size	max height of element with 40 mm octagonal shaft in cm	max height of element with 60 mm octagonal shaft in cm
100	64	---
125	130	102
138	160	136
150	212	193
165	275	253
180	342	316
205	449	400

Bale diameter

height of curtain in cm	with 40 mm octagonal shaft in cm	with 60 mm octagonal shaft in cm
100	12,20	12,60
120	12,30	13,80
140	13,30	14,50
160	14,10	15,00
180	14,70	15,20
200	15,00	16,30
225	15,90	16,70
250	16,50	16,70
275	17,40	17,80
300	17,50	18,50
325	18,50	19,10
350	18,70	19,60

List of articles including prices in €/m

Part number without light slits	Part number with light slits	Colour description	Price
153170101	153170201	white	
153170102	153170202	grey	
153170103	153170203	velvet brown	
153170104	153170204	light beige	
153170105	153170205	dark beige	
153170107	153170207	natural	
143170109	143170209	bronze	
153170111	153170211	oak	
153170112	153170212	teak	
143170113	143170213	moss green	
143170114	143170214	purple red	
143170118	143170218	DB 703	
153170122	153170222	golden oak	

Part number without light slits	Part number with light slits	Colour description	Price
153170123	153170223	light grey	
153170127	153170227	cream white	
143170137	143170237	velvet grey	
153170138	153170238	charcoal	
153170143	153170243	quartz grey	
153170144	153170244	basalt grey	
153170145	153170245	concrete grey	
153170146	153170246	black grey	
153170162	153170262	santiago grey	
153170184	153170284	light ivory	
153170185	153170285	grey aluminium 9007	
153170190	153170290	black	

FOAMED ALUMINIUM ROLLER SHUTTER PROFILE M 328-N (MINI)

ALUKON

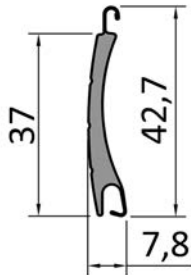

Technical data

Profile height	mm	42,70
Profile thickness	mm	7,80
Profile cover height	mm	37,00
Material thickness	mm	0,28
Weight	kg/m ²	2,60
Max width*	cm	270,00
Max area*	m ²	5,80
Length	cm	600,00
Packing unit	m	360,00

*Benchmark, definition corresponding to wind load table, according to EN 13659

Winding table (without insect repelling system)

box size	max height of element with 40 mm octagonal shaft in cm	max height of element with 60 mm octagonal shaft in cm
100	64	---
125	130	102
138	160	136
150	212	193
165	275	253
180	342	316
205	449	400

Bale diameter

height of curtain in cm	with 40 mm octagonal shaft in cm	with 60 mm octagonal shaft in cm
100	11,30	12,90
120	12,30	12,90
140	13,30	13,70
160	13,50	13,90
180	14,30	14,50
200	14,70	15,10
225	15,70	15,90
250	16,10	17,30
275	17,30	17,30
300	17,70	18,70
325	18,50	18,90
350	18,90	19,90

List of articles including prices in €/m

Part number without light slits	Part number with light slits	Colour description	Price
153290101	153290201	white	
153290102	153290202	grey	
153290103	153290203	velvet brown	
153290104	153290204	light beige	
153290107	153290207	natural	
153290113	153290213	moss green	
153290127	153290227	cream white	
153290130	153290230	jamaican brown	
153290135	153290235	Sand beige	
153290138	153290238	charcoal	
153290184	153290284	light ivory	
153290122	153290222	golden oak	
153290186	153290286	walnut	

FOAMED ALUMINIUM ROLLER SHUTTER PROFILE MY 442 (MINI)

ALUKON

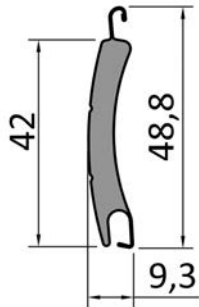

Technical data

Profile height	mm	48,80
Profile thickness	mm	9,30
Profile cover height	mm	42,00
Material thickness	mm	0,30
Weight	kg/m ²	2,85
Max width*	cm	400,00
Max area*	m ²	8,50
Length	cm	600,00
Packing unit	m	216,00

*Benchmark, definition corresponding to wind load table, according to EN 13659

Winding table (without insect repelling system)

box size	max height of element with 40 mm octagonal shaft in cm	max height of element with 60 mm octagonal shaft in cm
100	---	---
125	---	76
138	---	105
150	---	134
165	---	190
180	---	236
205	---	296

Bale diameter

height of curtain in cm	with 40 mm octagonal shaft in cm	with 60 mm octagonal shaft in cm
100	---	13,20
120	---	13,80
140	---	14,60
160	---	16,00
180	---	16,00
200	---	17,20
225	---	17,20
250	---	18,80
275	---	18,80
300	---	20,20

List of articles including prices in €/m

Part number without light slits	Part number with light slits	Colour description	Price
154430101	154430201	white	
154430102	154430202	grey	
154430103	154430203	velvet brown	
154430104	154430204	light beige	
154430107	154430207	natural	
154430110	154430210	white 9016	
154430112	154430212	teak	
154430118	154430218	DB 703	
154430122	154430222	golden oak	
154430123	154430223	light grey	
154430127	154430227	cream white	
154430128	154430228	fir green	

Part number without light slits	Part number with light slits	Colour description	Price
154430130	154430230	jamaican brown	
154430138	154430238	charcoal	
154430139	154430239	steel blue	
154430143	154430243	quartz grey	
154430144	154430244	basalt grey	
154430146	154430246	black grey	
154430184	154430284	light ivory	
154430185	154430285	grey Aluminium	
154430186	154430286	walnut	
154430190	154430290	black	
154430195	154430295	black metallic	

FOAMED ALUMINIUM ROLLER SHUTTER PROFILE MY 448 (MINI)

ALUKON

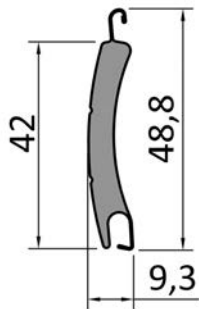

Technical data

Profile height	mm	48,80
Profile thickness	mm	9,30
Profile cover height	mm	42,00
Material thickness	mm	0,28
Weight	kg/m ²	2,65
Max width*	cm	300,00
Max area*	m ²	7,80
Length	cm	600,00
Packing unit	m	216,00

*Benchmark, definition corresponding to wind load table, according to EN 13659

Winding table (without insect repelling system)

box size	max height of element with 40 mm octagonal shaft in cm	max height of element with 60 mm octagonal shaft in cm
100	---	
125	---	76
138	---	105
150	---	134
165	---	190
180	---	236
205	---	296

Bale diameter

height of curtain in cm	with 40 mm octagonal shaft in cm	with 60 mm octagonal shaft in cm
100	---	13,20
120	---	13,80
140	---	14,60
160	---	16,00
180	---	16,00
200	---	17,20
225	---	17,20
250	---	18,80
275	---	18,80
300	---	20,20

List of articles including prices in €/m

Part number without light slits	Part number with light slits	Colour description	Price
154480101	154480201	white	
154480102	154480202	grey	
154480103	154480203	velvet brown	
154480104	154480204	light beige	
154480107	154480207	natural	
154480127	154480227	cream white	
154480138	154480238	charcoal	
154480122	154480222	golden oak	
154480130	154480230	jamaican brown	
154480143	154480243	quartz grey	

FOAMED ALUMINIUM ROLLER SHUTTER PROFILE M 521 (MAXI)

ALUKON

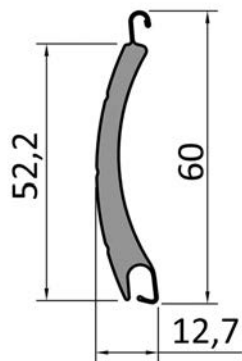

Technical data

Profile height	mm	60,00
Profile thickness	mm	12,70
Profile cover height	mm	52,20
Material thickness	mm	0,36
Weight	kg/m ²	3,10
Max width*	cm	380,00
Max area*	m ²	8,00
Length	cm	600,00
Packing unit	m	192,00

*Benchmark, definition corresponding to wind load table, according to EN 13659

Winding table (without insect repelling system)

box size	max height of element with 60 mm octagonal shaft in cm
138	90
150	125
165	150
180	220
205	280
230	390
254	460

Bale diameter

height of curtain in cm	with 60 mm octagonal shaft in cm
100	13,80
120	14,80
140	14,80
160	16,20
180	16,80
200	17,70
225	18,40
250	19,60
275	19,80
300	21,20
325	21,80
350	22,50
375	23,00
400	23,20

List of articles including prices in €/m

Part number without light slits	Part number with light slits	Colour description	Price
275210101	275210201	white	
275210102	275210202	grey	
275210103	275210203	velvet brown	
275210104	275210204	light beige	
275210107	275210207	natural	
275210123	275210223	light grey	
275210130	275210230	jamaican brown	
275210138	275210238	charcoal	
275210143	275210243	quartz grey	
275210162	275210262	santiago grey	
275210184	275210284	light ivory	
275210185	275210285	grey Aluminium	
275210190	275210290	black	

275210113	275210213	moss green	
-----------	-----------	------------	--

FOAMED ALUMINIUM ROLLER SHUTTER PROFILE M 551 (MAXI)

ALUKON

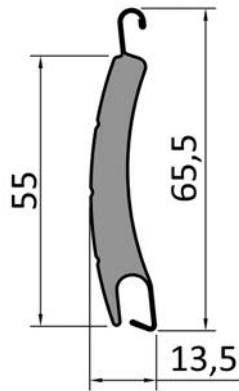

Technical data

Profile height	mm	65,50
Profile thickness	mm	13,50
Profile cover height	mm	55,00
Material thickness	mm	0,43
Weight	kg/m ²	5,00
Max width*	cm	530,00
Max area*	m ²	13,00
Length	cm	600,00
Packing unit	m	144,00

*Benchmark, definition corresponding to wind load table, according to EN 13659

Bale diameter

height of curtain in cm	with 60/70 mm octagonal shaft and slide over ring 80 in cm
100	17,50
120	17,50
140	20,00
160	20,00
180	20,00
200	22,00
225	22,00
250	24,50
275	24,50
300	24,50
325	24,50
350	24,50
375	26,00
400	26,00

List of articles including prices in €/m

Part number without light slits	Part number with light slits	Colour description	Price
275510101	275510201	white	
275510102	275510202	grey	
275510103	275510203	velvet brown	
275510104	275510204	light beige	
275510107	275510207	natural	
275510112	275510212	teak	
275510122	275510222	golden oak	
275510127	275510227	cream white	
275510130	275510230	jamaican brown	
275510138	275510238	charcoal	
275510190	275510290	black	

FOAMED ALUMINIUM ROLLER SHUTTER PROFILE M 558 (MAXI)

ALUKON

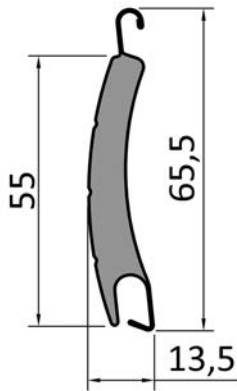

Technical data

Profile height	mm	65,50
Profile thickness	mm	13,50
Profile cover height	mm	55,00
Material thickness	mm	0,36
Weight	kg/m ²	4,30
Max width*	cm	430,00
Max area*	m ²	9,00
Length	cm	600,00
Packing unit	m	144,00

*Benchmark, definition corresponding to wind load table, according to EN 13659

Winding table (without insect repelling system)

box size	max height of element with 60 mm octagonal shaft in cm	max height of element with 60/70 mm octagonal shaft and slide over ring 80 in cm
150	---	60
165	---	99
180	---	137
205	---	187
230	---	247
254	---	319

Bale diameter

height of curtain in cm	with 60 mm octagonal shaft in cm	with 60/70 mm octagonal shaft and slide over ring 80 in cm
100	---	17,50
120	---	17,50
140	---	20,00
160	---	20,00
180	---	20,00
200	---	22,00
225	---	22,00
250	---	24,50
275	---	24,50
300	---	24,50

List of articles including prices in €/m

Part number without light slits	Part number with light slits	Colour description	Price
275580101	275580201	white	
275580102	275580202	grey	
275580103	275580203	velvet brown	
275580104	275580204	light beige	
275580107	275580207	natural	
275580130	275580230	jamaican brown	
275580138	275580238	charcoal	
275580162	275580262	santiago grey	

SINGLE WALL ALUMINIUM ROLLER SHUTTER PROFILE A 9 (MINI)

ALUKON

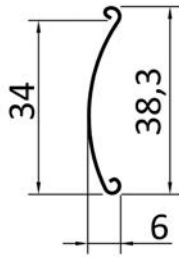

Technical data

Profile height	mm	38,30
Profile thickness	mm	6,00
Profile cover height	mm	34,00
Material thickness	mm	0,40
Weight	kg/m ²	1,65
Max width*	cm	200,00
Max area*	m ²	3,50
Length	cm	600,00
Packing unit	m	120,00

*Benchmark, definition corresponding to wind load table, according to EN 13659

Winding table (without insect repelling system)

box size	max height of element with 40 mm octagonal shaft in cm	max height of element with 60 mm octagonal shaft in cm
100	172	---
125	327	269
138	358	324

List of articles including prices in €/m

Part number without light slits	Colour description	Price
170091001	white	
170091002	grey	
170091004	light beige	
170091007	natural	
170091010	pastel grey	
170091038	charcoal	

The roller shutter profile A9 can only be ordered with a longer delivery time and from a minimum order quantity of 480 metres per colour.

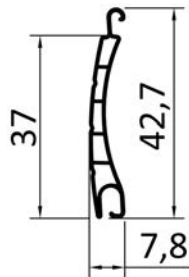

Technical data

Profile height	mm	43,00
Profile thickness	mm	7,80
Profile cover height	mm	36,60
Material thickness	mm	0,70
Weight	kg/m ²	3,00
Max width*	cm	200,00
Max area*	m ²	3,00
Length	cm	600,00
Packing unit	m	240,00

*Benchmark, definition corresponding to wind load table, according to EN 13659

**Winding table
(without insect repelling system)**

box size	max height of element with 40 mm octagonal shaft in cm	max height of element with 60 mm octagonal shaft in cm
100	64	---
125	130	102
138	160	136
150	212	193
165	275	253
180	342	316
205	---	400

Bale diameter

height of curtain in cm	with 40 mm octagonal shaft in cm	with 60 mm octagonal shaft in cm
100	12,20	12,60
120	12,30	13,80
140	13,30	14,50
160	14,10	15,00
180	14,70	15,20
200	15,00	16,30
225	15,90	16,70
250	16,50	16,70
275	17,40	17,80
300	17,50	18,50
325	18,50	19,10
350	18,70	19,60

List of articles including prices in €/m

Part number without light slits	Part number with light slits	Colour description	Price
183170101	183170201	white	
183170102	183170202	grey	
183170104	183170204	light beige	
183170111	183170211	clear wood	
183170162	183170262	santiago grey	
183170184	183170284	light ivory	

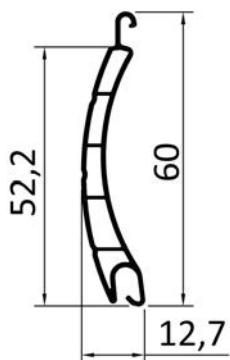

Technical data

Profile height	mm	60,00
Profile thickness	mm	12,70
Profile cover height	mm	52,20
Material thickness	mm	0,80
Weight	kg/m ²	3,60
Max width*	cm	280,00
Max area*	m ²	4,60
Length	cm	600,00
Packing unit	m	192,00

*Benchmark, definition corresponding to wind load table, according to EN 13659

**Winding table
(without insect repelling system)**

box size	max height of element with 40 mm octagonal shaft in cm	max height of element with 60 mm octagonal shaft in cm
100	---	---
125	---	---
138	---	90
150	---	125
165	---	150
180	---	220
205	---	280

Bale diameter

height of curtain in cm	with 40 mm octagonal shaft in cm	with 60 mm octagonal shaft in cm
100	---	13,80
120	---	14,80
140	---	14,80
160	---	16,20
180	---	16,80
200	---	17,70
225	---	18,40
250	---	19,60
275	---	19,80
300	---	21,20
325	---	21,80
350	---	22,50
375	---	23,00
400	---	23,20

List of articles including prices in €/m

Part number without light slits	Part number with light slits	Colour description	Price
185210101	185210201	white	
185210102	185210202	grey	
185210104	185210204	light beige	
185210111	185210211	clear wood	
185210162	185210262	santiago grey	
185210184	185210284	light ivory	

EXTRUDED DOUBLE WALL ALUMINIUM ROLLER SHUTTER PROFILE V 37 (MINI) (WITH STRUCTURED COATING)

ALUKON

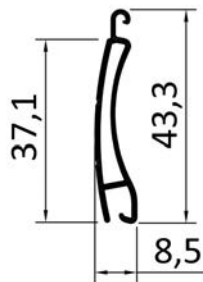

Technical data

Profile height	mm	43,30
Profile thickness	mm	8,50
Profile cover height	mm	37,10
Material thickness	mm	1,00
Weight	kg/m ²	7,00
Max width*	cm	350,00
Max area*	m ²	8,50
Length	cm	580,00
Packing unit	m	58,00

*Benchmark, definition corresponding to wind load table, according to EN 13659

Winding table (without insect repelling system)

box size	max height of element with 40 mm octagonal shaft in cm	max height of element with 60 mm octagonal shaft
125	89	78
138	122	108
150	159	145
165	200	185
180	245	234
205	330	330

Bale diameter

height of curtain in cm	with 40 mm octagonal shaft in cm	with 60 mm octagonal shaft in cm
100	12,80	13,20
120	13,60	14,60
140	14,40	14,60
160	14,40	16,00
180	15,80	16,00
200	16,20	17,40
225	17,00	17,40
250	17,00	18,80
275	18,40	18,80
300	19,60	20,00
325	19,60	20,00
350	19,60	21,40
375	21,40	21,40
400	21,40	22,20

List of articles including prices in €/m

Part number without light slits	Colour description	Price
802380100	mill-finished	
802380199	30 ALUKON structure colours	

Part number with light slits	Colour description	Price
802380200	mill-finished	
802380299	30 ALUKON structure colours	

For an overview of all 30 structured colours, please refer to "technical overview".

EXTRUDED DOUBLE WALL ALUMINIUM ROLLER SHUTTER PROFILE E 55 (MAXI) (WITH STRUCTURED COATING)

ALUKON

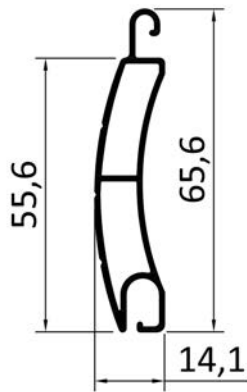

Technical data

Profile height	mm	65,60
Profile thickness	mm	14,10
Profile cover height	mm	55,60
Material thickness	mm	1,00
Weight	kg/m ²	8,50
Max width*	cm	500,00
Max area*	m ²	13,00
Length	cm	580,00
Packing unit	m	58,00

*Benchmark, definition corresponding to wind load table, according to EN 13659

Bale diameter

height of curtain in cm	with 60 mm octagonal shaft in cm	with 60/70 mm octagonal shaft and slide over ring 80 in cm
100	17,00	---
120	17,60	---
140	17,60	---
160	19,60	---
180	20,00	---
200	22,00	20,60
225	22,00	22,00
250	22,20	22,80
275	24,20	22,80
300	24,20	25,00
325	26,20	25,00
350	26,60	26,20
375	26,60	27,40
400	28,80	27,40

List of articles including prices in €/m

Part number without light slits	Colour description	Price
802550100	mill-finished	
802550199	30 ALUKON structure colours	

Part number with light slits	Colour description	Price
802550200	mill-finished	
802550299	30 ALUKON structure colours	

For an overview of all 30 structured colours, please refer to "technical overview".

FOAMED ALUMINIUM ROLLER SHUTTER PROFILE MY 442-H WITH HARD FOAM (MINI)

ALUKON

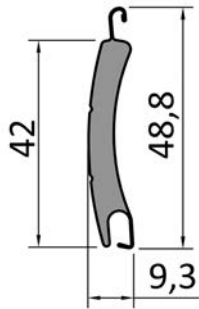

Technical data

Profile height	mm	48,80
Profile thickness	mm	9,30
Profile cover height	mm	42,00
Material thickness	mm	0,30
Weight	kg/m ²	4,32
Max width*	cm	400,00
Max area*	m ²	8,50
Length	cm	600,00
Packing unit	m	216,00

*Benchmark, definition corresponding to wind load table, according to EN 13659

Winding table (without insect repelling system)

box size	max height of element with 40 mm octagonal shaft in cm	max height of element with 60 mm octagonal shaft in cm
100	---	---
125	---	76
138	---	105
150	---	134
165	---	190
180	---	236
205	---	296





Bale diameter

height of curtain in cm	with 40 mm octagonal shaft in cm	with 60 mm octagonal shaft in cm
100	---	13,20
120	---	13,80
140	---	14,60
160	---	16,00
180	---	16,00
200	---	17,20
225	---	17,20
250	---	18,80
275	---	18,80
300	---	20,20

List of articles including prices in €/m

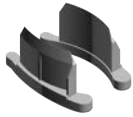

Part number without light slits	Part number with light slits	Colour description	Price
804430101	804430201	white	
804430102	804430202	grey	
804430103	804430203	velvet brown	
804430104	804430204	light beige	
804430107	804430207	natural	
804430127	804430227	cream white	
804430184	804430284	light ivory	

This product is also available on request in all colours of profil MY 442 (refer to page 7.3; minimum order quantity: 2808 m)

	Product description	article no.	p.u. m	Unit	price €
	Locking clips A 317 for M 317 and M 328-N to clamp for both sides (Price per 100 pce)	159370300	1000	pce	
	Locking clips A 442 for MY 442 and MY 448 to clamp for both sides (Price per 100 pce)	159410000	500	pce	
	Locking clips for M 317/ M 328 to punch for V 37 to paste in (punch tool please refer to p. 7.18)				
	left + right (Price per 100 pair)	159370900	500	pair	
	Locking clips PA 442 for MY 442 and MY 448 for embossing (punch tool please refer to p. 7.19)				
	for both sides (Price per 100 pce)	159410200	1000	pce	

POLYAMIDE LOCKING CLIPS FOR NEW BUILDING PROFILES

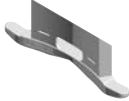
ALUKON

	Product description	article no.	p.u. m	Unit	price €
	Locking clips A 521 for M 521 / M 528 for to punch + clamp (punch tool please refer to page 7.19)				
	for both sides (price per 100 pieces)	279521100	500	pce	
	Locking clips M 551 / M 558				
	for both sides (price per 100 pieces)	279550400	250	pce	
	Locking clamps (price per 1000 pieces)				
	4 mm (N3 / 4SS); for M 317, M 328-N, MY 442, MY 448	891410200	25000	pce	
	6 mm (N3 / 6SS); for M 551, M 521, M 558	891410300	16000	pce	

POLYAMIDE LOCKING CLIPS

FOR HARD FOAM PROFILES AND EXTRUDED PROFILES

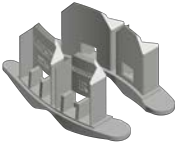
	Product description	article no.	p.u. m	Unit	price €
	Locking clips for MY 442-H (to paste in) for both sides (price per 100 pieces)	809410100	200	pce	
	Locking clips for E 55 (to rivet) left + right (Price per 100 pair)	809550300	100	pair	

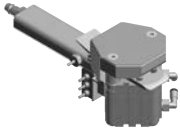
	Product description	article no.	p.u. m	Unit	price €
	Dimensions: 200 x 100 x 160 mm, weight: 1200 g, working pressure: 4 - 7 bar, max operating pressure: 8 bar, air consumption: 0,2 l with 6 bar. Recommended lubricant: pneumatic oil typ HVLP according to DIN 51524				
	for profiles M 317, M 328 in conjunction with locking clip 159370900 for profiles MY 442, MY 448 in conjunction with locking clip 159410200	891410500	1	pce	
	for profile M 521 in conjunction with locking clip 279521100	891410600	1	pce	
	for profile M 551, M 558 in conjunction with locking clip 279550400	891410700	1	pce	

8 ROLLADENFERTIGPANZER FÜR DEN MINI-, MAXI- UND NEUBAUBEREICH

Tabliers finis pour le domaine mini, maxi et pour le neuf

Roller shutter curtains for the mini, maxi and new building sector

Roletové pancíře pro oblast „Mini“, „Maxi“ a novostaveb

Gotowe pancerze mini i do nowego budownictwa

Rolluikpantser op maat voor mini, maxi en nieuwbouw

Készre gyárgott redöny palástok a mini és maxi redönyökhöz

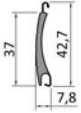
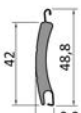
	Product description	article no.	p.u. m	Unit	Price / m ²
	Curtain M 317 (for technical details please refer to section 7)				
	standard colours locked	4031701..	1	pce	
	standard colours unlocked	4031700..	1	pce	
	01 white	23 light grey			
	02 grey	27 cream white			
	03 velvet brown	37 velvet grey			
	04 beige	38 charcoal			
	07 natural	43 quartz grey			
	11 oak	62 santiago grey			
	12 teak	84 light ivory			
	13 moss green	85 grey aluminium			
	18 DB 703	90 black			
	22 golden oak				
	Special colours locked	4031701..	1	pce	
Special colours unlocked	4031700..	1	pce		
05 dark beige	44 basalt grey				
09 bronze	45 concrete grey				
14 purple red	46 black grey				
	Curtain MY 442 (for technical details please refer to section 7)				
	standard colours locked	4044301..	1	pce	
	standard colours unlocked	4044300..	1	pce	
	01 white	23 light grey			
	02 grey	27 cream white			
	03 velvet brown	38 charcoal			
	04 beige	43 quartz grey			
	07 natural	84 light ivory			
	10 white 9016	86 walnut			
	12 teak	90 black			
	18 DB 703	95 black metallic			
	22 golden oak				
	Special colours locked	4044301..	1	pce	
	Special colours unlocked	4044300..	1	pce	
28 fir green	44 basalt grey				
30 jamaican brown	46 black grey				
39 steel blue	85 grey aluminium				

All curtains including spring bolt, standard end slat and buffers of your choice.

Attention : Minimum area for price calculation is 1 m².

FOAMED ALUMINIUM CURTAINS FOR THE NEW BUILDING SECTOR

ALUKON

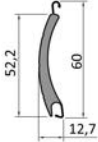
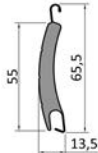
	Product description	article no.	p.u. m	Unit	Price / m ²
	Curtain M 521 (for technical details please refer to section 7)				
	standard colours, locked	4052101..	1	pce	
	standard colours, unlocked	4052100..	1	pce	
	01 white	23 light grey			
	02 grey	27 cream white			
	03 velvet brown	30 jamaican brown			
	04 beige	37 velvet grey			
	07 natural	38 charcoal			
	11 oak	62 santiago grey			
	12 teak	84 light ivory			
	13 moss green	85 grey aluminium 9007			
18 DB 703	90 black				
	Curtain M 551 (for technical details please refer to section 7)				
	standard colours, locked	4055101..	1	pce	
	standard colours, unlocked	4055100..	1	pce	
	01 white	22 golden oak			
	02 grey	27 cream white			
	03 velvet brown	30 jamaican brown			
	04 beige	38 charcoal			
	07 natural	90 black			
	12 teak				
	Curtain M 558 (for technical details please refer to section 7)				
	standard colours, locked	4055801..	1	pce	
standard colours, unlocked	4055800..	1	pce		
01 white	07 natural				
02 grey	30 jamaican brown				
03 velvet brown	38 charcoal				
04 beige	62 santiago grey				

All curtains including spring bolt, standard end slat and buffers of your choice.

Attention : Minimum area for price calculation is 1 m².

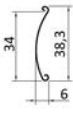
	Product description	article no.	p.u. m	Unit	Price / m ²
	Curtain A 9 (for technical details please refer to section 7)				
	standard colours locked	4100911..	1	pce	
	01 white 02 grey 04 beige	07 natural 10 pastel grey 38 charcoal			

All curtains including spring bolt, standard end slat and buffers of your choice.

Attention : Minimum area for price calculation is 1 m².

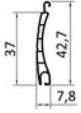
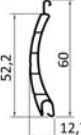
	Product description	article no.	p.u. m	Unit	Price / m ²
	Curtain KM 317 (for technical details please refer to section 7)				
	standard colours, locked	4231701..	1	pce	
	01 white 02 grey 04 beige	11 clear wood 62 santiago grey 84 light ivory			
	surcharge for weighting iron				
		429994100	1	pce	
	Curtain KM 521 (for technical details please refer to section 7)				
	standard colours, locked	4252101..	1	pce	
	01 white 02 grey 04 beige	11 clear wood 62 santiago grey 84 light ivory			
	surcharge for weighting iron				
		429994100	1	pce	

All curtains including spring bolt, standard end slat and buffers of your choice.

Attention : Minimum area for price calculation is 1 m².

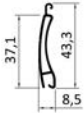
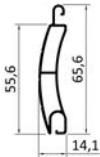
	Product description	article no.	p.u. m	Unit	Price / m ²
	Curtain V 37 (for technical details please refer to section 7)				
	30 ALUKON structure colours locked	822380199	1	pce	
	30 ALUKON structure colours unlocked	822380099	1	pce	
	Curtain E 55 (for technical details please refer to section 7)				
	30 ALUKON structure colours locked	822550199	1	pce	
	30 ALUKON structure colours unlocked	822550099	1	pce	

All curtains including spring bolt, standard end slat and buffers of your choice.

Attention : Minimum area for price calculation is 1 m². Other RAL structure colours are only available with larger order quantity and on request.

	Product description	article no.	p.u. m	Unit	Price / m ²
	Curtain MY 442-H (for technical details please refer to section 7)				
	standard colours locked	8244301..	1	pce	
	standard colours unlocked	8244300..	1	pce	
	01 white	04 beige			
	02 grey	07 natural			
	03 velvet brown	84 light ivory			

All curtains including spring bolt, standard end slat and buffers of your choice.

Attention : Minimum area for price calculation is 1 m².

EXTRA CHARGES FOR CURTAINS

ALUKON

	Product description	article no.	p.u. m	Unit	price €
	Extra charge end slat in special colour	409990300		m	
	surcharge shaft connector	409992900		m	
	Extra charge sliding bolt	409993100		pce	
	Extra charge cylinder lock	409993200		pce	
	Extra charge end slat WSL	409993900		m	
	Extra charge angle end slat SL-ES	409994000		m	
	Surcharge for design end slat	409994400		m	



Technical data

Profile height	mm	17,80
Profile thickness	mm	7,80
Profile cover height	mm	9,90
Weight	kg/m ²	5,80
Max width	cm	200,00
	cm	
Max area	m ²	4,80

Profile for the mini sector - special insert required

Winding table (without insect repelling system)

box size	max height of element with 40 mm octagonal shaft in cm	max height of element with 60 mm octagonal shaft in cm
125	85	-
138	100	70
150	125	105
165	160	135
180	190	165
205	260	250

Bale diameter

height of curtain in cm	with 40 mm octagonal shaft in cm	with 60 mm octagonal shaft in cm
100	12,50	13,80
120	13,60	14,80
140	14,60	15,80
160	15,50	16,70
180	16,40	17,60
200	17,20	18,40
220	18,00	19,20
240	18,80	20,00
260	19,50	20,70
280	20,10	21,40
300	20,50	22,10

List of products including prices in € / m²

standard colours locked	4080101..	
-------------------------	-----------	--

07 silver (9006)
 10 white (9016)
 38 charcoal (7016)
 85 grey aluminium (9007)
 86 DB 703

For areas < 1m² prices are generally calculated on the 1m² pricing basis

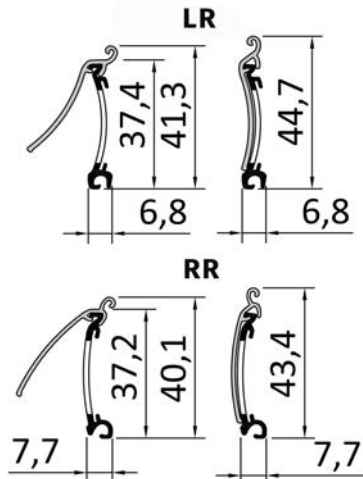

Technical data

Profile height	mm	44,70
Profile thickness	mm	6,80 / 7,70
Profile cover height	mm	40,70
Weight	kg/m ²	7,10
Max width	cm	250,00
Max area	m ²	6,25

Profile for the mini sector.

By placing an order, indication of the guide channel groove depth and distance between the guide channel inlays is mandatory (recommended groove width: 9 - 10 mm). The end slat is only available in the corresponding curtain colour.

LR - leftroller
RR - rightroller

Winding table (without insect repelling system)

box size	max height of element with 40 mm octagonal shaft in cm	max height of element with 60 mm octagonal shaft in cm
100	37	-
125	85	81
138	102	90
150	147	126
165	187	171
180	236	220
205	346	326

Bale diameter

height of curtain in cm	with 40 mm octagonal shaft in cm	with 60 mm octagonal shaft in cm
100	12,70	12,80
120	12,80	14,00
140	13,90	14,90
160	14,40	15,20
180	14,80	15,60
200	15,40	16,30
220	15,60	16,60
240	16,20	17,10
260	16,80	17,80
280	17,40	18,10

List of products including prices in € / m²

standard colours, locked, without insect repellent	4080201..	
standard colours, locked, with insect repellent	4080202..	

01 white
04 beige
07 natural

23 light grey
38 charcoal
85 grey aluminium 9007

For heights < 50 cm prices are generally calculated on the 50 cm pricing basis.

9 SCHLUSSLEISTEN

ANSCHLAGSTOPFEN, ANSCHLAGSTOPPER, ANSCHLAGWINKEL UND ABSCHLUSSPROFILE

Lames finales, butées d'arrêts, angles équerrés, joints finals

Final slats, buffers, stoppers, angle stop, final inserts

Ukončovací lišty, zarážky do ukonč. lišt, narážecí stopky a úhelníky, ukonč. profily

Listwy końcowe, ograniczniki, kątowniki, profile zamykające

Onderlatten, stoothaken, aanslagstoppers, aanslaghoeken, afdichtingen

Zárólécek, rejtett ütközők, külső ütközők, „L“ profil ütközők, záró profi-
lok

END SLATS FOR THE MINI SECTOR

MADE OF EXTRUDED ALUMINIUM

ALUKON

	Product description	article no.	p.u. m	Unit	price €	
	End slat SL KU-N - for covered stop -					
	Standard end slat for all PVC and foamed roller shutter profiles, with groove for PVC and brush inserts suitable PVC connecting buffers: swiveling					
	mill-finished	200150000	60	m		
	standard colours	2001500..	60	m		
	03 nougat brown 28 fir green 08 silver 29 moss green 21 brown SF 82 charcoal 26 white 9016 mat 87 teleg 7947 mat 27 cream white					
	silver anodized EV 1	200150041	60	m		
	bronze anodized BC 4 ..51, C 33 ..55	2001500..	60	m		
	RAL	200150099	60	m		
	golden oak (laminated) Renolit-No 2178 001	200150080	60	m		
		End slat SL KU - for covered stop -				
Standard end slat for all PVC and foamed roller shutter profiles suitable PVC connecting buffers: swiveling						
mill-finished		200100000	60	m		
standard colours		2001000..	60	m		
21 brown SF 26 white 9016 mat						
silver anodized EV 1		200100041	60	m		
bronze anodized BC 4 ..51, C 33 ..55		2001000..	60	m		
RAL		200100099	60	m		
		End slat SL A 9 - for covered stop -				
		Standard end slat for all single wall roller shutter profiles A 9 suitable PVC connecting buffers: swiveling				
	mill-finished	200200000	60	m		
	standard colours	2002000..	60	m		
	26 white 9016 mat					
	silver anodized EV 1	200200041	60	m		
	bronze anodized BC 4	2002000..	60	m		
RAL	200200099	60	m			

Please note: There is no stock service in bronze anodized BC 4 and C 33. A certain delivery time should be accepted. Brown SF is generally used as basic colour for golden oak lamination.

END SLATS FOR THE MINI SECTOR

MADE OF EXTRUDED ALUMINIUM

ALUKON

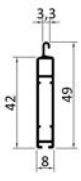
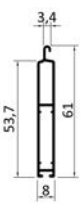

	Product description	article no.	p.u. m	Unit	price €	
	End slat SL DB.2 - for covered stop -					
	Standard end slat for all PVC and foamed roller shutter profiles, with groove for PVC and brush inserts suitable PVC connecting buffers: swiveling					
	mill-finished	200410000	60	m		
	standard colours	2004100..	60	m		
	03 nougat brown 08 silver 21 brown SF 26 white 9016 mat	27 cream white 82 charcoal 84 light ivory				
	silver anodized EV 1	200410041	60	m		
	bronze anodized BC 4 ..51, C 33 ..55	2004100..	60	m		
	RAL	200410099	60	m		
	End slat SL 60 - for covered stop -					
	Standard end slat for all PVC and foamed roller shutter profiles, with groove for PVC and brush inserts - with dou- ble-sided lamination - suitable PVC connecting buffers: swiveling					
	mill-finished	200600000	60	m		
	standard colours	2006000..	60	m		
	08 silver 21 brown SF 26 white 9016 mat	27 cream white 82 charcoal 84 light ivory				
	silver anodized EV 1	200600041	60	m		
	bronze Anodized BC 4 bronze anodized BC 4	2006000..	60	m		
	RAL	200600099	60	m		

Please note: There is no stock service in bronze anodized BC 4 and C 33. A certain delivery time should be accepted.

ANGLE END SLAT FOR THE MINI SECTOR

MADE OF EXTRUDED ALUMINIUM

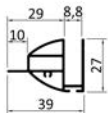
ALUKON



	Product description	article no.	p.u. m	Unit	price €
	Angle end slat SL-ES				
	Special end slat to screw on SL DB.2, with groove below for PVC and brush inserts suitable PVC connecting buffers: swiveling				
	mill-finished	200500000	6	m	
	standard colours	2005000..	6	m	
	26 white 9016 mat				
	silver anodized EV 1	200500041	6	m	
	bronze anodized BC 4 ..51, C 33 ..55	2005000..	6	m	
RAL	200500099	6	m		
	End cap for SL-ES				
	made of PVC, to be connected laterally on the angle of SL-ES				
	black	209060100	10	pair	

Please note: There is no stock service in bronze anodized BC 4 and C 33. A certain delivery time should be accepted.

SPECIAL END SLATS AND CENTRAL SLATS

MADE OF EXTRUDED ALUMINIUM

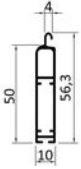
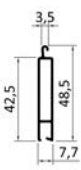
ALUKON

	Product description	article no.	p.u. m	Unit	price €
	End slat SL 521-DB.2 - for covered stop -				
	Special end slat for foamed aluminium roller shutter profile M 521, M 528, KM 521 with mini guide channels, with groove for PVC and brush inserts suitable PVC connecting buffers: swiveling.				
	mill-finished	201600000	60	m	
	standard colours	2016000..	60	m	
	21 brown SF	26 white 9016 mat			
	silver anodized EV 1	201600041	60	m	
	bronze anodized BC 4	201600051	60	m	
	RAL	201600099	60	m	
	Central profile MS				
	mill-finished	200900000	60	m	
	standard colours	2009000..	60	m	
	21 brown SF	26 white 9016 mat			
	RAL	200900099	60	m	
	Design end slat with groove for PVC insert - for leftroller -				
	mill-finished	200460000	60	m	
	standard colours	2004600..	60	m	
	RAL	200460099	60	m	
	End cap for Design end slat, black				
	two-parts	209060420	20	pair	

Please note: There is no stock service in bronze anodized BC 4 and C 33. A certain delivery time should be accepted.



END SLATS FOR THE NEW BUILDING SECTOR

MADE OF EXTRUDED ALUMINIUM

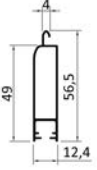
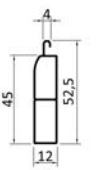

ALUKON

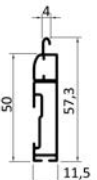
	Product description	article no.	p.u. m	Unit	price €
	End slat SL NG for new building sector				
	End slat for new buildings for all PVC and foamed roller shutter profiles M 521, M 528, KM 521, M 551, M 558 with groove for PVC insert				
	mill-finished	201500000	60	m	
	standard colours	2015000..	60	m	
	03 nougat brown 21 brown SF 87	26 white 9016 mat telegrey 7047 mat			
	silver anodized EV 1	201500041	60	m	
	bronze anodized BC 4	201500051	60	m	
	RAL	201500099	60	m	
	End slat SL NB for new building sector				
	End slat for new buildings for all PVC and foamed roller shutter profiles M 521, M 528, KM 521, M 551, M 558				
	mill-finished	201000000	60	m	
	standard colours	2010000..	60	m	
	26 white 9016 mat				
	silver anodized EV 1	201000041	60	m	
	bronze anodized BC 4 ..51, C 33 ..55	2010000..	60	m	
	RAL	201000099	60	m	

Please note: There is no stock service in bronze anodized BC 4 and C 33. A certain delivery time should be accepted.

	Product description	article no.	p.u. m	Unit	price €
	Angle end slat W-SL				
	End slat for new buildings (for removable angle stop) for all PVC and foamed roller shutter profiles M 521, M 528, KM 521, M 551, M 558 with groove for PVC insert				
	mill-finished	201300000	60	m	
	standard colours	2013000..	60	m	
	21 brown SF	26 white 9016 mat			
	silver anodized EV 1	201300041	60	m	
	bronze anodized BC 4 ..51, C 33 ..55	2013000..	60	m	
RAL	201300099	60	m		
	Angle stop				
	Angle stop, removable for angle end slat				
	mill-finished	201400000	60	m	
	standard colours	2014000..	60	m	
	21 brown SF	26 white 9016 mat			
	silver anodized EV 1	201400041	60	m	
	bronze anodized BC 4 ..51, C 33 ..55	2014000..	60	m	
RAL	201400099	60	m		
	Bracket 13 mm				
	Bracket, detachable for angle end slat with 13 mm outreach				
	mill-finished	201413000	60	m	
	standard colours	2014130..	60	m	
	silver anodized EV 1	201413041	60	m	
	bronze anodized BC 4 ..51, C 33 ..55	2014130..	60	m	
RAL	201413099	60	m		



Please note: There is no stock service in bronze anodized BC 4 and C 33. A certain delivery time should be accepted.
Bracket 13 mm: Please note: This article is only on stock in mill-finished version. Therefore, a certain delivery time has to be calculated.



	Product description	article no.	p.u. m	Unit	price €
	PVC end profile				
	for SL DB.2, SL AS-N, SL 60 and SL SO	209120000	6	m	
	for SL KU-N, Design SL	209150000	6	m	
	for SL NG, SL 521-DB and WSL	209130000	6	m	
	Brush seal (end profile)				
	for SL DB.2, SL AS-N, SL 60, SL SO	209110090	450	m	
	for SL KU-N, Design SL	209160090	550	m	
	Reinforcement iron				
	galvanized 18 x 3 mm for all mini end slats and SL SO	209220500	6	m	
Surcharges					
	Extra charge threaded PVC insert*	209910100		m	
	extra charge threaded brush*	209910200		m	
	Extra charge for brushes and inserts in small quantities (per piece)	890000200		pce	

Cranked end slat inserts are only possible as a full Packing Unit and with a delivery time of 4 weeks.

CONNECTING BUFFERS FOR MINI-END SLATS (COVERED STOPS)

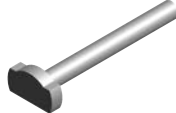
ALUKON

	Product description	article no.	p.u. m	Unit	price €
	Connecting buffer VB swiveling				
	Made of premium PVC for end slats SL KU, SL-KU-N, SL DB.2, SL ES, SL 60, SL 521-DB.2 and SL A 9				
	white	209032100	200	pce	
	black	209032200	200	pce	
	Connecting buffer, fixed				
	Made of premium PVC for end slats SL KU, SL-KU-N, SL 60, SL AS-N and SL A 9				
	white	209010100	100	pair	
	black	209010200	100	pair	
	Connecting buffer, swiveling				
	Extra solid and impact resistant for end slats SL DB.2 and SL 521-DB.2 (not applicable for 45 mm guide channel)				
	white	209030000	100	pair	
	screws for SL DB.2 (price per 100 pieces)	209210000	1000	pce	

	Product description	article no.	p.u. m	Unit	price €
	Angle stop (with brass screws)				
	white	891030100	10	pce	
	brown	891030200	10	pce	
	grey	891030300	10	pce	
	Stopper 28 mm (with fixing screws)				
	white	891041100	100	pce	
	brown	891041200	100	pce	
	grey	891041300	100	pce	
	black	891041400	100	pce	
	beige	891041600	100	pce	
	Stopper 40 mm (with fixing screws)				
	white	891040100	100	pce	
	brown	891040200	100	pce	
	grey	891040300	100	pce	
	black	891040400	100	pce	
	beige	891040600	100	pce	
	Stopper 60 mm (with fixing screws)				
	white	891042100	100	pce	
	brown	891042200	100	pce	
	grey	891042300	100	pce	
	black	891042400	100	pce	
	beige	891042600	100	pce	

10 WELLEN

AUS STAHL, TELESKOPWELLEN, WELLENBOLZEN, ZWISCHENLAGER UND FEDERSICHERUNGEN

Tubes en acier, tubes télescopiques, embouts d'axe, support intermédiaire et ressorts de sécurité





Steel shafts, telescope shafts, shaft bolts, intermediate supports and security springs

Hliníkové a ocelové hřídele, teleskop. hřídele, hřídelové čepy, držáky a uložení, závěsy a pérové pojistky





Stalowe wałki, wałki teleskopowe, końcówki wałka, łożyska środkowe i wieszaki

Stalen assen, telescopische assen, asproppen, tussenlagers, ophangveren

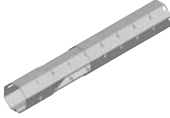
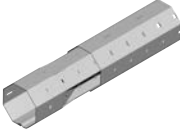
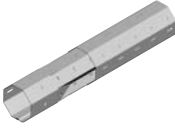
Acél tengelyek, teleszkóp tengelyek, tengelycsapok, közbenső csapágyak és feltolás gátlók

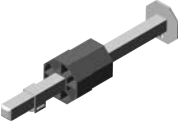
	Product description	article no.	p.u. m	Unit	price €
	Steel octagonal shaft $\varnothing = 40$ mm				
	Steel octagonal shaft 40 x 0,6 mm	220300300	6	m	
	Steel octagonal shaft 40 x 0,8 mm	220300400	6	m	
	Steel octagonal shaft $\varnothing = 40$ mm (fold outside - especially for electric operation)				
	Steel octagonal shaft 40 x 0,6mm	220300200	6	m	
	Steel octagonal shaft $\varnothing = 50$ mm				
	Steel octagonal shaft 50 x 0,6 mm	220300700	6	m	
	PVC intermediate support				
	PVC intermediate support $\varnothing 85$ mm for 40 mm octagonal shaft (with bearing)	229020000	1	pce	
	Steel octagonal shaft $\varnothing 60$ mm				
	Steel octagonal shaft 60 x 0,6 mm	220300500	6	m	
	Steel octagonal shaft 60 x 0,9 mm	220300600	6	m	
	PVC sleeve				
	PVC-sleeve $\varnothing 80$ mm for 60 x 0,6 mm steel octagonal shaft (needed when using profile M 551 / M 558 in combination with 60 mm octagonal steel shaft)	229010100	1	pce	
	Steel octagonal shaft $\varnothing 70$ mm				
	Steel octagonal shaft 70 x 1,0 mm	220300800	6	m	

	Product description	article no.	p.u. m	Unit	price €
	Telescope shaft mini for 40 mm octagonal shaft L= 300 mm, 150 x 40 mm	229040100	1	pce	
	Telescope shaft mini for 50 mm octagonal shaft L= 400 mm, 200 x 50 mm	229040300	1	pce	
	Telescope shaft mini for 60 mm octagonal shaft L= 500 mm, 250 x 60 mm	229040200	1	pce	

	Product description	article no.	p.u. m	Unit	price €
	Shaft bolts with ball bearing				
	for octagonal shaft 60 mm, with PVC roller cap	249410700	1	pce	
	Bearing for complete boxes				
	as holder	249430300	1	pce	
	Shaft bolt for safety brake				
	for octagonal shaft 60 mm, with PVC roller cap and square pin 18 x 18 mm	249411300	1	pce	
	Double shaft bolt				
	for octagonal shaft 50 mm, with PVC roller cap and ball bearing	249411000	1	pce	
	Bearing for complete boxes				
	as holder	249430300	1	pce	
	Double shaft bolt				
	for octagonal shaft 60 mm, with PVC roller cap and ball bearing	249411100	1	pce	
	Holder				
	for double shaft bolt (60 mm octagonal shaft)	249420100	1	pair	

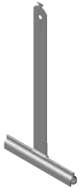
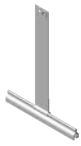
	Product description	article no.	p.u. m	Unit	price €
	Spring bolt (steel strap suspension) made of metal, PVC coated to hinge, rivet or screw				
	mini no. 1, length 136 mm	211100500	250	pce	
	mini no. 2, length 174 mm	211100600	250	pce	
	mini A 9, length 99 mm	211100900	250	pce	
	mini A9, length 125 mm	211100800	250	pce	
	new building no. 3, length 190 mm	211100700	250	pce	
	Spring bolt (steel strap suspension) with holding bracket, for octagonal shaft Ø 40 mm made of metal, PVC coated to hinge				
	mini, length 125 mm	211110100	250	pce	

Recommended use

type of profil	box size	tape	bevel drive / tape gear / AGS / ASG	motor shaft 40 mm	motor shaft 60 mm
M 317	< 165	Mini 1	holding bracket	holding bracket	Mini 1
	> 165	Mini 2	holding bracket	holding bracket	Mini 1
M 328-N	< 165	Mini 1	holding bracket	holding bracket	Mini 1
	> 165	Mini 2	holding bracket	holding bracket	Mini 1
KM 317	< 165	Mini 1	holding bracket	holding bracket	Mini 1
	> 165	Mini 2	holding bracket	holding bracket	Mini 1
MY 442 / 448	125 - 205	Mini 2	holding bracket	holding bracket	Mini 1
M 521 / 528	138 - 205	Mini 2	holding bracket	holding bracket	Mini 1
A 9	≤ 100	Mini A 9 (99)	-	-	-
	> 100	Mini A 9 (125)	Mini A 9 (125)	-	-

11 GURTSCHIEBEN

WICKLER, GURTGETRIEBE, KUGELLAGER, WALZENKAPPEN, ADAPTER UND ZUBEHÖR

Poulies, enrouleurs, treuils à sangle, roulements à billes, embouts d'axe, adaptateurs et accessoires

Pulleys, coilers, belt drives, roll bearings, roller caps, adapter and accessories

Řemenice, navíječe, páskové převodovky, kuličková ložiska, válcové zátky, adaptéry a příslušenství

Koła nawojowe, zwijacze, przekładnie paska, łożyska, sworznie, adaptery i elementy dodatkowe (akcesoria)

Bandschijven, bandopwinders, windwerken, kogellagers, asproppen, bandgeleiders, band, koord, koordgeleiders

Hevedertárcsa, automata, heveder hajtómű, csapágyak, hengeres sapka, adapterek és tartozékok

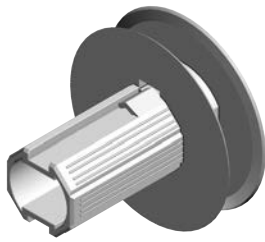







Special pulleys (length 65 mm)
 . for 40 mm octagonal shaft
 . for tape operation made of ABS
 . for cord operation made of Polyamid
 . use of special pulleys makes it possible to change the shafts

Polyamid pulleys are especially made for cord operation. Thanks to the elastic polyamid material, the pulley can not break while the cord will be wound up.

List of articles including prices in €/m

Article no.	description	size		Ø outside in mm	Ø inside in mm	material	pce	Price
		without IS	with IS					
260750100	GSV 75	100	-	75	47	ABS	100	
260900100	GSV 90	100	-	90	47	ABS	100	
260900200	GSV 90	100	-	90	47	Polyamid	100	
261090100	GSV 109	125	138	109	59.5	ABS	100	
261090200	GSV 109	125	138	109	59.5	Polyamid	100	
261250100	GSV 125	138	150	117.8	87.5	ABS	100	
261250200	GSV 125	138	150	117.8	87.5	Polyamid	100	
261350100	GSV 135	150	165	134.7	88	ABS	100	
261350200	GSV 135	150	165	134.7	88	Polyamid	100	
261550100	GSV 155	165	180	152	90	ABS	50	
261550200	GSV 155	165	180	152	90	Polyamid	50	
261700100	GSV 170	180, 205	-	162.5	102	ABS	50	



	Product description	article no.	p.u. m	Unit	price €
	Slide bearing ø 12 mm for pulleys and roller caps without edge	269020000	200	pce	
	Ball bearing Ø 12 mm for pulleys and roller caps without edge	269120000	100	pce	
	Ball bearing Ø 12 mm for pulleys and roller caps with edge	269130000	100	pce	

	Product description	article no.	p.u. m	Unit	price €
	Roller cap, length 40 mm				
	for 40 mm shaft with bearing intake 28 mm without ball bearing	079120000	100	pce	
	Roller cap, length 67 mm				
	for 40 mm shaft with bearing intake 28 mm without ball bearing	249410200	1	pce	
	Roller cap, length 104 mm				
	for 40 mm shaft with bearing intake 28 mm without ball bearing	249412300	1	pce	
	Roller cap, length 125 mm				
	for 50 mm shaft with bearing intake 28 mm without ball bearing	241031100	1	pce	

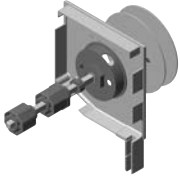
	Product description	article no.	p.u. m	Unit	price €
	Adapter for 60 mm shaft for GSV	229010000	100	pce	
	Roller cap, length 72 mm with steel tenon (ø 12 mm) outside	249410500	1	pce	
	Roller cap, length 150 mm with bearing intake 28 mm without ball bearing	249410400	1	pce	
	Roller cap, length 150 mm with steel tenon (ø 12 mm) outside (for new building boxes)	249411200	1	pce	
	Tradi roller capsule 115 mm long with square mount fopr 60 mm shaft	249800600	100	pce	
	Tradi belt pulley with square mount Ø 155 mm outside f. 14 mm belt	249800700	100	pce	
	Tradi square Dim: 10x10x80 mm, steel, galvanised	249800800	250	pce	



	Product description	article no.	p.u. m	Unit	price €
	adjustable external pulley AGS • adjustable to approx. 100 mm • tape can be changed without demounting the assembly unit • use for tape only • not qualified for large and heavy curtains (curtain weight > 5 kg 2 m ² area) • available from box size 100	265000000	25	pce	



PULLEYS FOR THE NEW BUILDING SECTOR AND STEEL PULLEYS FOR 23 MM TAPE FOR BUILT-IN



	Product description	article no.	p.u. m	Unit	price €
	Pulleys new buildings, 170 mm				
	Pulley new building 130 mm for 60 mm shaft	267011300	1	pce	
	Pulley new building 170 mm for 60 mm shaft	267011700	1	pce	
	SGS 100 steel pulley for 40 mm shaft	267100100	1	pce	
	SGS 115 steel pulley for 40 mm shaft	267115100	1	pce	
	SGS 138 steel pulley for 40 mm shaft	267138100	1	pce	
	SGS 115 steel pulley for 60 mm shaft	267115200	1	pce	
	SGS 138 steel pulley for 60 mm shaft	267138200	1	pce	
	SGS 150 steel pulley for 60 mm shaft	267150200	1	pce	

TAPE GEAR 2:1

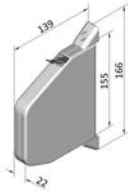
AND ACCESSORIES FOR TAPE 14 MM

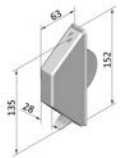
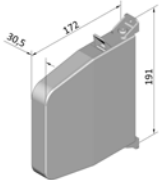



	Product description	article no.	p.u. m	Unit	price €
	Tape gear • to be used for heavier roller shutter curtains • can be used for a maximum weight of approx. 20 kg • (reduction gear tape coiler is requested, please see p. 11.8)				
	Tape gear 2:1 without pulley	240110000	1	pce	
	PVC roller cap	240110900	1	pce	
	Pulley 125 mm	240110100	1	pce	
	Pulley 140 mm	240110200	1	pce	
	Pulley 150 mmpulley 150 mm	240110300	1	pce	
	Pulley 165 mm	240110400	1	pce	

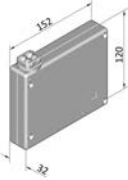

	Product description	article no.	p.u. m	Unit	price €
	Selve tape coiler swivel mounted, with hinge				
	white without tape	282100100	50	pce	
	brown without tape	282100200	50	pce	
	white with 5 m tape	282110100	50	pce	
	brown with 5 m tape	282110200	50	pce	
	Siral tape coiler swivel mounted				
	white without tape	282120100	100	pce	
	brown without tape	282120200	100	pce	
	Selve tape coiler provided with screws				
	white without tape	281100100	50	pce	
	white with 5 m tape	281110100	50	pce	
	brown with 5 m tape	281110200	50	pce	
	Selve flush-mounted tape coiler with flush-mounted box				
	white without tape	283100100	50	pce	
	brown without tape	283100200	50	pce	
	white with 5 m tape	283110100	50	pce	
	brown with 5 m tape	283110200	50	pce	
	Selve semi flush-mounted tape coiler				
	white without tape	284100100	50	pce	
	brown without tape	284100200	50	pce	
	white with 5 m tape	284110100	50	pce	
	brown with 5 m tape	284110200	50	pce	
	Selve tape coiler for transmission gearbox swivel mounted				
	white without tape	286100100	20	pce	
	brown without tape	286100200	20	pce	
	white with 11 m tape	286110100	5	pce	
	brown with 11 m tape	286110200	5	pce	

	Product description	article no.	p.u. m	Unit	price €
	Selve cord coiler swivel mounted, provided with screws				
	white without cord	282200100	50	pce	
	brown without cord	282200200	50	pce	
	white with 5 m cord	282220100	50	pce	
	brown with 5 m cord	282220200	50	pce	
	Selve cord gear coiler for transmission gears				
	white without cord	286200100	5	pce	

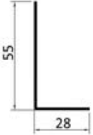
MINI CRANK COILER, SCREW-ON ANGLE, TAPE AND CORD

ALUKON

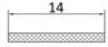

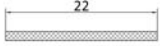

	Product description	article no.	p.u. m	Unit	price €
	Selve tape crank coiler without crank transmission ratio 2:1				
	white without tape	285100100	10	pce	
	brown without tape	285100200	10	pce	
	white with 5 m tape	285110100	10	pce	
	brown with 5 m tape	285110200	10	pce	
	Selve cord crank coiler without crank				
	white without cord	285200100	10	pce	
	brown without cord	285200200	10	pce	
	white with 5 m cord	285220100	10	pce	
	brown with 5 m cord	285220200	10	pce	
	Folding crank, 14 cm (mandatory for operation with crank winder)				
	for crank coiler	289330100	10	pce	
	Screw-on angle for lateral fixation of the crank and cord coilers				
	white	289310200	1	pce	
	brown	289310300	1	pce	
	Cord				
	white	289030100	500	m	

	Product description	article no.	p.u. m	Unit	price €
	Tape grey, 14 mm, both sides with slot hole for the mini-sector				
	length 5 m	289040105	100	pce	
	length 6 m	289040106	100	pce	
	length 7 m	289040107	100	pce	
	length 8 m	289040108	100	pce	
	length 11 m	289040111	100	pce	
	tape brown, 14 mm, both sides with slot hole for mini-sector				
	length 5 m	289040205	100	pce	
	length 6 m	289040206	100	pce	
	length 7 m	289040207	100	pce	
	length 8 m	289040208	100	pce	
	length 11 m	289040211	100	pce	
	tape beige, 14 mm, both sides with slot hole for mini-sector				
	length 5 m	289040305	100	pce	
	length 6 m	289040306	100	pce	
	length 7 m	289040307	100	pce	
	length 8 m	289040308	100	pce	
	length 11 m	289040311	100	pce	
	tape black and white, 14 mm, both sides with slot hole for mini-sector				
	length 5 m	289050105	100	pce	
length 6 m	289050106	100	pce		
length 7 m	289050107	100	pce		
length 8 m	289050108	100	pce		
length 11 m	289050111	100	pce		
	Tape for the mini-sector				
	grey	289040100	50	m	
	brown	289040200	50	m	
	light beige 14 mm	289040300	50	m	
	black-and-white 14 mm	289050100	50	m	
	tape grey, 22 mm, both sides with slot hole for new buildings				
	length 5 m	289020105	100	pce	
	length 6 m	289020106	100	pce	
	length 7 m	289020107	100	pce	
	length 8 m	289020108	100	pce	
	Tape 22 mm, grey				
	grey	289020100	50	m	
	cream white	289020200	50	m	

ACCESSORIES FOR THE MINI-SECTOR

(TAPE 14 MM)





ALUKON







	Product description	article no.	p.u. m	Unit	price €
	Tape guide, mini with brush				
	white	289110100	100	pce	
	brown	289110200	100	pce	
	Screw guide roller pin bearing				
	white	289130100	100	pce	
	black	289130200	100	pce	
	Tape guide roller pin bearing				
	white	289140100	100	pce	
	brown	289140200	100	pce	
	Wall guide roller, pin bearing				
	white	289160100	50	pce	
	black	289160200	50	pce	

ACCESSORIES FOR THE MINI-SECTOR

(TAPE 14 MM)

ALUKON





	Product description	article no.	p.u. m	Unit	price €
	PVC tube Ø 22 mm for wall duct 100 cm length	289170600	1	pce	
	Guide pulley pin bearing, made of synthetic material including cover Ø 50 mm				
	white	289150100	100	pce	
	black	289150200	100	pce	
	Deflect mechanism, pin bearing				
	metal	891310100	1	pce	
	PVC	891310200	1	pce	
	Diagonal deflection				
		891310300	1	pce	

	Product description	article no.	p.u. m	Unit	price €
	Tape guide				
	Tape guide for box extension	267990100	10	pce	
	PVC tube Ø 32 mm				
	for wall duct length 100 cm	289170500	1	pce	
	Guide pulley				
	PVC, white, with brush including cover plate	289170100	50	pce	
	Holder				
	Holder for tape guide GKÜ	267990200	10	pce	
	Bearing for complete boxes				
	as holder	249430300	1	pce	
	Ball bearing Ø 40 mm				
	with PVC inner ring inner diameter 12 mm	249430200	1	pce	



ACCESSORIES FOR THE NEW BUILDING SECTOR

(TAPE 22 MM)

ALUKON

	Product description	article no.	p.u. m	Unit	price €
	Flush mounted tape coiler Paro				
	135 mm hole gap	287110100	50	pce	
	161 mm hole gap	287100100	50	pce	
	Wall box				
	135 mm hole gap	287111100	50	pce	
	161 mm hole gap	287101100	50	pce	
	Tape guide for new building sector with brush				
	white	289120100	100	pce	
	brown	289120200	100	pce	
	Selve surface-mounted tape coiler Pivo				
	capsuled, movable, for 22 mm tape, spring with tension, white, without tape	287120100	25	pce	

	Product description	article no.	p.u. m	Unit	price €
	Cord guide roller steel roller pin bearing with transition plate				
	horizontal	289190100	100	pce	
	Cord guide roller steel roller pin bearing with mounting plate				
	vertical	289191100	100	pce	
	Cord guide roller steel roller pin bearing for installation at the box				
	white	289192100	100	pce	
	Deflection roller for cord				
	white	289220100	100	pce	
	brown	289220200	100	pce	

	Product description	article no.	p.u. m	Unit	price €
	Cord spring				
	short (100 mm)	289210000	100	pce	
	Cord spring				
	long (200 mm)	289210100	100	pce	
	Let-up support				
	white	289310100	1	pce	

12 MOTOREN

KURBELGETRIEBE UND ZUBEHÖR

Moteurs, engrenages par manivelle et accessoires

Drives, crank drives and accessories

Motory, klikové převodovky a příslušenství

Napędy, przekładnie korbowe oraz osprzęt dodatkowy

Buismotoren + toebehoren, stangwindwerken, kruiskoppelingen, stangen

Motorok, kurbli meghajtás és tartozékok

The tubular drive for all roller shutter elements with 40mm or 60mm octagonal shaft, without switch
 Nominal voltage: 230 V AC / 50 Hz // Protection rating: IP44

Mechanical switch-off

- Easy setting of final positions without special tools - no stoppers required
- Motor will switch-off automatically in case of overheating to avoid damage of motor and shutter
- to start operation a fixed stopper in the upper final position is obligatory as well as fixed anti-lift devices

Electronic switch-off: same advantages as mechanical switch-off but additionally





- with torque shut-off or punctual shut-off
- automatic balance of curtain length
- usable with and without anti-lift device (motors detects the anti-lift device automatically)
- motors for 40mm shaft from series P5 / P9 are only applicable with spring bolt
- blocking detection in UP-direction (e.g. freeze protection)
- parallel operation without cut-off relay







Integrated radio receiver: advantages are the same as for electronic switch-off and additionally





- wireless operation
- single, group and central control applicable with up to 16 transmitters





List of articles including prices in €/m





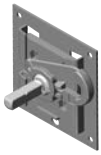

description	traction in kg up to height												in stock	length in cm	cable steckbar	Part no.	price / piece
	1,50 m			2,50 m			3,00 m			3,50 m							
	shaft 40 mm	shaft 60 mm	shaft 70 mm	shaft 40 mm	shaft 60 mm	shaft 70 mm	shaft 40 mm	shaft 60 mm	shaft 70 mm	shaft 40 mm	shaft 60 mm	shaft 70 mm					
with mechanical switch off, including adapter and driver																	
P 9/16 M	25			21			20			19			X	55,60	ja	247000100	
R 7/17 M (short)		11			9			8			7		X	41,40	nein	247010000	
R 4-M 17 (short)		9	8		8	8		8	7		7	7	X	37,30	nein	247010010	
R 8/17 M04		17	14		14	13		13	12		12	11	X	47,10	ja	247010100	
R 15/17 M04		33	28		27	25		25	23		23	21	X	47,10	ja	247010200	
R 25/17 M04		50	41		45	35		41	31		39	29	X	50,00	ja	247010700	
R 30/17 M04		63	56		53	49		49	46		46	44	X	62,40	ja	247010400	
with electronical switch off, including adapter and driver, Installation mit Federisierung oder festen Wellenverbindern																	
P 5-E01*	14	11		12	9		11	8		10	7		X	44,40	ja	247000200	
P 9-E01*	25	19		21	15		20	14		19	13		X	49,30	ja	247000300	
R 8/17-E03 (3 m cable)		17			14			13			12		X	53,00	nein	247012100	
R 8/17-E03 (5 m cable)		17			14			13			12		X	53,00	nein	247022100	
R 12/17-E03 (3 m cable)		26			21			20			19		X	53,00	nein	247012200	
R 12/17-E03 (5 m cable)		26			21			20			19		X	53,00	nein	247022200	
R 20/17-E03 (3 m cable)		43			36			33			31		X	55,90	nein	247012300	
R 20/17-E03 (5 m cable)		43			36			33			31		X	55,90	nein	247022300	
R 30/17-E03		63	56		53	49		49	46		46	44	X	58,30	nein	247011400	
Plug & Play, incl. Adapter und Mitnehmer, Installation nur mit festen Wellenverbindern																	
R 8/17 E26		17	14		14	13		13	12		12	11	X	52,80	ja	247019100	
R 12/17 E26		26	22		21	19		20	18		19	17	X	52,80	ja	247019200	
R 20/17 E26		43	37		36	32		33	31		31	29	X	55,70	ja	247019300	
R 30/17 E26		63	56		53	49		49	46		46	44	X	58,10	ja	247019400	
Centronic Plus Funk, incl. Adapter und Mitnehmer, Installation mit Federsicherung oder festen Wellenverbindern																	
P 5/16 C01 Plus*	14	11		12	9		11	8		10	7		X	47,70	ja	247014300	
P 9/16 C01 Plus*	25	19		21	15		20	14		19	13		X	50,40	ja	247014400	
R 8/17 C01 Plus		17	14		14	13		13	12		12	11	X	52,80	ja	247020100	
R 12/17 C01 Plus		26	22		21	19		20	18		19	17	X	52,80	ja	247020200	
R 20/17 C01 Plus		43	37		36	32		33	31		31	29	X	55,70	ja	247020300	
R 30/17 C01 Plus		63	56		53	49		49	46		46	44	X	58,10	ja	247020400	

	Product description	article no.	p.u. m	Unit	
	Wall transmitter EC 411				
		249371500	1	pce	
	Wall transmitter EC 415				
	5-channel, battery operated	249370600	1	pce	
	Handheld transmitter with wall holder, white				
	EC 541-II, 1-channel	249372300	1	pce	
	Handheld transmitter with wall holder, white				
	EC 545-II, 5-channel	249372700	1	pce	

	Product description	article no.	p.u. m	Unit	price €
	Handheld transmitter MC 441				
	1-channel "Memory" with wall holder	249370300	1	pce	
	Light sensor, radio controlled SC 431 for roller shutters				
	with sunshade and twilight function and integrated glass break sensors	249371200	1	pce	
	Sun / wind sensor for exterior blinds				
	Set including radio controlled handheld transmitter SWS 441	249371000	1	pce	
	Radio receiver VC 320 for roller shutters				
	(to convert a drive to radio control)	249370700	1	pce	
	Radio receiver Vario Control VC 420 +				
	Receiver for drive controlling of roller shutter and exterior blinds, recording wind and sun levels (including plastered box)	249371600	1	pce	
	Radio receiver Vario Control VC 470 +				
	for Hirschmann coupling, receiver for drive controlling of exterior blinds, recording wind and sun levels	249371700	1	pce	

	Product description	article no.	p.u. m	Unit	price €
	handheld control EC 541 Plus				
	1-channel	249376100	1	pce	
	handheld control EC 548 Plus				
	8-channel	249376200	1	pce	
	handheld control EC 5416 Plus				
	16-channel	249376300	1	pce	
	Control CC 41				
		249373300	1	pce	
	USB flash drive Centronic				
		249373400	1	pce	
	USB flash drive Centronic Plus				
		249373500	1	pce	

	Product description	article no.	p.u. m	Unit	price €
	Motor support plate R 8/17M (R) to R20/17M P 9/16 M				
	R 8/17M (R) to R 20/17M P 9/16M	246090300	1	pce	
	Motor flange for motor support plate Becker				
		247080104	1	pce	
	Motor support plate with pin up to 50 Nm for Becker motors 30/17+ 40/17 serie R				
	for motor 30/17 and 40/17 for Becker motor series R	246090900	1	pce	
	Pin R 3/20 round, d=20 mm				
		247080103	1	pce	
	Support for new building sector R8/17-40/1 with pin (Ø 20 mm) for Becker motors serie R				
	including stick pin (Ø 20 mm) for Becker motor series R	247080100	1	pce	

	Product description	article no.	p.u. m	Unit	price €
	Adapter + driver for shaft 50 mm	247080500	1	pce	
	Adapter + driver for shaft 60 mm	247080200	1	pce	
	Adapter + driver for shaft 70 mm	247080400	1	pce	
	Intermediate ring for alteration 40 mm to 60 mm shaft for motors P 9/16M, E 01, P5/P9-E01, P5/P 9-C01 (use only with adapter + driver for 50 mm or 60 mm shaft)				
	can only be used with adapter and driver for shaft 50 mm / 60 mm	247080600	1	pce	
	Installation set 1-pole white	247080300	1	pce	
	Plug-in cable for Becker motors				
	5 m length	247081200	1	pce	
	10 m length	247081300	1	pce	

The tubular motor for all roller shutter elements with 40mm or 60mm octagonal shaft, without switch.
Nominal voltage: 230 V / 50 Hz, Protection rating: IP44

Mechanical switch-off

- precise setting of final positions by knurled thumb screw with model LS or corresponding positioning buttons with model LT

Electronic switch-off







- with constant electronic torque control
- upper and lower end position can be adjusted torque controlled or fix (depending on type)
- blocking detection in UP-direction (e.g. freeze protection)
- with and without anti-lift device (Ilmo only in combination with anti-lift device)
- In combination with spring bolt the lower final position must be fixed (no anti-lift function)







Integrated radio receiver: advantages same as for electronic switch-off and additionally:

- wireless operation
- single, group and central control applicable with up to 12 transmitters







List of articles including prices in €/m

description	traction in kg up to height												in stock	length in cm	cable steckbar	Part no.	price / piece
	1,50 m			2,50 m			3,00 m			3,50 m							
	shaft 40 mm	shaft 60 mm	shaft 70 mm	shaft 40 mm	shaft 60 mm	shaft 70 mm	shaft 40 mm	shaft 60 mm	shaft 70 mm	shaft 40 mm	shaft 60 mm	shaft 70 mm					
with mechanical switch off, including adapter and driver																	
S 4/16 (short) - Aries	12	11		10	9		8	7		6	5		X	41,10	nein	240401600	
9/16 - Mars	22			18			16			14			X	45,40	nein	240401700	
6/17 - Start		13	12		10	9		9	7		8	5	X	52,50	ja	241000100	
8/17 NHK - Jet		18			16			13			11		X	67,50	ja	240403200	
15/17 - Atlas		33	29		29	25		24	22		23	22	X	54,50	ja	241000300	
Plug&Play with electronical switch off, including adapter and driver, Installation nur mit festen Wellenverbindern																	
WT 6/17 - Ilmo 50 S (k)		12			9			8			7		X	38,70	nein	241025000	
WT 6/17 - Ilmo		12	12		9	9		8	7		7	5	X	52,50	ja	241025100	
WT 10/17 - Ilmo		21	20		17	16		15	14		13	12	X	52,50	ja	241025200	
WT 15/17 - Ilmo		32	28		26	22		22	19		20	18	X	54,50	ja	241025300	
WT 20/17 - Ilmo		43	37		34	30		29	27		26	24	X	67,50	ja	241025400	
WT 30/17 - Ilmo		64	55		51	46		44	41		43	38	X	69,50	ja	241025500	
RTS radio controlled drives, including adapter and driver, Installation mit Federsicherung oder festen Wellenverbindern																	
RTS 6/17 - Oximo 50 S (k)		12			9			8			7		X	38,70	nein	241020000	
RTS 6/17 - Oximo		12	12		9	9		8	7		7	5	X	62,50	ja	241020100	
RTS 10/17 - Oximo		21	20		17	16		15	14		13	12	X	62,50	ja	241020200	
RTS 15/17 - Oximo		32	28		26	22		22	19		20	18	X	67,50	ja	241020300	
RTS 20/17 - Oximo		43	37		34	30		29	27		26	24	X	67,50	ja	241020400	
RTS 30/17 - Oximo		64	55		51	46		44	41		43	38	X	69,50	ja	241020500	
io radio controlled drives, including adapter and driver, Installation mit Federsicherung oder festen Wellenverbindern																	
io 4/16 - Oximo		12			10			8			8		X	47,50	nein	241026700	
io 9/16 - Oximo		24			20			20			19		X	51,00	nein	241026800	
io 13/10 - Oximo		36			31			29			27		X	51,00	nein	241026900	
io 6/17 - Oximo 50 S (k)		12			9			8			7		X	38,70	nein	241026000	
io 6/17 - Oximo		12	12		9	9		8	7		7	5	X	62,50	ja	241026100	
io 10/17 - Oximo		21	20		17	16		15	14		13	12	X	62,50	ja	241026200	
io 15/17 - Oximo		32	28		26	22		22	19		20	18	X	67,50	ja	241026300	
io 20/17 - Oximo		43	37		34	30		29	27		26	24	X	67,50	ja	241026400	
RS 100 io 6/17		12	12		9	9		8	7		7	5	X	48,40	ja	241028100	
RS 100 io 10/17		21	20		17	16		15	14		13	12	X	49,80	ja	241028200	
RS 100 io 15/17		32	28		26	22		22	19		20	18	X	54,10	ja	241028300	

	Product description	article no.	p.u. m	Unit	price €
	Wall transmitter Situo 1-channel for Somfy RTS	249351500	1	pce	
	Handheld transmitter Situo 1 RTS Pure II including wall holder	249350100	1	pce	
	Handheld transmitter Situo 5 RTS Pure II including wall holder	249350200	1	pce	
	Handheld transmitter Telis pure 16-channel for Somfy RTS including wall holder	249351800	1	pce	
	Handheld transmitter with timer Telis 6 Chronis pure 6-channel 6-channel, for Somfy RTS, including wall holder	249351700	1	pce	
	Wall radio transmitter, Smoove Origin RTS with frame and cover	249351600	1	pce	
	Radio receiver Centralis Indoor RTS with frame (to convert a drive to radio control)	249350900	1	pce	

	Product description	article no.	p.u. m	Unit	price €
	Radio receiver Centralis Platine RTS (to convert a drive to radio control)	249351300	1	pce	
	Timer UP Uno Smart including cover "Inteo" and frame	249351400	1	pce	
	Handheld transmitter Situo 1 io pure II 1-channel including wall holder	249353100	1	pce	
	handheld control Situo 5 io pure II 5-channel	249353400	1	pce	
	Wall radio transmitter io, Smoove 1 Origin io with frame pure and cover	249353200	1	pce	
	wall transmitter Smoove Origin RS 100 io radio with frame pure and cover	249353300	1	pce	





	Product description	article no.	p.u. m	Unit	price €
	Universal drive support for LS 40 (bearing plate + retaining clip)	241030100	1	pce	
	Universal drive support for end cap system including spring washer with small loop for Somfy-HiPro	241030200	1	pce	
	Drive bearing for complete boxes including spring washer with large loop	241030300	1	pce	
	Adaption kit for LS 40/LT 50 Motor Aries + Oximo RTS 40 DC including adapter and driver	241030600	1	pce	
	Plug-in cable				
	for Somfy RTS, io 3,00 m	241040100	1	pce	
	for Somfy RTS, io 5,00 m	241040200	1	pce	
	for Somfy RTS, io 10,00 m	241040700	1	pce	
	for Somfy-HiPro 3,00 m	241040300	1	pce	
	for Somfy-HiPro 5,00 m	241040400	1	pce	
	for Somfy-HiPro 10,00 m	241040500	1	pce	
	Adapter for LS 40				
	for octagonal shaft 40 mm	245070100	1	pce	
	universal mounting and adjustment cable for all Somfy 230V AC drives with StaK3-coupling incl. adapter cable with single clamps	241030400	1	pce	



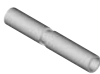

	Product description	article no.	p.u. m	Unit	price €
	Driver for LS 40				
	for octagonal shaft 40 mm	245070200	1	pce	
	Adapter for LT 50				
	for octagonal shaft 50 mm	245070300	1	pce	
	Driver for LT 50				
	for octagonal shaft 50 mm	245070400	1	pce	
	Adapter for LT 50				
	for octagonal shaft 60 mm	245070500	1	pce	
	Driver for LT 50				
	for octagonal shaft 60 mm	245070600	1	pce	
	Adapter for LT 50				
	for octagonal shaft 70 mm	245070700	1	pce	
	Driver for LT 50				
	for octagonal shaft 70 mm	245070800	1	pce	

SWITCHES AND ACCESSORIES FOR BECKER AND SOMFY-DRIVES



ALUKON





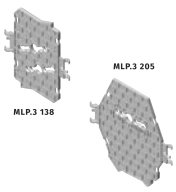

	Product description	article no.	p.u. m	Unit	price €
	Push-button surface mounted				
	button	249310100	1	pce	
	switch	249310200	1	pce	
	switch (splash waterproof)	249310700	1	pce	
	Push-button flush mounted				
	button	249312400	1	pce	
	switch	249312300	1	pce	
	Key push-button "Universal" surface mounted				
		380320700	1	pce	
	Key push-button "Universal" flush mounted				
		380320800	1	pce	
	Spring bolt SecuFix, 150, shaft 60mm				
	1-part	249221201	250	pce	
	Spring bolt SecuFix, 165-180, shaft 60mm				
	2-part	249221301	250	pce	
	Spring bolt SecuFix, 205-255, shaft 60mm				
	3-part	249221401	250	pce	





	Product description	article no.	p.u. m	Unit	price €
	Loop 165 mm for Somfy motor with emergency crank handle	382010100	1	pce	
	Loop 225 mm for Somfy motor with emergency crank handle	382010200	1	pce	
	Angle crank for emergency crank handle, removable				
	120 cm	382020200	1	pce	
	163 cm	382020100	1	pce	
	Connection tube 15 x 1,5 mm aluminium natural round tube linkage for emergency crank handle	240302200	6	m	
	Clamp holder PVC				
	clamp grey	249220400	1	pce	
	Cut-off relay TR 1				
		249313100	1	pce	





	Product description	article no.	p.u. m	Unit	price €
	Motor solar RS 100 io for steel shaft 60 , with cable 22 cm				
	3/15 Nm	241021100	1	pce	
	6/15 Nm	241021200	1	pce	
	10/12 Nm	241021300	1	pce	
	15/12 Nm	241021400	1	pce	
	20/12 Nm	241021500	1	pce	
	Solarkit 6/18				
	consisting of: Oximo 40 DC io solar drive 6/18, 2 solar panel, battery	241050500	1	pce	
	Solarkit 10/12				
	consisting of: Oximo 40 DC io solar drive 10/12, 2 solar panel, battery	241050600	1	pce	
	Solar panel				
		241055101	1	pce	
		241055102	1	pce	
	ASI-technologie (amorphus silicium)	241055100	1	pce	
	Accumulator				
		241055201	1	pce	
		241055202	1	pce	
	12 V NiMH-battery with splash waterproofed box IP 44	241055200	1	pce	
	Charger				
	for RS 100 io solar drives, Oximo io /RTS	241055301	1	pce	



	Product description	article no.	p.u. m	Unit	price €
	MLP 100 grey	249041100	20	pce	
	MLP.3 125 mill-finished	249043000	50	pce	
	MLP.3 138 mill-finished	249043100	50	pce	
	MLP.3 150 mill-finished	249043200	50	pce	
	MLP.3 165 mill-finished	249043300	50	pce	
	MLP.3 180 mill-finished	249043400	50	pce	
	MLP.3 205 mill-finished	249043500	50	pce	







	Product description	article no.	p.u. m	Unit	price €
	Bevel drive 2:1 for 40 mm shaft (without linkage)				
	for installation without screws gear unit on the left, free-wheeling on the left	240300100	1	pce	
	for installation without screws gear unit on the right, free-wheeling on the right	240300200	1	pce	
	to screw, gear unit on the left, free-wheeling on the left	240300400	1	pce	
	to screw, gear unit on the right, free-wheeling on the right	240300500	1	pce	
	Bevel drive 3:1 for 40 mm shaft (without linkage)				
	for installation without screws gear unit on the left, free-wheeling on the left	240300600	1	pce	
	for installation without screws gear unit on the right, free-wheeling on the right	240300700	1	pce	
	to screw, gear unit on the left, free-wheeling on the left	240301400	1	pce	
	to screw, gear unit on the right, free-wheeling on the right	240301500	1	pce	
	to screw with limited rotation	240301100	1	pce	
	Bevel drive 4:1 (without linkage)				
	to screw on 40 mm shaft, gear unit on the left, free-wheeling on the left	240301200	1	pce	
	to screw on 40 mm shaft, gear unit on the right, free-wheeling on the right	240301300	1	pce	
	to screw on 60 mm shaft, gear unit on the left, free-wheeling on the left	240301600	1	pce	
	to screw on 60 mm shaft, gear unit on the right, free-wheeling on the right	240301700	1	pce	



	Product description	article no.	p.u. m	Unit	price €
	Linkage white, section tube				
	L = 100 cm	240310601	1	pce	
	L = 110 cm	240310701	1	pce	
	L = 120 cm	240310101	1	pce	
	L = 130 cm	240310201	1	pce	
	L = 140 cm	240310301	1	pce	
	L = 150 cm	240310401	1	pce	
	L = 160 cm	240310501	1	pce	
	L = 200 cm	240310901	1	pce	
	Linkage silver, section tube				
	L = 110 cm	240320201	1	pce	
	L = 120 cm	240320301	1	pce	
	L = 130 cm	240320401	1	pce	
	L = 140 cm	240320101	1	pce	
L = 200 cm	240320901	1	pce		
	Joint bearing 45 - 90° 22 x 85 mm with 6 mm square bar				
	22 x 85 mm with 6 mm square pin, 6 mm	240302300	1	pce	
	Joint bearing 45 - 90° with diagonal deflection 45°				
	with diagonal deflection 45°	240302700	1	pce	
	Cardan joint with 6 mm square pin (length 120 mm)				
	with 6 mm square pin (length 120 mm) in combination with joint bearing 45°	240302600	1	pce	
	Joint bearing for bevel drive base plate 22 x 52 mm				
	Base plate 22 x 52 mm	240303300	1	pce	
	Spherical plain 90° bearing for worm gearbox 22 x 85 mm				
	for TRADI NEO - downward outlet with 6 mm hexagon	240303800	1	pce	

	Product description	article no.	p.u. m	Unit	price €
	Square pin, length 526 mm for bevel drives 6 mm, galvanized				
	for bevel drives 6 mm, galvanized	240302100	1	pce	
	Square pin, length 726 mm for bevel drive 6 mm, galvanized				
	for bevel drives 6 mm, galvanized	240302900	1	pce	
	Connection tube 15 x 1,5 mm, aluminium				
	connection tube aluminium mill-finished	240302800	1	m	
	connection tube aluminium white	240302400	6	m	
	Clamp holder PVC grey for linkage, height 35 mm				
	clamp grey	249220400	1	pce	
	clamp white	249220500	1	pce	
	Locking clip				
	for bevel drive with linkage, white	249051900	1	pce	

	Product description	article no.	p.u. m	Unit	price €
	Coupling funnel for removable linkage for bevel drive with section tube for bevel drive with section tube	249220200	1	pce	
	Driver pin 4 x 24 for removable linkage for removable linkage	249220300	1	pce	
	Mill model including driller for bevel drive installation without screws, to remove the end cap journal for bevel drive installation without screws, to remove the end cap journal	240303100	1	pce	
	Washer plate 85 x 85 mm for all joint bearings with base plate 22 x 85, to cover large wall openings	249450100	1	pce	
	Washer plate 85 x 40 mm for all joint bearings with base plate 22 x 85, to cover large wall openings	249450200	1	pce	

	Product description	article no.	p.u. m	Unit	price €
	Worm gear 4:1 external for linkage with 6 mm square pin for shaft 40 mm up to 16 kg	240200600	1	pce	
	Tradi worm gear 4:1 for linkage with 6 mm hexagon with square mount	240200200	50	pce	

	Product description	article no.	p.u. m	Unit	price €
	Tradi side panel				
	steel, galvanised	249800100	100	pair	
	tradi linkage for universal bearing				
		249800200	100	pce	
	Tradi universal bearing				
	with star mount for motors	249800300	100	pce	
	Tradi plain bearing housing				
		249800400	100	pce	
	Tradi plan bearing				
	wiht square mount	249800500	100	pce	
					
		249800920	100	pce	
	Tradi circlip for universal bearing				
		249800900	100	pce	

	Product description	article no.	p.u. m	Unit	price €
	Tradi ceiling reinforcement	190290800	120	pce	
		249800910	250	pce	

13 INTEGRIERTER INSEKTENSCHUTZ FÜR ROLLADEN UND RAFFSTOREN

Moustiquaires intégrées pour volets roulants et BSO

Insect repelling system for roller shutters and venetian blinds

Program ochrony proti hmyzu integrowany do rolet. elementu

Elementy rolet zintegrowanych z siatką antyinsektową

Programma op basis van geintegreerde insektenwering

Integrált szúnyogháló redőnyhöz és zsalúziához

PRESSURE MOULDED END CAPS FOR INTEGRATED INSECT REPELLING SYSTEM

ALUKON

BEVELLED VERSION 20°

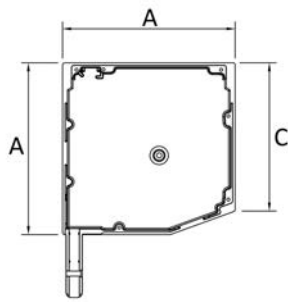

- made of special aluminium alloy
- with non-centered journal
- pressure moulded (cannot be anodized)
- end caps only available in pairs
- the listed standard colours are no RAL colours
- for elements with box size 205 mm, standard end caps will be used (please see chapter 4)

BKS-I-N	dimensions in mm		standard colours							bronze	
	A	C	00	03	08	21	26	82	09	25	99
138	139	117	✓	✓	✓	✓	✓	✓			
150	153	129	✓	✓	✓	✓	✓	✓			
165	168	145	✓	✓	✓	✓	✓	✓			
180	184	156	✓	✓	✓	✓	✓	✓			

available colours with colour no.

00 mill-finished

standard colours (no RAL)

03 nougat brown 26 white mat 9016
 08 silver 82 charcoal
 21 brown SF

bronze

09 coated similar BC 4 25 coated similar C 33

RAL

99 RAL

List of articles including prices in €/pair

description	part number + colour number (...)	unit Pa	mill-finished	standard colours	bronze	RAL
BKS-I-N 138	2313110..	10				
BKS-I-N 150	2315110..	10				
BKS-I-N 165	2316110..	10				
BKS-I-N 180	2318110..	10				

PRESSURE MOULDED END CAPS FOR INTEGRATED INSECT REPELLING SYSTEM

ALUKON

BEVELLED VERSION 45°

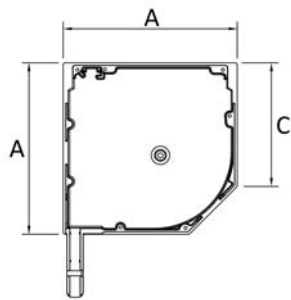

- made of special aluminium alloy
- with non-centered journal
- pressure moulded (cannot be anodized)
- end caps only available in pairs
- the listed standard colours are no RAL colours
- for elements with box size 205 mm, standard end caps will be used (please see chapter 4)

BKS-I	dimensions in mm		standard colours						
	A	C	00	03	08	21	26	82	99
138	139	103	✓		✓	✓	✓	✓	
150	153	112	✓	✓	✓	✓	✓	✓	
165	169	121	✓	✓	✓	✓	✓	✓	
180	184	133	✓		✓	✓	✓	✓	

available colours with colour no.

00 mill-finished

standard colours (no RAL)

03 nougat brown 26 white mat 9016
 08 silver 82 charcoal
 21 brown SF

RAL

99 RAL

List of articles including prices in €/pair

description	part number + colour number (...)	unit Pa	mill-finished	standard colours	RAL
BKS-I-N 138	2313150..	10			
BKS-I-N 150	2315150..	10			
BKS-I-N 165	2316150..	10			
BKS-I-N 180	2318150..	10			

PRESSURE MOULDED END CAPS FOR INTEGRATED INSECT REPELLING SYSTEM

ALUKON

RECTANGULAR VERSION 90°

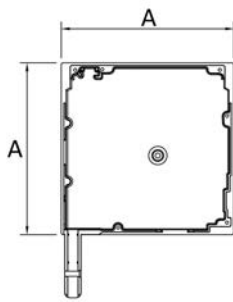

- made of special aluminium alloy
- with non-centered journal
- pressure moulded (cannot be anodized)
- end caps only available in pairs
- the listed standard colours are no RAL colours
- for elements with box size 205 mm, standard end caps will be used (please see chapter 4)

BK-I-N	dimensions in mm	standard colours				
		00	08	21	26	99
	A					
138	139	✓	✓			
150	153	✓	✓	✓	✓	
165	168	✓	✓		✓	
180	184	✓	✓	✓	✓	

available colours with colour no.

00 mill-finished

standard colours (no RAL)

08 silver
21 brown SF

26 white mat 9016

RAL

99 RAL

List of articles including prices in €/pair

description	part number + colour number (...)	unit Pa	mill-finished	standard colours	RAL
BK-I-N 138	2313120..	10			
BK-I-N 150	2315120..	10			
BK-I-N 165	2316120..	10			
BK-I-N 180	2318120..	10			

PRESSURE MOULDED END CAPS FOR INTEGRATED INSECT REPELLING SYSTEM

ALUKON

ROUND VERSION

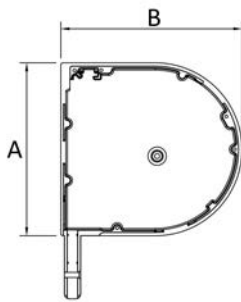

- made of special aluminium alloy
- with non-centered journal
- pressure moulded (cannot be anodized)
- end caps only available in pairs
- the listed standard colours are no RAL colours
- for elements with box size 205 mm, standard end caps will be used (please see capite 4)

BKR-I	dimensions in mm		standard colours							bronze	
	A	C	00	03	08	21	26	82	09	25	99
138	141	148	✓		✓	✓	✓	✓			
150	152	160	✓	✓	✓	✓	✓	✓			
165	169	176	✓	✓	✓	✓	✓	✓			
180	183	191	✓		✓	✓	✓				

available colours with colour no.

00 mill-finished

standard colours (no RAL)

03 nougat brown 26 white mat 9016
 08 silver 82 charcoal
 21 brown SF

bronze

09 coated similar BC 4 25 coated similar C 33

RAL

99 RAL

List of articles including prices in €/pair

description	part number + colour number (...)	unit Pa	mill-finished	standard colours	bronze	RAL
BKR-I-N 138	2313130..	10				
BKR-I-N 150	2315130..	10				
BKR-I-N 165	2316130..	10				
BKR-I-N 180	2318130..	10				

PRESSURE MOULDED END CAPS FOR INTEGRATED INSECT REPELLING SYSTEM

ALUKON

QUARTER ROUND VERSION

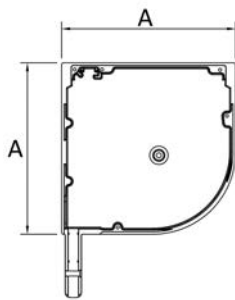

- made of special aluminium alloy
- with non-centered journal
- pressure moulded (cannot be anodized)
- end caps only available in pairs
- the listed standard colours are no RAL colours
- for elements with box size 205 mm, standard end caps will be used (please see chapter 4)

BKVR-I-N	dimensions in mm	standard colours				
		00	08	21	26	99
	A					
138	139	✓				
150	153	✓	✓	✓	✓	
165	169	✓	✓	✓	✓	
180	184	✓	✓	✓	✓	

available colours with colour no.

00 mill-finished

standard colours (no RAL)

08 silver
21 brown SF

26 white mat 9016

RAL

99 RAL

List of articles including prices in €/pair

description	part number + colour number (...)	unit Pa	mill-finished	standard colours	RAL
BKVR-I-N 138	2313140..	10			
BKVR-I-N 150	2315140..	10			
BKVR-I-N 165	2316140..	10			
BKVR-I-N 180	2318140..	10			

PRESSURE MOULDED END CAPS FOR INTEGRATED INSECT REPELLING SYSTEM

ALUKON

CENTRAL END CAP FOR COMBINATIONS



- without edge
- available with or without edge
- delivery in RAL 9005 mat or mill-finished
- guide channel terminal and addition pins have to be ordered separately







description	Part no. + color no. left side	Part no. + color no. right side	pce	mill-fin- ished	schwarz 9005 matt
MBK 138 without pin	2313001..05	2313002..05	5		
MBK 150 without pin	2315001..05	2315002..05	5		
MBK 165 without pin	2316001..05	2316002..05	5		
MBK 180 without pin	2318001..05	2318002..05	5		

	Product description	article no.	p.u. m	Unit	price €
	Pin for BKDF for riveting at center caps, will be used when a journal offset of a pin is required or as a double guide channel version				
	Pin for BKDF For clenching at the central end cap. Necessary in case of pin offset or as double guide channel	891200300	1	pce	



SAFETY PLATES MADE OF ALUMINIUM

PINE TREE CLIP AND INTAKE FOR INSECT-REPELLING SYSTEM

ALUKON

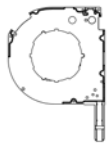
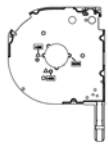
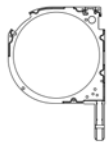

	Product description	article no.	p.u. m	Unit	price €
	Safety plate Universal steel 40 mm shaft				
	AWB-I 138 Universal, steel	091380010	10	pce	
	AWB-I 150 Universal, steel	091500010	10	pce	
	AWB-I 165 Universal, steel	091650010	10	pce	
	AWB-I 180 Universal, steel	091800010	10	pce	
	Safety plate steel 60 mm shaft				
	AWB-I 138 Universal, steel	091380011	10	pce	
	AWB-I 150 Universal, steel	091500011	10	pce	
	AWB-I 165 Universal, steel	091650011	10	pce	
	AWB-I 180 Universal, steel	091800011	10	pce	
	Safety plate for built-in unit Universal aluminium 40 mm shaft				
	AWB-PT-I 138 Universal, aluminium	091380510	10	pce	
	AWB-PT-I 150 Universal, aluminium	091500510	10	pce	
	AWB-PT-I 165 Universal, aluminium	091650510	10	pce	
	AWB-PT-I 180 Universal, aluminium	091800510	10	pce	
	safety plate for built-in unit Universal aluminium 60 mm shaft				
	AWB-PT-I 138 Universal, aluminium	091380511	10	pce	
	AWB-PT-I 150 Universal, aluminium	091500511	10	pce	
	AWB-PT-I 165 Universal, aluminium	091650511	10	pce	
	AWB-PT-I 180 Universal, aluminium	091800511	10	pce	
	Intake for insect-repelling system				
	for end cap 138	316021600	25	pair	
	for end cap 150 - 205	316021700	25	pair	
	Intake for insect-repelling system double guide channel				
	for end cap 138	316021800	20	pce	
	for end cap 150 - 205	316021900	20	pce	



Pine Tree Clip see page 4.8

	Product description	article no.	p.u. m	Unit	price €
	punched out on the left side for external pulley AGS*	239920200		pce	
	punched out on the right side for external pulley AGS*	239920300		pce	
	punched out and edged for double shaft bolt (60 mm shaft) Ø 40 mm	239920500		pce	
	punched out and edged for intermediate PVC bearing (40 mm shaft) Ø 72 mm	239920600		pce	
	punched out on the left side and edged for steel pulley SGS	239920900		pce	
	punched out on the right side and edged for steel pulley SGS	239921000		pce	
	without plug-in feet	239921200		pce	

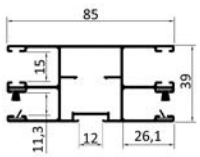
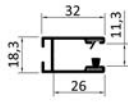
*in case of punch out for AGS and box size 165, it is necessary to indicate which box type is used and whether insect repelling system is required.

EXTRUDED GUIDE CHANNELS FOR INTEGRATED INSECT REPELLING SYSTEM

	Product description	article no.	p.u. m	Unit	price €	
	Guide channel A 20-CR, with diagonal and thick brush					
	mill-finished (without insert)	319015100	30	m		
	standard colours	3190151..	30	m		
	03 nougat brown 08 silver 21 brown SF	26 white 9016 mat 82 charcoal				
	silver anodized EV 1	319015141	30	m		
	bronze anodized BC 4..51, C 33 ..55	3190151..	30	m		
	RAL	319015199	30	m		
	golden oak (laminated) Renolit-No 2178 001	319015180	30	m		
	Guide channel DF A 20-CR, with diagonal and thick brush					
	mill-finished	122015000	30	m		
	standard colours	1220150..	30	m		
	silver anodized EV 1	122015041	30	m		
	bronze Anodized BC 4 ..51, C 33 ..55	1220150..	30	m		
	RAL	122015099	30	m		
	Guide channel A 22, with diagonal and thick brush					
	mill-finished	734101800	60	m		
	white	7341018..	60	m		
	RAL	734101899	60	m		
		739912800		m		
	Mounting plate A 22					
	138 left, galvanized incl. stopper	316030100	5	pce		
	138 right, galvanized incl. stopper	316030200	5	pce		
	150 left, galvanized incl. stopper	316030300	5	pce		
	150 right, galvanized incl. stopper	316030400	5	pce		
	165 left, galvanized incl. stopper	316030500	5	pce		
	165 right, galvanized incl. stopper	316030600	5	pce		
	180 left, galvanized incl. stopper	316030700	5	pce		
	180 right, galvanized incl. stopper	316030800	5	pce		
	205 left, galvanized incl. stopper	316030900	5	pce		
205 right, galvanized incl. stopper	316031000	5	pce			

	Product description	article no.	p.u. m	Unit	price €
	Guide channel end part for A 20				
	galvanized, left	119250600	10	pce	
	galvanized, right	119250700	10	pce	
	standard colours, left	1192506..	10	pce	
	standard colours, right	1192507..	10	pce	
	09 bronze coated	25 bronze C33 coated			
	26 white 9016 mat				
	RAL, left	119250699	10	pce	
RAL, right	119250799	10	pce		
	Guide channel end part for A 20 with round cover FAR-BC				
	galvanized, left	119251300	10	pce	
	galvanized, right	119251400	10	pce	
	standard colours, left	1192513..	10	pce	
	standard colours, right	1192514..	10	pce	
	03 nougat brown	21 brown SF			
	08 silver	25 bronze C33 coated			
	09 bronze coated	26 white 9016 mat			
RAL, left	119251399	10	pce		
RAL, right	119251499	10	pce		
	Inlay guide channel end part for 53 mm guide channels				
	V2A stainless steel	119270100	100	pce	



EXTRA CHARGES FOR GUIDE CHANNELS



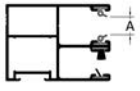
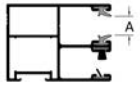
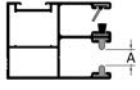
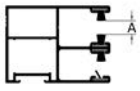

WITH THREADED PVC- AND BRUSH INSERTS

ALUKON

	Product description	article no.	p.u. m	Unit	price €
	2 x PVC insert A = 9,6 mm				
	PVC insert (A = 9,6 mm)	319911000		m	
	Extra charge standard insert (DF)	129911000		m	
	2 x thin insert A = 10,4 mm				
	2 x insert for M 521 A = 14,0 mm				
	Polyethylene insert	319910400		m	
	Insert for M 521 (A = 14,0 mm)	319910900		m	
	Extra charge insert Polyethylene (DF)	129910400		m	
	2 x T-insert A = 7,2 mm				
	2 x s_onro®-insert A = 8,8 - 9,3 mm				
	Extra charge T-shaped insert	319911500		m	
	Extra charge s_onro insert	319911400		m	
	Extra charge T-shaped insert (DF)	129911500		m	
	2 x thick brush A = 7,5 mm				
	2 x solid brush A = 5,5 mm				
	1 x solid brush, 1 x thick brush A = 6,5 mm				
	thick brush	319912100		m	
	Solid brush (A = 5,5 mm)	319910200		m	
	solid brush and thick brush (A = 6,5 mm)	319910300		m	
	single-sided protection film	319910700		m	
	double-sided protection film	319910800		m	
	Extra charge thick brush (DF)	129912100		m	
	Extra charge solid brush (DF)	129910200		m	
	Extra charge solid brush and thick brush (DF)	129910300		m	
Extra charge protection film single-sided (DF)	129910700		m		
Extra charge protection film two-sided (DF)	129910800		m		

Please note our "Recommended use of PVC and brush inserts".





	Product description	article no.	p.u. m	Unit	price €
	PVC insert (double barralled)				
	Standard version for mini curtain M 317, M 328-N, KM 317	119010000	360	m	
	Polyethylene insert (double barralled)				
	Special version Excellent stabilization of the roller shutter curtain thanks to two plies. The insert is highly resistant to temperature changes without deforming. thin for roller curtain MY 442 / MY 448	119060000	300	m	
	Polyethylene insert for profile M 521				
	Special version In combination with this insert, the foamed aluminium profile M 521 for new buildings can also be used for 22 mm guide channels. applicable for M 521, M 528 and KM 521	119120100	1000	m	
	Extra charge for inserts in small quantities (per piece)				
	Extra charge for brushes and inserts in small quantities (per piece)	890000200		pce	





	Product description	article no.	p.u. m	Unit	price €
	Brush inserts				
	Brush inserts instead of PVC inserts helps the curtain to run more quietly.				
	thin A = 4,25 mm / B = 3,25 mm	119030090	475	m	
	thick brush A = 6,25 mm / B = 5,25 mm	119040090	275	m	
	Solid brush				
	The PVC mid position of the solid brush stabilizes the shutter better than a normal brush insert.	119050090	450	m	
	Filling brush				
	for blackout effect, brush height 8mm	119090090	250	m	
	Diagonal brush 7 mm				
	for A 20 / A 22 / A 23	319151000	1000	m	
	Extra charge for inserts in small quantities (per piece)				
	Extra charge for brushes and inserts in small quantities (per piece)	890000200		pce	

INSECT SCREEN ON Ø 20 MM GROOVED SHAFT

INSECT REPELLING SPRING MECHANICS WITH BRAKE

ALUKON

	Product description	article no.	p.u. m	Unit	price €
	Insect screen				
	20 mm grooved shaft, length 600 cm, with glued fibreglass mesh. A PVC profile is fixed on the mesh to be insert into the end slat SLI.2				
	insect screen black 600 x 130 cm	319151590	6	m	
	insect screen black 600 x 170 cm	319151390	6	m	
	insect screen black 600 x 250 cm	319151490	6	m	
	insect screen grey 600 x 130 cm	319151500	6	m	
	insect screen grey 600 x 170 cm	319151300	6	m	
	insect screen grey 600 x 250 cm	319151400	6	m	
	Spring mechanics 3.0 including brake for elements exceeding 69,0 cm width including handles				
	set of 1	316011100	1	pce	
	set of 25	316011200	1	pce	
	Spring mechanics 3.0 without brake for element width 42,0 - 68,9 cm including handles				
	set of 1	316011300	1	pce	
	set of 25	316011400	1	pce	
	ALUKON insect stop as additional insulation inside the box against insects, can be retrofitted				
	15 mm self-adhesive	319150200	100	m	





	Product description	article no.	p.u. m	Unit	price €	
	End slat SLI.2					
	mill-finished	319051000	60	m		
	standard colours	3190510..	60	m		
	03 nougat brown 08 silver 21 brown SF	26 white 9016 mat 82 charcoal				
	silver anodized EV 1	319051041	60	m		
	bronze anodized BC 4	3190510..	60	m		
	RAL	319051099	60	m		
	golden oak (laminated) Renolit-No 2178 001	319051080	60	m		
	Telescope profile for SLI.2					
	mill-finished	319052000	60	m		
	standard colours	3190520..	60	m		
	21 brown SF	26 white 9016 mat				
	silver anodized EV 1	319052041	60	m		
	bronze anodized BC 4	3190520..	60	m		
	RAL	319052099	6	m		
	Brush for SLI.2 "rear" to insulate towards the window					
	12,5 mm	300135790	150	m		
	Brush for SLI.2 "below" optionally to insulate towards the window sill 20 mm or related to telescope profile 8mm					
	8,0 mm (A = 8,00 mm B = 7,20 mm)	300135690	275	m		
	20 mm	319150790	125	m		
	Cord with tassel, removable					
	black, 40 cm	319211000	100	pce		
Extra charge for inserts in small quantities (per piece)						
Extra charge for brushes and inserts in small quantities (per piece)		890000200		pce		

Please note: There is no stock service in bronze anodized BC 4 and C 33. A certain delivery time should be accepted. Brown SF is generally used as basic colour for golden oak lamination.

ACCESSORIES FOR EXTRUDED END SLAT FOR INSECT REPELLING SYSTEMS

ALUKON

INSECT REPELLING END SLAT

	Product description	article no.	p.u. m	Unit	price €
	Easy-Click.3 Set with additional parts				
	set of 1	319152502	1	pce	
	set of 25	319152602	1	pce	
	AL-IS.2 stop for SLI.2				
	black	300631500	25	pce	
	Handles for SL-I.2 black				
	black	316021300	2	pce	
	Spring bolt for SLI.2				
	137 mm, black	319211500	10	pair	
	197 mm, black	319211800	10	pair	
	drilling template to fix the spring bolt in guide channel A 20				
		319212100	1	pce	

14 INSEKTENSCHUTZPROGRAMM

AL-IS

Moustiquaires AL-IS





ALUKON Insect repelling system AL-IS

Program ochrony proti hmyzu AL-IS

System antyinsektowy AL-IS

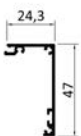
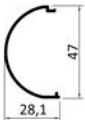
ALUKON insektenwerende systemen AL-IS

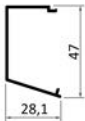



AL-IS Szúnyoghálóprogram

	Product description	article no.	p.u. m	Unit	price €
	AL-IS.2 upper part IR				
	mill-finished	300601000	36	m	
	standard colours	3006010..	36	m	
	21 brown SF	26 white 9016 mat			
	RAL	300601099	36	m	
	AL-IS.2 lower part IR round				
	mill-finished	300603000	36	m	
	standard colours	3006030..	36	m	
	21 brown SF	26 white 9016 mat			
	RAL	300603099	36	m	
	AL-IS.2 end caps IR round				
	white	300630400	25	pair	
	black	300630500	25	pair	
	AL-IS.2 lower part IR bevelled				
	mill-finished	300602000	36	m	
	standard colours	3006020..	36	m	
	21 brown SF	26 white 9016 mat			
	RAL	300602099	36	m	
	AL-IS.2 end caps IR bevelled				
	white	300630100	25	pair	
	black	300630200	25	pair	
	AL-IS.2 tensioning part for IR for shaft 20 mm				
	black	300630300	50	pce	

INSECT SCREEN ON Ø 20 MM GROOVED SHAFT

INSECT REPELLING SPRING MECHANICS WITH BRAKE





ALUKON





	Product description	article no.	p.u. m	Unit	price €
	Insect screen				
	20 mm grooved shaft, length 600 cm, with glued fibreglass mesh. A PVC profile is fixed on the mesh to be insert into the end slat SLI.2				
	insect screen black 600 x 130 cm	319151590	6	m	
	insect screen black 600 x 170 cm	319151390	6	m	
	insect screen black 600 x 250 cm	319151490	6	m	
	insect screen grey 600 x 130 cm	319151500	6	m	
	insect screen grey 600 x 170 cm	319151300	6	m	
	insect screen grey 600 x 250 cm	319151400	6	m	
	Spring mechanics 3.0 including brake for elements exceeding 69,0 cm width including handles				
	set of 1	316011100	1	pce	
	set of 25	316011200	1	pce	
	Spring mechanics 3.0 without brake for element width 42,0 - 68,9 cm including handles				
	set of 1	316011300	1	pce	
	set of 25	316011400	1	pce	
	AL-IS.2 Handle 1707/85				
		300632100	1	pce	

ACCESSORIES FOR EXTRUDED END SLAT FOR INSECT REPELLING SYSTEMS

ALUKON

INSECT REPELLING END SLAT

	Product description	article no.	p.u. m	Unit	price €
	Easy-Click.3 Set with additional parts				
	set of 1	319152502	1	pce	
	set of 25	319152602	1	pce	
	AL-IS.2 stop for SLI.2				
	black	300631500	25	pce	
	Handles for SL-I.2 black				
	black	316021300	2	pce	
	Spring bolt for SLI.2				
	137 mm, black	319211500	10	pair	
	197 mm, black	319211800	10	pair	
	drilling template for spring bolt				
		319212200	1	pce	

	Product description	article no.	p.u. m	Unit	price €
	AL-IS.2 brush 4,0 mm (A = 4,00 mm B = 3,20 mm)	300135590	700	m	
	AL-IS.2 handle lug for SP, for screwing transparent	300138200	100	pce	
	AL-IS.2 handle lug for SP, for rolling in transparent	300138300	100	pce	
		300140100	20	pce	

FIXATION FOR AL-IS TENSIONING FRAME SP-V

ALUKON

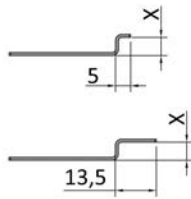

AL-IS.2 hook

	Fold depth Standard / mit Federhaken	Part no. long	Part no. short	unit	Price in €/ Stück
x = 0 mm	6 / 11	300142000	300145000	20 pce	
x = 4 mm	10 / 15	300142004	300145004		
x = 6 mm	12 / 17	300142006	300145006		
x = 8 mm	14 / 19	300142008	300145008		
x = 9 mm	15 / 20	300142009	300145009		
x = 10 mm	16 / 21	300142010	300145010		
x = 11 mm	17 / 22	300142011	300145011		
x = 12 mm	18 / 23	300142012	300145012		
x = 14 mm	20 / 25	300142014	300145014		
x = 16 mm	22 / 27	300142016	300145016		
x = 18 mm	24 / 29	300142018	300145018		
x = 19 mm	25 / 30	300142019	300145019		
x = 20 mm	26 / 31	300142020	300145020		
x = 21 mm	27 / 32	300142021	300145021		
x = 22 mm	28 / 33	300142022	300145022		
x = 24 mm	30 / 35	300142024	300145024		
x = 26 mm	32 / 37	300142026	300145026		
x = 28 mm	34 / 39	300142028	300145028		
x = 30 mm	36 / 41	300142030	300145030		
x = 32 mm	38 / 43	300142032	300145032		
x = 34 mm	40 / 45	300142034	300145034		
x = 36 mm	42 / 47	300142036	300145036		
x = 38 mm	44 / 49	300142038	300145038		
x = 40 mm	46 / 51	300142040	300145040		



AL-IS.2 Carriage for mounting the hooks and grip tabs

	Product description	article no.	p.u. m	Unit	price €
	AL-IS.2 carriage for SP-V, 1,0 mm				
	V2A stainless steel	300141200	50	pce	

COMPONENTS FOR AL-IS TENSIONING FRAME

ALUKON

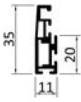
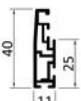
SP-B 35 MM AND SP-B 40 MM

	Product description	article no.	p.u. m	Unit	price €
	AL-IS.3 frame profile SP-B 35mm				
	mill-finished	300102300	36	m	
	standard colours	3001023..	36	m	
	21 brown SF	26 white 9016 mat			
	RAL	300102399	36	m	
	AL-IS.3 frame profile SP-B 40mm				
	mill-finished	300102400	36	m	
	standard colours	3001024..	36	m	
	21 brown SF	26 white 9016 mat			
	RAL	300102499	36	m	
	AL-IS.3 corner connector extruded for SP, RT and ST				
		300130500	150	pce	
	AL-IS.2 brushes				
	4,0 mm (A = 4,00 mm B = 3,20 mm)	300135590	700	m	
	8,0 mm (A = 8,00 mm B = 7,20 mm)	300135690	275	m	
	Extra charge for inserts in small quantities (per piece)				
	Extra charge for brushes and inserts in small quantities (per piece)	890000200		pce	

FIXATION FOR AL-IS TENSIONING FRAME

ALUKON

SP-B 35 MM AND SP-B 40 MM

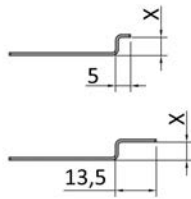

AL-IS.2 hook







	Fold depth Standard mit 4 mm / 8 mm Bürste	Fold depth m. Federhaken mit 4 mm / with 8 mm brush	Part no. long	Part no. short	unit	Price in € / Stück
x = 0 mm	-	-	300142000	300145000	20 pce	
x = 4 mm	-	- / 5	300142004	300145004		
x = 6 mm	-	8 / 7	300142006	300145006		
x = 8 mm	5 / 4	10 / 9	300142008	300145008		
x = 9 mm	6 / 5	11 / 10	300142009	300145009		
x = 10 mm	7 / 6	12 / 11	300142010	300145010		
x = 11 mm	8 / 7	13 / 12	300142011	300145011		
x = 12 mm	9 / 8	14 / 13	300142012	300145012		
x = 14 mm	11 / 10	16 / 15	300142014	300145014		
x = 16 mm	13 / 12	18 / 17	300142016	300145016		
x = 18 mm	15 / 14	20 / 19	300142018	300145018		
x = 19 mm	16 / 15	21 / 20	300142019	300145019		
x = 20 mm	17 / 16	22 / 21	300142020	300145020		
x = 21 mm	18 / 17	23 / 22	300142021	300145021		
x = 22 mm	19 / 18	24 / 23	300142022	300145022		
x = 24 mm	21 / 20	26 / 25	300142024	300145024		
x = 26 mm	23 / 22	28 / 27	300142026	300145026		
x = 28 mm	25 / 26	30 / 29	300142028	300145028		
x = 30 mm	27 / 28	32 / 31	300142030	300145030		
x = 32 mm	29 / 30	34 / 33	300142032	300145032		
x = 34 mm	31 / 32	36 / 35	300142034	300145034		
x = 36 mm	33 / 32	38 / 37	300142036	300145036		
x = 38 mm	35 / 34	40 / 39	300142038	300145038		
x = 40 mm	37 / 36	42 / 41	300142040	300145040		

AL-IS.2 Carriage for mounting the hooks and grip tabs

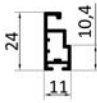
	Product description	article no.	p.u. m	Unit	price €
	AL-IS.2 carriage for SP-V, 1,0 mm				
	V2A stainless steel	300141200	50	pce	

COMPONENTS FOR AL-IS TENSIONING FRAME SP-B 24 MM

ALUKON

	Product description	article no.	p.u. m	Unit	price €
	AL-IS.2 frame profile SP-B 24mm				
	mill-finished	300102200	36	m	
	standard colours	3001022..	36	m	
	21 brown SF	26 white 9016 mat			
	RAL	300102299	36	m	
	AL-IS.3 corner connector extruded for SP, RT and ST				
		300130500	150	pce	
	AL-IS.2 brushes				
	8,0 mm (A = 8,00 mm B = 7,20 mm)	300135690	275	m	
	AL-IS.2 stabilizing profile				
	mill-finished	300103000	36	m	
	standard colours	3001030..	36	m	
	21 brown SF	26 white 9016 mat			
	RAL	300103099	36	m	
	AL-IS.2 connector for SP stabilizing profile				
	black	300130200	50	pce	
	AL-IS.2 handle lug for SP, for rolling in				
	transparent	300138300	100	pce	
	Extra charge for inserts in small quantities (per piece)				
	Extra charge for brushes and inserts in small quantities (per piece)	890000200		pce	

FIXATION FOR AL-IS TENSIONING FRAME SP-B 24 MM

ALUKON

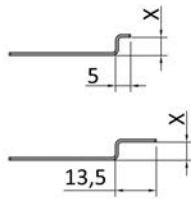

AL-IS.2 hook





	Fold depth	Part no. long	Part no. short	unit	Price in € / Stück
x = 0 mm	-	300142000	300145000	20 pce	
x = 4 mm	-	300142004	300145004		
x = 6 mm	4	300142006	300145006		
x = 8 mm	6	300142008	300145008		
x = 9 mm	7	300142009	300145009		
x = 10 mm	8	300142010	300145010		
x = 11 mm	9	300142011	300145011		
x = 12 mm	10	300142012	300145012		
x = 14 mm	12	300142014	300145014		
x = 16 mm	14	300142016	300145016		
x = 18 mm	16	300142018	300145018		
x = 19 mm	17	300142019	300145019		
x = 20 mm	18	300142020	300145020		
x = 21 mm	19	300142021	300145021		
x = 22 mm	20	300142022	300145022		
x = 24 mm	22	300142024	300145024		
x = 26 mm	24	300142026	300145026		
x = 28 mm	26	300142028	300145028		
x = 30 mm	28	300142030	300145030		
x = 32 mm	30	300142032	300145032		
x = 34 mm	32	300142034	300145034		
x = 36 mm	34	300142036	300145036		
x = 38 mm	36	300142038	300145038		
x = 40 mm	38	300142040	300145040		



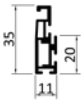
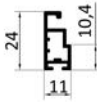

AL-IS.2 mounting bracket for SP-B



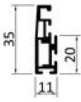

	Product description	article no.	p.u. m	Unit	price €
	white	300151500	50	pair	
	Dark brown	300151600	50	pair	

COMPONENTS FOR AL-IS TENSIONING FRAME SP-F

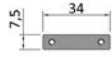
ALUKON

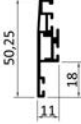
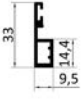

	Product description	article no.	p.u. m	Unit	price €
	AL-IS frame profile SP-F 35 mm				
	mil finished	300102500	36	m	
	standard colours	3001025..	36	m	
	21 brown SF	26 white 9016 mat			
	RAL	300102599	36	m	
	AL-IS.2 frame profile SP-B 24mm				
	mill-finished	300102200	36	m	
	standard colours	3001022..	36	m	
	21 brown SF	26 white 9016 mat			
	RAL	300102299	36	m	
	AL-IS.3 corner connector extruded for SP, RT and ST				
		300130500	150	pce	
	AL-IS.2 spring pin incl. spring and sleeve				
	for SP-B 35 mm	300151100	40	pce	
	for SP-B 24 mm	300151200	40	pce	
	AL-IS.2 swivel joint for spring pin				
		300151300	50	pce	
	AL-IS.2 lever for spring pin				
	black	300151400	50	pce	

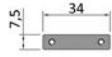
	Product description	article no.	p.u. m	Unit	price €
	AL-IS.3 frame profile SP-B 35mm wing frame				
	mill-finished	300102300	36	m	
	standard colours	3001023..	36	m	
	21 brown SF	26 white 9016 mat			
	RAL	300102399	36	m	
	AL-IS.2 frame profile RT-B				
	mill-finished	300201000	36	m	
	standard colours	3002010..	36	m	
	21 brown SF	26 white 9016 mat			
	RAL	300201099	36	m	
	AL-IS.2 hinge RT-B with WSR (shaft circlip)				
	silver anodized EV 1	300241241	30	pce	
	AL-IS.2 hinge RT-B 3-parts, assembled				
	silver anodized EV 1	300241441	30	pce	
	AL-IS.2 spring hinge RT-B, assembled				
	silver anodized EV 1	300241341	30	pce	
	AL-IS.2 carriage 1,0 mm				
	V2A stainless steel	300141200	50	pce	

	Product description	article no.	p.u. m	Unit	price €
	AL-IS.3 frame profile SP-V 18mm wing profile				
	mill-finished	300101300	36	m	
	standard colours	3001013..	36	m	
	21 brown SF	26 white 9016 mat			
	RAL	300101399	36	m	
	AL-IS.2 frame profile RT-V				
	mill-finished	300201100	36	m	
	standard colours	3002011..	36	m	
	21 brown SF	26 white 9016 mat			
	RAL	300201199	36	m	
	AL-IS.2 hinge RT-V with WSR (shaft circlip)				
	silver anodized EV 1	300242241	30	pce	
	AL-IS.2 hinge RT-V 3-parts, assembled				
	silver anodized EV 1	300242441	30	pce	
	AL-IS.2 spring hinge RT-V, assembled				
	silver anodized EV 1	300242341	30	pce	
	AL-IS.2 carriage 1,0 mm				
	V2A stainless steel	300141200	50	pce	



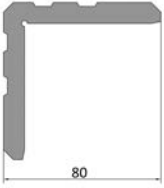
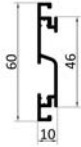
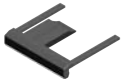
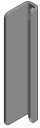
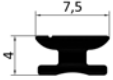

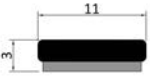
COMPONENTS FOR AL-IS FRAME DOOR RT-B AND RT-V





ALUKON

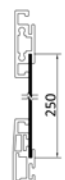
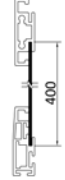



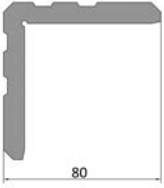
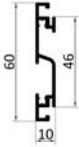
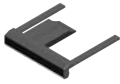

	Product description	article no.	p.u. m	Unit	price €
	AL-IS.3 corner connector extruded for SP, RT and ST	300130500	150	pce	
	AL-IS.2 handle RT				
	mill-finished	300202000	36	m	
	standard colours	3002020..	36	m	
	21 brown SF	26 white 9016 mat			
	RAL	300202099	36	m	
	AL-IS.2 connector for RT handle				
	black	300230200	25	pair	
	AL-IS.3 handle for framed door				
	mil finished	300232500	1	pce	
	standard colours	3002325..	1	pce	
	21 brown SF	26 white 9016 mat			
	RAL	300232599	1	pce	
	AL-IS.2 magnetic tape for RT to insert	300235100	100	m	
	AL-IS.2 adhesive magnetic tape for RT with adhesive foam	300235200	50	m	
	AL-IS.2 magnetic ledge 11 x 3 mm, V2A stainless steel including 3 mm adhesive tape	300235500	1	pce	
	Length 245 cm				

COMPONENTS FOR AL-IS FRAME DOOR RT-B AND RT-V

ALUKON

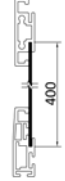

	Product description	article no.	p.u. m	Unit	price €
	AL-IS.2 brushes				
	4,0 mm (A = 4,00 mm B = 3,20 mm)	300135590	700	m	
	AL-IS.2 L-angle for brush				
	mill-finished	300206000	36	m	
	standard colours	3002060..	36	m	
	21 brown SF	26 white 9016 mat			
	RAL	300206099	36	m	
	AL-IS.2 kick plate for RT 1300 x 100 x 1,0 mm				
	mill-finished	300203100	5	pce	
	standard colours	3002031..	5	pce	
	21 brown SF	26 white 9016 mat			
	EV1	300203141	5	pce	
	RAL	300203199	5	pce	
	AL-IS.2 kick plate, 1300 x 250 x 0,9 mm				
	mill-finished	300203300	5	pce	
	standard colours	3002033..	5	pce	
	21 brown SF	26 white 9016 mat			
	RAL	300203399	5	pce	
	AL-IS.2 kick plate, 1300 x 400 x 0,9 mm				
	mill-finished	300203200	5	pce	
	standard colours	3002032..	5	pce	
	21 brown SF	26 white 9016 mat			
	RAL	300203299	5	pce	
	AL-IS.2 stabilizing profile				
	mill-finished	300103000	36	m	
	standard colours	3001030..	36	m	
	21 brown SF	26 white 9016 mat			
	RAL	300103099	36	m	
	AL-IS.2 connector for stabilizing profile				
	black	300130200	50	pce	

	Product description	article no.	p.u. m	Unit	price €
	AL-IS.3 corner connector extruded for SP, RT and ST				
		300130500	150	pce	
	AL-IS.2 handle RT				
	mill-finished	300202000	36	m	
	standard colours	3002020..	36	m	
	21 brown SF	26 white 9016 mat			
	RAL	300202099	36	m	
	AL-IS.2 connector for RT handle				
	black	300230200	25	pair	
	AL-IS.2 block magnet for swinging door, 8 x 5 x 100				
		300235900	35	pce	
	Thread pin for magnetic block				
	M4 x 4	300235810	100	pce	
	AL-IS.2 mounting f. block magnet				
		300235800	35	pce	
	AL-IS.2 corner pieces for swinging door				
	black	300230300	20	pce	

	Product description	article no.	p.u. m	Unit	price €
	AL-IS.2 brushes				
	4,0 mm (A = 4,00 mm B = 3,20 mm)	300135590	700	m	
	Extra charge for inserts in small quantities (per piece)				
	Extra charge for brushes and inserts in small quantities (per piece)	890000200		pce	
	AL-IS.2 L-angle for brush				
	mill-finished	300206000	36	m	
	standard colours	3002060..	36	m	
	21 brown SF	26 white 9016 mat			
	RAL	300206099	36	m	
	AL-IS.2 kick plate for RT 1300 x 100 x 1,0 mm				
	mill-finished	300203100	5	pce	
	standard colours	3002031..	5	pce	
	21 brown SF	26 white 9016 mat			
	RAL	300203199	5	pce	
	AL-IS.2 kick plate, 1300 x 250 x 0,9 mm				
	mill-finished	300203300	5	pce	
	standard colours	3002033..	5	pce	
	21 brown SF	26 white 9016 mat			
	RAL	300203399	5	pce	
	AL-IS.2 kick plate, 1300 x 400 x 0,9 mm				
	mill-finished	300203200	5	pce	
	standard colours	3002032..	5	pce	
	21 brown SF	26 white 9016 mat			
	RAL	300203299	5	pce	
	AL-IS.2 stabilizing profile				
	mill-finished	300103000	36	m	
	standard colours	3001030..	36	m	
	21 brown SF	26 white 9016 mat			
	RAL	300103099	36	m	
	AL-IS.2 connector for stabilizing profile				
	black	300130200	50	pce	



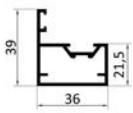
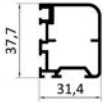

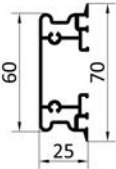
COMPONENTS FOR AL-IS FRAME DOOR RT 50

ALUKON

	Product description	article no.	p.u. m	Unit	price €
	AL-IS frame profile RT 50				
	mill-finished	310201500	6	m	
	standard colours	3102015..	6	m	
	21 brown SF	26 white 9016 mat			
	RAL	310201599	6	m	
	AL-IS wing profile RT 50				
	mill-finished	310204500	6	m	
	standard colours	3102045..	6	m	
	21 brown SF	26 white 9016 mat			
	RAL	310204599	6	m	
	AL-IS locking profile RT 50				
	mill-finished	310205500	6	m	
	standard colours	3102055..	6	m	
	21 brown SF	26 white 9016 mat			
	RAL	310205599	6	m	
	AL-IS handle for RT 50				
	mill-finished	310202500	6	m	
	standard colours	3102025..	6	m	
	21 brown SF	26 white 9016 mat			
	RAL	310202599	6	m	

COMPONENTS FOR AL-IS FRAME DOOR RT 50

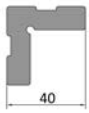



ALUKON

	Product description	article no.	p.u. m	Unit	price €
	AL-IS hinge RT 50 with bolts black	310231500	2	pce	
	AL-IS spring hinge RT 50 black	310231600	1	pce	
	AL-IS corner connection for RT 50 24 mm	310230500	8	pce	
	AL-IS magnetic band for RT 50 black	310235500	250	m	
	AL-IS.2 brushes 12,5 mm	300135790	150	m	
	Extra charge for inserts in small quantities (per piece)				
	Extra charge for brushes and inserts in small quantities (per piece)	890000200		pce	

COMPONENTS FOR AL-IS SLIDING DOOR ST

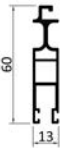
BEARING AT THE TOP







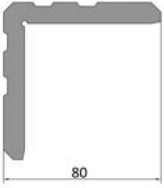

ALUKON

	Product description	article no.	p.u. m	Unit	price €
	AL-IS.3 wing profile ST				
	mill-finished	300301600	36	m	
	standard colours	3003016..	36	m	
	21 brown SF	26 white 9016 mat			
	RAL	300301699	36	m	
	AL-IS.2 guide "U" for ST				
	mill-finished	300302100	36	m	
	standard colours	3003021..	36	m	
	21 brown SF	26 white 9016 mat			
	RAL	300302199	36	m	
	AL-IS.2 bottom track for ST				
	mill-finished	300302500	36	m	
	standard colours	3003025..	36	m	
	21 brown SF	26 white 9016 mat			
	RAL	300302599	36	m	
	AL-IS.3 guide "Z" for ST				
	mill-finished	300302300	36	m	
	standard colours	3003023..	36	m	
	21 brown SF	26 white 9016 mat			
	RAL	300302399	36	m	
	AL-IS.2 bottom rail U for ST				
	mill-finished	300302600	36	m	
	standard colours	3003026..	36	m	
	21 brown SF	26 white 9016 mat			
	RAL	300302699	36	m	

COMPONENTS FOR AL-IS SLIDING DOOR ST

BEARING AT THE TOP





ALUKON

	Product description	article no.	p.u. m	Unit	price €
	AL-IS.3 corner connector extruded for SP, RT and ST	300130500	150	pce	
	AL-IS trolley + quick-slide for ST without frame	300332000	20	pce	
	AL-IS trolley + quick-slide for ST with frame	300332100	20	pce	
	AL-IS.2 grub screw M4x12mm	300330200	100	pce	
	AL-IS.2 damping for ST	300331200	10	pce	
	AL-IS.2 damping stop ST	300331300	10	pce	
	AL-IS.2 stopper for ST				
	grey	300331400	20	pce	
	AL-IS unlocking tool				
	blackfor ST trolley + Quickslide	300332900	100	pce	

COMPONENTS FOR AL-IS SLIDING DOOR ST

BEARING AT THE TOP



ALUKON

	Product description	article no.	p.u. m	Unit	price €
	AL-IS.2 brush for ST				
	4,0 mm (A = 4,00 mm B = 3,20 mm)	300135590	700	m	
	12,5 mm	300135790	150	m	
Extra charge for inserts in small quantities (per piece)					
Extra charge for brushes and inserts in small quantities (per piece)		890000200		pce	
	AL-IS.3 frame profile ST				
	mill-finished	300301100	36	m	
	standard colours	3003011..	36	m	
	21 brown SF	26 white 9016 mat			
	RAL	300301199	36	m	
	AL-IS.2 corner connector V2 for ST-frame profile				
	including grub screw	300330300	20	pce	
	AL-IS.3 sealing profile ST				
	black	300335200	10	m	

COMPONENTS FOR AL-IS SLIDING DOOR ST

BEARING AT THE BOTTOM

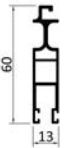



ALUKON

	Product description	article no.	p.u. m	Unit	price €
	AL-IS.3 wing profile ST				
	mill-finished	300301600	36	m	
	standard colours	3003016..	36	m	
	21 brown SF	26 white 9016 mat			
	RAL	300301699	36	m	
	AL-IS.3 corner connector extruded for SP, RT and ST				
		300130500	150	pce	
	AL-IS carriage (below) + locking device (above)				
	5 sets (incl. 2 pcs.)	310331100	5	pce	

COMPONENTS FOR AL-IS SLIDING DOOR ST



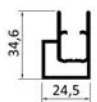

BEARING AT THE BOTTOM





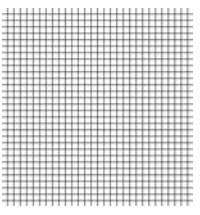
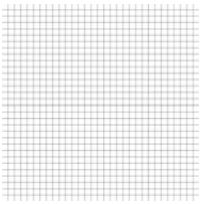

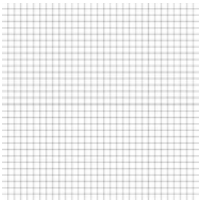
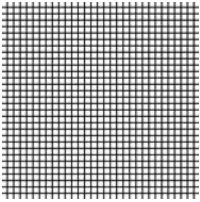
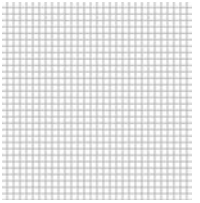
ALUKON

	Product description	article no.	p.u. m	Unit	price €
	AL-IS.3 guide "Z" for ST				
	mill-finished	300302300	36	m	
	standard colours	3003023..	36	m	
	21 brown SF	26 white 9016 mat			
	RAL	300302399	36	m	
	AL-IS.2 bottom rail U for ST				
	mill-finished	300302600	36	m	
	standard colours	3003026..	36	m	
	21 brown SF	26 white 9016 mat			
	RAL	300302699	36	m	
	AL-IS.3 frame profile ST				
	mill-finished	300301100	36	m	
	standard colours	3003011..	36	m	
	21 brown SF	26 white 9016 mat			
	RAL	300301199	36	m	
	AL-IS.2 corner connector V2 for ST-frame profile				
	including grub screw	300330300	20	pce	

ACCESSORIES FOR TENSIONING FRAME, FRAME DOOR AND SLIDING DOOR

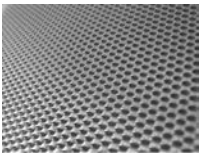

ALUKON

	Product description	article no.	p.u. m	Unit	price €
	AL-IS.2 gauze for SP, RT, ST				
	140 cm, charcoal	300136100	100	m	
	180 cm, charcoal	300136200	100	m	
	240 cm, charcoal	300136300	100	m	
	120 cm, black	300136400	100	m	
	180 cm, black	300136500	100	m	
	AL-IS.2 transparent gauze				
	140 cm, black	300137000	50	m	
	260 cm, black	300137100	90	m	
	AL-IS.2 insert PVC for SP, RT 11, ST, 5,1mm				
	grey	300135300	700	m	
	black	300135400	700	m	
	AL-IS.2 highly transparent and pollen prevention gauze				
	140 cm, black	300136800	30	m	
	AL-IS.2 gauze f. RT, tear-resistant				
	tear-resistant, width = 122 cm, grey	300236100	30,5	m	
	tear-resistant, width = 122 cm, black	300236200	30,5	m	
	AL-IS.2 stainless steel grill (not available as pre-cut part)				
	width = 120 cm	300136900	30,5	m	
	AL-IS.2 insert for RT, 4,7mm				
	grey	300235300	700	m	
	black	300235400	700	m	
	AL-IS.2 insert protection profile for tensioning frame, length: 3m				
	black	300135100	3	m	

	Product description	article no.	p.u. m	Unit	price €
	AL-IS.2 frame profile LSA, silver anodized EV 1				
	silver anodized EV 1	300501041	36	m	
	AL-IS.2 corner connector LSA, to clamp				
		300530100	40	pce	
	Expanded metal grill				
	Stainless steel 1.4301 plate size 125 x 250 cm	300536300	10	pce	
	AL-IS.2 angle brush for LSA				
	black	300535100	500	m	
	AL-IS.2 mounting accessories for LSA				
	screw incl. Clamping nut	300530200	20	pce	
	AL-IS.2 covered fixation for LSA				
	Set	300530500	20	pce	

ASSEMBLY TOOLS FOR AL-IS INSECT REPELLING SYSTEM PRODUCTS

ALUKON

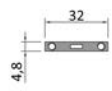
	Product description	article no.	p.u. m	Unit	price €
	Pressing tool				
	Dimensions: 660 x 560 x 1100 mm, working pressure: 7 bar, max operating pressure: 8 bar Application can be modified by changing cutters and stoppers.				
	for tensioning frame / frame door / sliding door (except RT 50)	891420300	1	pce	
	Mounting roller for inserts				
	for all AL-IS products / Set concave + convex	891420200	1	pce	
	AL-IS.2 Reparation slider 1,0mm				
	Stainless steel	300141210	50	pce	

15 EINBRUCHSCHUTZPROGRAMM

Anti-effraction

Protection against burglary

Program ochrany proti vloupání

System zabezpieczający przed włamaniem



Inbraakpreventie programma

Betörésgátló-program

EXTRUDED GUIDE CHANNEL

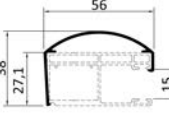

ALUKON

WITH GUIDE CHANNEL COVERS ROUND AND RECTANGULAR

	Product description	article no.	p.u. m	Unit	price €
	Guide channel A 3-ES.2				
	mill-finished	810300200	36	m	
	coated	8103002..	36	m	
	21 brown SF	26 white 9016 mat			
	silver anodized EV 1	810300241	36	m	
	bronze anodized BC 4 ..51, C 33 ..55	8103002..	36	m	
	RAL	810300299	36	m	
	Guide channel cover FAR-ES V2, half-round				
	mill-finished	814011000	36	m	
	coated	8140110..	36	m	
	21 brown SF	26 white 9016 mat			
	silver anodized EV 1	814011041	36	m	
	bronze anodized BC 4 ..51, C 33 ..55	8140110..	36	m	
	RAL	814011099	36	m	
	Guide channel cover FAG-ES.2, rectangular				
	mill-finished	814021000	36	m	
	coated	8140210..	36	m	
	21 brown SF	26 white 9016 mat			
	silver anodized EV 1	814021041	36	m	
	bronze anodized BC 4 ..51, C 33 ..55	8140210..	36	m	
	RAL	814021099	36	m	

STEEL END PARTS FOR A 3-ES GUIDE CHANNELS, WITH COVER

ALUKON

	Product description	article no.	p.u. m	Unit	price €
	Guide channel end part V2 A 3-ES + FAR-ES				
	Galvanized, left	119251500	10	pce	
	Galvanized, right	119251600	10	pce	
	standard colours , left	1192515..	10	pce	
	standard colours , right	1192516..	10	pce	
	08 silver	25 bronze C33 coated			
	09 bronze coated	26 white 9016 mat			
	RAL , left	119251599	10	pce	
RAL , right	119251699	10	pce		
	Guide channel end part V2 A 3-ES + FAG-ES				
	Galvanized, left	119251900	10	pce	
	Galvanized, right	119252000	10	pce	
	standard colours , left	1192519..	10	pce	
	standard colours , right	1192520..	10	pce	
	08 silver	25 bronze C33 coated			
	09 bronze coated	26 white 9016 mat			
	RAL , left	119251999	10	pce	
RAL , right	119252099	10	pce		

FOAMED ALUMINIUM ROLLER SHUTTER PROFILE MY 442-H WITH HARD FOAM (MINI)

ALUKON

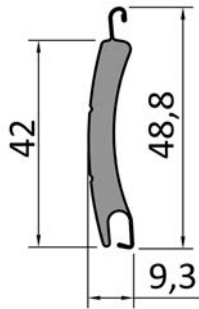

Technical data

Profile height	mm	48,80
Profile thickness	mm	9,30
Profile cover height	mm	42,00
Material thickness	mm	0,30
Weight	kg/m ²	4,32
Max width*	cm	400,00
Max area*	m ²	8,50
Length	cm	600,00
Packing unit	m	216,00

*Benchmark, definition corresponding to wind load table, according to EN 13659

Winding table (without insect repelling system)

box size	max height of element with 40 mm octagonal shaft in cm	max height of element with 60 mm octagonal shaft in cm
100	---	---
125	---	76
138	---	105
150	---	134
165	---	190
180	---	236
205	---	296

Bale diameter

height of curtain in cm	with 40 mm octagonal shaft in cm	with 60 mm octagonal shaft in cm
100	---	13,20
120	---	13,80
140	---	14,60
160	---	16,00
180	---	16,00
200	---	17,20
225	---	17,20
250	---	18,80
275	---	18,80
300	---	20,20

List of articles including prices in €/m

Part number without light slits	Part number with light slits	Colour description	Price
804430101	804430201	white	
804430102	804430202	grey	
804430103	804430203	velvet brown	
804430104	804430204	light beige	
804430107	804430207	natural	
804430127	804430227	cream white	
804430184	804430284	light ivory	

This product is also available on request in all colours of profil MY 442 (refer to page 7.3; minimum order quantity: 2808 m)

EXTRUDED DOUBLE WALL ALUMINIUM ROLLER SHUTTER PROFILE V 37 (MINI) (WITH STRUCTURED COATING)

ALUKON

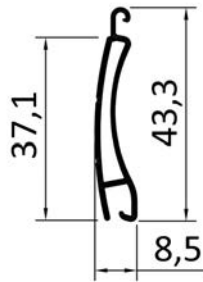

Technical data

Profile height	mm	43,30
Profile thickness	mm	8,50
Profile cover height	mm	37,10
Material thickness	mm	1,00
Weight	kg/m ²	7,00
Max width*	cm	350,00
Max area*	m ²	8,50
Length	cm	580,00
Packing unit	m	58,00

*Benchmark, definition corresponding to wind load table, according to EN 13659

Winding table (without insect repelling system)

box size	max height of element with 40 mm octagonal shaft in cm	max height of element with 60 mm octagonal shaft
125	89	78
138	122	108
150	159	145
165	200	185
180	245	234
205	330	330

Bale diameter

height of curtain in cm	with 40 mm octagonal shaft in cm	with 60 mm octagonal shaft in cm
100	12,80	13,20
120	13,60	14,60
140	14,40	14,60
160	14,40	16,00
180	15,80	16,00
200	16,20	17,40
225	17,00	17,40
250	17,00	18,80
275	18,40	18,80
300	19,60	20,00
325	19,60	20,00
350	19,60	21,40
375	21,40	21,40
400	21,40	22,20

List of articles including prices in €/m

Part number without light slits	Colour description	Price
802380100	mill-finished	
802380199	30 ALUKON structure colours	

Part number with light slits	Colour description	Price
802380200	mill-finished	
802380299	30 ALUKON structure colours	

For an overview of all 30 structured colours, please refer to "technical overview".

EXTRUDED DOUBLE WALL ALUMINIUM ROLLER SHUTTER PROFILE E 55 (MAXI) (WITH STRUCTURED COATING)

ALUKON

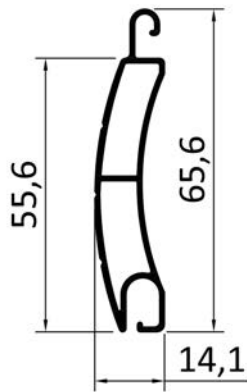

Technical data

Profile height	mm	65,60
Profile thickness	mm	14,10
Profile cover height	mm	55,60
Material thickness	mm	1,00
Weight	kg/m ²	8,50
Max width*	cm	500,00
Max area*	m ²	13,00
Length	cm	580,00
Packing unit	m	58,00

*Benchmark, definition corresponding to wind load table, according to EN 13659

Bale diameter

height of curtain in cm	with 60 mm octagonal shaft in cm	with 60/70 mm octagonal shaft and slide over ring 80 in cm
77.5	---	14,90
100	---	15,50
127.5	---	17,50
149.5	---	18,80
177.3	---	20,00
199.5	---	21,30
227	---	21,80
249.5	---	22,30
277	---	23,50
299	---	24,50

List of articles including prices in €/m

Part number without light slits	Colour description	Price
802550100	mill-finished	
802550199	30 ALUKON structure colours	



Part number with light slits	Colour description	Price
802550200	mill-finished	
802550299	30 ALUKON structure colours	

For an overview of all 30 structured colours, please refer to "technical overview".

POLYAMIDE LOCKING CLIPS

FOR HARD FOAM PROFILES AND EXTRUDED PROFILES

ALUKON

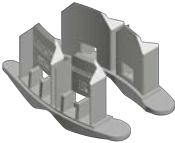
	Product description	article no.	p.u. m	Unit	price €
	Locking clips for MY 442-H (to paste in) for both sides (price per 100 pieces)	809410100	200	pce	
	Locking clips for M 317/ M 328 to punch for V 37 to paste in (punch tool please refer to p. 7.18) left + right (Price per 100 pair)	159370900	500	pair	
	Locking clips for E 55 (to rivet) left + right (Price per 100 pair)	809550300	100	pair	

END SLAT FOR SECURITY SHUTTERS

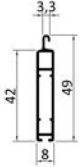
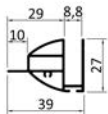

MADE OF EXTRUDED ALUMINIUM

ALUKON

	Product description	article no.	p.u. m	Unit	price €	
	End slat SL DB.2 - for covered stop -					
	Standard end slat for all PVC and foamed roller shutter profiles, with groove for PVC and brush inserts suitable PVC connecting buffers: swiveling					
	mill-finished	200410000	60	m		
	standard colours	2004100..	60	m		
	03 nougat brown 27 cream white 08 silver 82 charcoal 21 brown SF 84 light ivory 26 white 9016 mat					
	silver anodized EV 1	200410041	60	m		
	bronze anodized BC 4 ..51, C 33 ..55	2004100..	60	m		
	RAL	200410099	60	m		
	Angle end slat SL-ES					
	Special end slat to screw on SL DB.2, with groove below for PVC and brush inserts suitable PVC connecting buffers: swiveling					
	mill-finished	200500000	6	m		
	standard colours	2005000..	6	m		
	26 white 9016 mat					
	silver anodized EV 1	200500041	6	m		
	bronze anodized BC 4 ..51, C 33 ..55	2005000..	6	m		
RAL	200500099	6	m			

END SLAT ACCESSORIES FOR SECURITY ROLLER SHUTTER

ALUKON

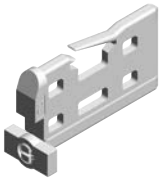
	Product description	article no.	p.u. m	Unit	price €
	Flat iron 6 x 16mm for SL-ES				
	to insert into SL-ES				
	made of steel (3,00 m)	209230100	3	m	
	End cap for SL-ES				
	made of PVC, to be connected laterally on the angle of SL-ES				
	black	209060100	10	pair	
	white	209032100	200	pce	
	black	209032200	200	pce	

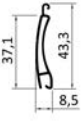
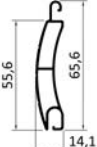

CURTAIN MADE OF EXTRUDED ALUMINIUM PROFILES



	Product description	article no.	p.u. m	Unit	Price / m ²
	Curtain MY 442-H (for technical details please refer to section 7)				
	standard colours locked	8244301..	1	pce	
	standard colours unlocked	8244300..	1	pce	
	01 white	04 beige			
	02 grey	07 natural			
	03 velvet brown	84 light ivory			
	Curtain V 37 (for technical details please refer to section 7)				
	30 ALUKON structure colours locked	822380199	1	pce	
	30 ALUKON structure colours unlocked	822380099	1	pce	
	Curtain E 55 (for technical details please refer to section 7)				
	30 ALUKON structure colours locked	822550199	1	pce	
	30 ALUKON structure colours unlocked	822550099	1	pce	

All curtains including spring bolt, standard end slat and buffers of your choice.

Attention : Minimum area for price calculation is 1 m².

	Product description	article no.	p.u. m	Unit	price €
	Extra charge end slat in special colour	829990300		m	
	surcharge shaft connector	829992900		m	
	Extra charge sliding bolt	829993100		pce	
	Extra charge cylinder lock mini	829993200		pce	
	Extra charge end slat WSL	829993900		m	
	Extra charge end slat SL-ES	829994000		m	
	Surcharge for design end slat	829994400		m	

	Product description	article no.	p.u. m	Unit	price €
	<p>Sliding bolt</p> <p>Two sliding bolts are installed on the end slat; the bolts are locking into the corresponding gap, therefore the roller shutter curtain lifting is impossible. To handle the sliding bolt, the window should be opened.</p>				
	for SL KU /-N, SL DB.2, SL A9, SL 521-DB.2	891210200	1	pce	
	<p>Bar lock ("basquille lock")</p> <p>The function is nearly the same as for the sliding bolt, but the end slat can be locked additionally with a key. Bar lock operation usually from outside.</p>				
	for SL DB.2	891220100	1	pce	

	Product description	article no.	p.u. m	Unit	price €
	drilling template for profiles				
	made of steel	809411300	1	pce	
	drilling template for end slat SL-ES				
	made of steel	809411400	1	pair	

16 ZIPTEX - PROGRAMM

ZUR TEXTILEN BESCHATTUNG ODER VERDUNKLUNG

ZipTex - ombrager avec tissu textile ou obscurcir de grandes surfaces vitrées

ZipTex - for textile shadowing or blackout effect

Program ZipTex - textilie pro zastínění nebo zatemnění

ZipTex - system do tekstylnych oston i zaciemnień

ZipTex - programma als doekzonwering of verduistering

ZipTex - program textil árnyékolásra vagy sötétítésre

EXTRUDED BOX, BEVELLED 20°

- FRONT ACCESS -

ALUKON

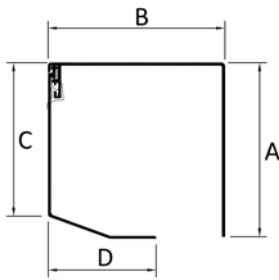

- made of extruded aluminium
- surface powder coated
- without protection film
- 3-parts (OT/LRS/RR), as left or right roller

size	WBH		LRS	
	A	B	C	D
90	90	90	89	49
100	101	102	100	60
125	126	127	124	85
138	138	139	136	99

available colours with colour no.

00 mill-finished

standard colours (no RAL)

99 RAL (without protection film)

List of articles including prices in €/m

description	part number + colour number (...)	packing unit m	mill-finished	standard colours	RAL
WBH 90	0109070..	30			
LRS-20° 90	0109040..	30			
WBH 100	0110070..	24			
LRS-20° 100	0110040..	30			
WBH 125	0112570..	18			
LRS-20° 125	0112540..	30			
WBH 138	0113870..	12			
LRS-20° 138	0113840..	30			

EXTRUDED BOX, BEVELLED 20°

- BOTTOM ACCESS -

ALUKON

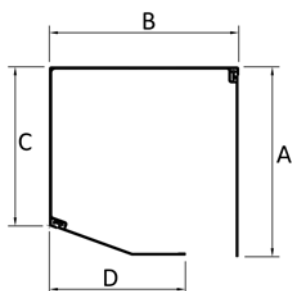

- made of extruded aluminium
- surface powder coated
- without protection film
- 4-parts (VB/RK/OT/RR) or 3-parts (WB/RK/RR), as left roller or right roller

Stock service only for mill-finished boxes.

	RR	OT	VB	RK
size	A	B	C	D
90	91	91	74	49
100	102	102	89	60

available colours with colour no.

00 mill-finished

standard colours (no RAL)

99 RAL (without protection film)

	RR	WB		RK
size	A	B	C	D
125	127	127	108	85
138	139	139	117	99

List of articles including prices in €/m

description	part number + colour number (...)	packing unit m	mill-finished	standard colours	RAL
OT 90	0109010..	30			
VB 20°, 90	0209011..	30			
RK 20°, 90	0209020..	30			
RR o.T. 90	0109031..	30			
OT 100	0110010..	30			
VB 20°, 100	0210011..	30			
RK 20°, 100	0210020..	30			
RR o.T. 100	0110031..	30			
WB 125	0212510..	30			
RK 20°, 125	0212520..	30			
RR o.T. 125	0112531..	30			
WB 138	0213810..	30			
RK 20°, 138	0213820..	30			
RR o.T. 138	0113831..	30			

EXTRUDED BOX, RECTANGULAR 90°

ALUKON

- BOTTOM ACCESS -

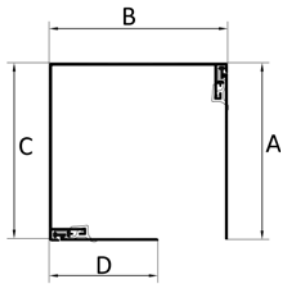

- made of extruded aluminium
- surface powder coated
- without protection film
- 4-parts (VB/RK/OT/RR), as left roller and right roller

Stock service only for mill-finished boxes.

	RR	WB 90°		RKZ
size	A	B	C	D
90	91	91	91	49
100	102	102	102	60
125	127	127	127	85

available colours with colour no.

00 mill-finished

standard colours (no RAL)

99 RAL (without protection film)

	RR	OT	VB	RR
size	A	B	C	D
138	139	139	139	88

List of articles including prices in €/m

description	part number + colour number (...)	packing unit m	mill-finished	standard colours	RAL
WB-90° 90	0209040..	24			
RKZ 90° 90	0209031..	30			
RR o.T. 90	0109031..	30			
WB-90° 100	0210040..	18			
RKZ 90° 100	0210031..	30			
RR o.T. 100	0110031..	30			
WB-90° 125	0212540..	18			
RKZ 90° 125	0212531..	30			
RR o.T. 125	0112531..	30			
RR 138	0113831..	30			
OT 138	0113810..	30			
VB 90° 138	0113820..	30			
RR o.T. 90	0109031..	30			

EXTRUDED BOX, RECTANGULAR 90°

ALUKON

- FRONT ACCESS -

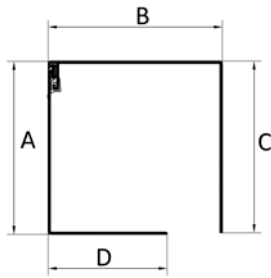

- Made of extruded aluminium
- power coated surface
- without protection film
- end caps are only stocked in mill-finished version

size	WBH		LR - 90°	
	A	B	C	D
90	91	91	91	49
100	102	102	102	60
125	127	127	127	85
138	139	139	139	90

available colours with colour no.

00 mill-finished

standard colours (no RAL)

99 RAL (without protection film)

List of articles including prices in €/m

description	part number + colour number (...)	packing unit m	mill-finished	standard colours	RAL
WBH 90	0109070..	30			
LR - 90° 90	0109060..	30			
WBH 100	0110070..	24			
LR - 90° 100	0110060..	30			
WBH 125	0112570..	18			
LR - 90° 125	0112560..	24			
WBH 138	0113870..	12			
LR - 90° 138	0113860..	18			

BOX PARTS FOR EXTRUDED BUILT-IN BOX, BEVELLED VERSION 20°

ALUKON

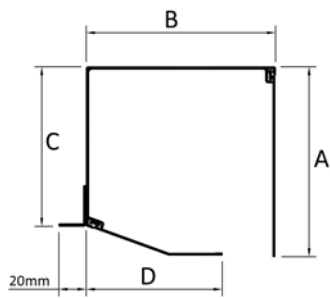

- made of extruded aluminium
- surface powder coated
- without protection film
- 4-parts (VB/RK/OT/RR) or 3-parts (WB/RK/RR), as left roller or right roller

Stock service only for mill-finished boxes.

	RR	OT	VB	RK
size	A	B	C	D
100	102	102	89	60

available colours with colour no.

00 mill-finished

standard colours (no RAL)

99 RAL (without protection film)

	RR	WB		RK
size	A	B	C	D
125	127	127	111	85
138	139	139	120	99

List of articles including prices in €/m

description	part number + colour number (...)	packing unit m	mill-finished	standard colours	RAL
OT 100	0110010..	30			
VB 20° 100	0210011..	30			
RK 20° 100	0210020..	30			
RR o.T. 100	0110031..	30			
WB 125	0212510..	30			
RK-20° 125	0212520..	30			
RR o.T. 125	0112531..	30			
WB 138	0213810..	30			
RK-20° 138	0213820..	30			
RR o.T. 138	0113831..	30			

BOX PARTS FOR EXTRUDED BUILT-IN BOX, RECTANGULAR VERSION 90°

ALUKON

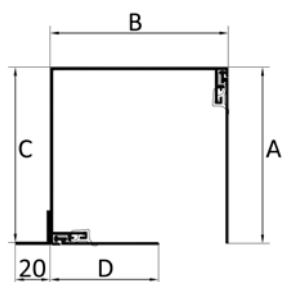

- made of extruded aluminium
- surface powder-coated
- without protection film
- 4-parts (OT/VB/RK/RR), as left roller or right roller

Stock service only for mill-finished boxes.

	RR	WB 90°		RKZ
size	A	B	C	D
100	102	102	102	60
125	127	127	127	85

available colours with colour no.

00 mill-finished

standard colours (no RAL)

99 RAL (without protection film)

	RR	OT	VB	RR
size	A	B	C	D
138	139	139	139	88

List of articles including prices in €/m

description	part number + colour number (...)	packing unit m	mill-finished	standard colours	RAL
WB 90°, 100	0210040..	24			
RKZ-90° 100	0210031..	30			
RR o.T. 100	0110031..	30			
WB 90°, 125	0212540..	18			
RKZ-90° 125	0212531..	30			
RR o.T. 125	0112531..	30			
OT 138	0113810..	30			
VB 90° 138	0113820..	30			
RR o.T. 90	0109031..	30			
RR o.T. 138	0113831..	30			

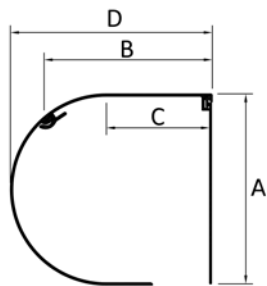

- made of extruded aluminium
- surface powder coated
- without protection film
- 3-parts (ROT/RUT/RR)

Stock service only for mill-finished boxes.

	RR	ROT		RUT
size	A	B	C	D
138	141	123	78	148

available colours with colour no.

00 mill-finished

standard colours (no RAL)

99 RAL (without protection film)

List of articles including prices in €/m

description	part number + colour number (...)	packing unit m	mill-finished	standard colours	RAL
ROT 138	2513811..	30			
RUT 138	2513821..	30			
RR o.T. 138	0113831..	30			

PRESSURE MOULDED END CAPS ZIPTEX.3, BEVELLED VERSION 20°

ALUKON

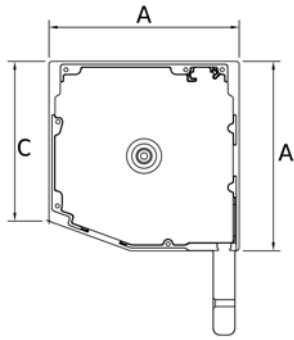

- made of special aluminium alloy
- pressure moulded
- (cannot be anodised)

Stock service only for mill-finished end caps, available in pairs only.

size	A	C
90	91	74
100	102	89
125	127	108
138	139	117

available colours with colour no.

00 mill-finished

standard colours (no RAL)

99 RAL

List of articles including prices in €/pair

description	part number + colour number (...)	packing unit pair	mill-finished	standard colours	RAL
BKS-Z 90, 20°	7410901..	10			
BKS-Z 100, 20°	7411001..	10			
BKS-Z 125, 20°	7411251..	10			
BKS-Z 138, 20°	7411381..	10			

PRESSURE MOULDED END CAPS ZIPTEX.3, RECTANGULAR VERSION 90°

ALUKON

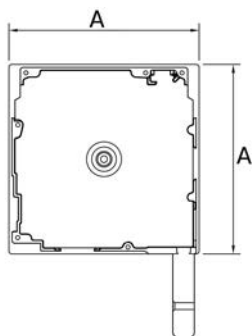

- made of special aluminium alloy
- pressure moulded
- (cannot be anodised)

Stock service only for mill-finished end caps, available in pairs only.

size	A
90	91
100	102
125	127
138	139

available colours with colour no.

00 mill-finished

standard colours (no RAL)

99 RAL

List of articles including prices in €/pair

description	part number + colour number (...)	packing unit pair	mill-finished	standard colours	RAL
BK-Z 90	7410902..	10			
BK-Z 100	7411002..	10			
BK-Z 125	7411252..	10			
BK-Z 138	7411382..	10			

PRESSURE MOULDED END CAPS ZIPTEX.3, ROUND VERSION

ALUKON

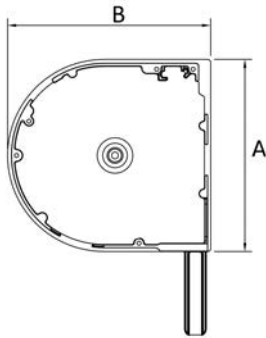

- with staggered pin
- made of special aluminium alloy
- pressure moulded (cannot be anodized)

Stock service only for mill-finished end caps, available in pairs only.

size	A	B
138	141	148

available colours with colour no.

00 mill-finished

standard colours (no RAL)

99 RAL

List of articles including prices in €/pair

description	part number + colour number (...)	packing unit pair	mill-finished	standard colours	RAL
BKR-Z 138	7411383..	10			

DIE CASTED END CAPS WIRETEX

BEVELLED VERSION 20°

ALUKON

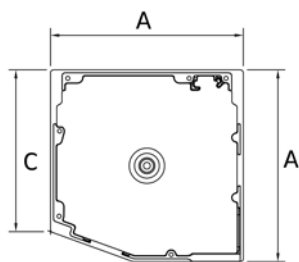

- made of a special aluminium alloy
- pressure moulded (cannot be anodized)
- with milled foot-part

size	A	C
90	91	74
100	102	89
125	127	108

available colours with colour no.

00 mill-finished

standard colours (no RAL)

99 RAL

article no.+ colour no. (..)

description	part number + colour number (..)	packing unit piece	mill-finished	standard colours	RAL
BKS-W 90, 20° linke	7410931..	10			
BKS-W 90, 20° rechte	7410932..	10			
BKS-W 100, 20° linke	7411031..	10			
BKS-W 100, 20° rechte	7411032..	10			
BKS-W 125, 20° linke	7411231..	10			
BKS-W 125, 20° rechte	7411232..	10			

DIE CASTED END CAPS WIRETEX

RECTANGULAR VERSION 90°

ALUKON

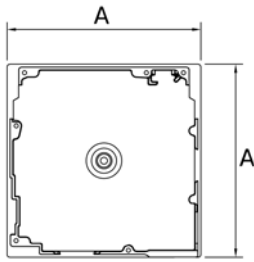

- made of a special aluminium alloy
- pressure moulded (cannot be anodized)
- with milled foot-part

size	A
90	91
100	102
125	127

available colours with colour no.

00 mill-finished

standard colours (no RAL)

99 RAL

article no.+ colour no. (..)

description	part number + colour number (..)	packing unit piece	mill-finished	standard colours	RAL
BK-W 90, 90° linke	7410941..	10			
BK-W 90, 90° rechte	7410942..	10			
BK-W 100, 90° linke	7411041..	10			
BK-W 100, 90° rechte	7411042..	10			
BK-W 125, 90° linke	7411241..	10			
BK-W 125, 90° rechte	7411242..	10			

PRESSURE MOULDED END CAPS ZIPTEX.3, - SKIMMED-

ALUKON

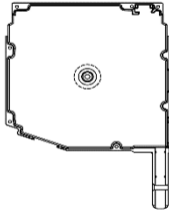

- without edge
- available in sizes 90 - 138 for ZipTex
- available in versions 20° and 90°

description	Part no. + color no. left side	Part no. + color no. right side	pce	mill-fin- ished	RAL
BKS-Z 90 20°	7410911..02	7410912..02	1		
BKS-Z 100 20°	7411011..02	7411012..02	1		
BKS-Z 125 20°	7411211..02	7411212..02	1		
BKS-Z 138 20°	7411311..02	7411312..02	1		
BK-Z 90 90°	7410921..02	7410922..02	1		
BK-Z 100 90°	7411021..02	7411022..02	1		
BK-Z 125 90°	7411221..02	7411222..02	1		
BK-Z 138 90°	7411321..02	7411322..02	1		

DIE CASTED END CAPS WIRETEX

- SKIMMED-

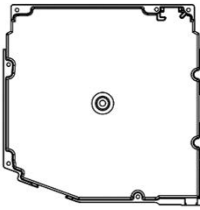







- without edge
- available in sizes 90 - 125 without foot part for WireTex
- available in versions 20° and 90°

description	Part no. + color no. left side	Part no. + color no. right side	pce	mill-fin- ished	standard colours	RAL
BKS-W 90 20°	7410931..02	7410932..02	1			
BKS-W 100 20°	7411031..02	7411032..02	1			
BKS-W 125 20	7411231..02	7411232..02	1			
BK-W 90 90°	7410941..02	7410942..02	1			
BK-W 100 90°	7411041..02	7411042..02	1			
BK-W 125 90°	7411241..02	7411242..02	1			



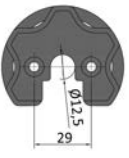



ACCESSORIES FOR END CAPS AND ALUKON-MOTOR BEARING PLATE (MLP)





ALUKON

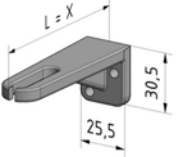

	Product description	article no.	p.u. m	Unit	price €
	Inlay box connection for box type 20°, 100 for box type 90°				
	mill-finished	748050100	40	pce	
	Safety plate steel, Uni for ZipTex.3				
	AWB-Z.3 Uni 90	748060102	10	pce	
	AWB-Z.3 Uni 100	748060202	10	pce	
	AWB-Z.3 Uni 125	748060302	10	pce	
		748060401	10	pce	
	safety plate steel, Uni for WireTex				
	AWB-W Uni 90 left	748061110	10	pce	
	AWB-W Uni 90 right	748061120	10	pce	
	AWB-W Uni 100 left	748061210	10	pce	
	AWB-W Uni 100 right	748061220	10	pce	
	AWB-W Uni 125 left	748061310	10	pce	
	AWB-W Uni 125 right	748061320	10	pce	
	Stopper for ZipTex				
	black	748030100	20	pair	
	ALUKON-motor bearing plate				
		748065300	50	pce	
	Star adapter for Becker motors				
	black	748065200	1	pce	
	Box suspension L=5cm f. ZipTex.3 & WireTex				
	mill finished	190290600	20	pce	
	standard colours	1902906..	20	pce	
	RAL	190290699	20	pce	
	Box suspension long f. ZipTex.3 & WireTex				
	mill finished	190290500	24	m	
	standard colours	1902905..	24	m	
	RAL	190290599	24	m	

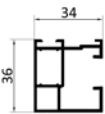
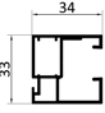
ACCESSORIES FOR END CAPS AND ALUKON-MOTOR BEARING PLATE (MLP)

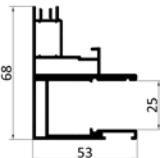
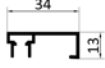

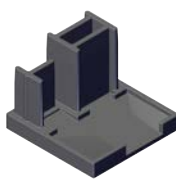
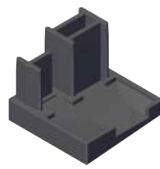
ALUKON

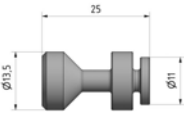

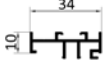
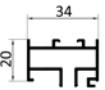
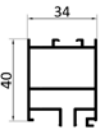

	Product description	article no.	p.u. m	Unit	price €
	Stopper for WireTex				
	black	748030200	50	pce	
	Box damping f. ZipTex,3 and WireTex				
	natural	748050200	100	pce	
	Clamping sleeve M8x20 f. WireTex				
	natural	891191300	100	pce	
	spring for clamping sleeve				
	natural	734105300	100	pce	
	guying angle 15-36 mm f. WireTex				
	mill finished	734121000	200	pce	
	RAL	734121099	200	pce	
	stainless steel wire for WireTex				
	natural	739040202	1000	m	

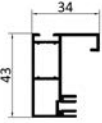

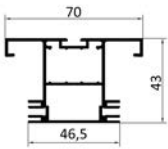
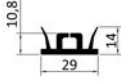
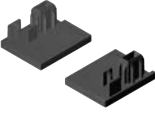
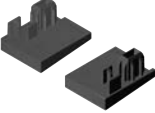

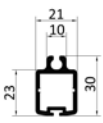
	Product description	article no.	p.u. m	Unit	price €
	Guide channel A38				
	mill finished	743000600	36	m	
	standard colours	7430006..	36	m	
	RAL	743000699	36	m	
	Guide channel A39 for right roller				
	mill finished	743000700	36	m	
	standard colours	7430007..	36	m	
	RAL	743000799	36	m	
	double guide channel DF A 38				
	mill finished	743000800	18	m	
	standard colours	7430008..	18	m	
	RAL	743000899	18	m	
	Guide channel A301-GS				
	mill finished	743001500	12	m	
	standard colours	7430015..	12	m	
	RAL	743001599	12	m	
	Cover for A301-GS				
	mill finished	743001600	36	m	
	standard colours	7430016..	36	m	
	RAL	743001699	36	m	
	snap-on plastic guide				
	black	743001200	30	m	
	Guide channel cover f. ZipTex.3, made of PVC				
	PVCblack	748040400	20	pair	
	Guide channel cover f. ZipTex.3, inclined 5°				
	PVC black	748040500	20	pair	

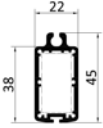
	Product description	article no.	p.u. m	Unit	price €
	Guide channel inlay f. ZipTex.3, stainless steel				
	left	748040610	20	pce	
	right	748040620	20	pce	
	Clamping bolt 13,5x25 for Zip guide channels for clamping of the distance piece				
	mill-finished	100830100	10	pce	
	Clamping bolt 13,5x25 for Zip double guide channels for clamping of the distance piece				
	mill-finished	100830200	10	pce	
	Support profile 10 mm for single guide channels				
	mill finished	743010000	36	m	
	standard colours	7430100..	36	m	
	RAL	743010099	36	m	
	Support profile 20 mm for single guide channels				
	mill finished	743020000	36	m	
	standard colours	7430200..	36	m	
	RAL	743020099	36	m	
	Support profile 40 mm for single guide channels				
	mill finished	743040000	36	m	
	standard colours	7430400..	36	m	
	RAL	743040099	36	m	



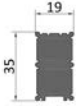



Doubling for DT A38 see chapter 5

	Product description	article no.	p.u. m	Unit	price €
	Guide rail A 31-G				
	mill-finished	743000300	36	m	
	standard colours	7430003..	36	m	
	RAL	743000399	36	m	
	Guide rail A 32				
	mill-finished	743000400	36	m	
	standard colours	7430004..	36	m	
	RAL	743000499	36	m	
	Double guide rail DF A31-G				
	mill-finished	743000500	36	m	
	standard colours	7430005..	36	m	
	RAL	743000599	36	m	
	Plastic guide for A 31-G and DF A 31-G				
	black	743001100	30	m	
	Guide rail cover A31-G and DF A31-G				
	black	748040100	20	pair	
	Guide rail cover A31-G and DF A31-G				
	black	748040300	20	pair	

	Product description	article no.	p.u. m	Unit	price €
	End slat SL ZipTex.3				
	mill-finished	744000200	30	m	
	standard colours	7440002..	30	m	
	RAL	744000299	30	m	
	Reinforcement iron				
	16 x 16 mm, galvanized	748011100	6	m	
	Slider part 1 and part 2				
	black	748010100	40	pce	
	end slat big SL_Tex 38 mm				
	black	744000300	30	m	
	reinforcement iron f. SL Tex 38 mm				
	15x30 mm	748011200	4	m	
	reinforcement iron hollow section, f. end slat big				
	15x30 mm galvanised	748011300	6	m	

	Product description	article no.	p.u. m	Unit	price €
	Sealing SL Tex 38 mm transparent	748010900	100	pce	
	slider for SL Tex 38 mm part 1 + part 2 black	748010200	40	pce	
	slider for WireTex part 1 + part 2 black	748010300	40	pce	
	Brush for end slat 12,5 mm	300135790	150	m	

	Product description	article no.	p.u. m	Unit	price €
	Grooved shaft 63 x 1 mm with round groove for ZipTex				
	galvanized	742000200	6	m	
	Grooved shaft 78 x 1 mm with round groove for ZipTex				
	galvanized	742000100	6	m	
	Grooved shaft 100 x 1,5 mm with round groove for ZipTex				
	galvanized	742000300	6	m	
	Roller cap for 63mm ZipTex shaft incl. slider				
	black	748025200	10	pce	
	Roller cap for 78mm ZipTex shaft incl. slider				
	black	748025100	10	pce	
	Roller cap for 100mm ZipTex shaft incl. slider				
	black	748025300	10	pce	
	Ball bearing for ZipTex 28 x 12 mm				
	for roller cap	749010300	10	pce	

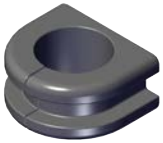

	Product description	article no.	p.u. m	Unit	price €
	Adapter for all motor types				
	shaft 63 mm V2	748021201	20	pce	
	shaft 78 mm V2	748021101	20	pce	
	shaft 100 mm V2	748021301	10	pce	
	Driver for Selve motors				
	shaft 63 mm	748023200	1	pce	
	shaft 78 mm	748023100	1	pce	
	shaft 100 mm	748023300	1	pce	
	Driver for Becker motors				
	shaft 63 mm	748022200	1	pce	
	shaft 78 mm	748022100	1	pce	
	shaft 100 mm	748022300	1	pce	
	Driver for Somfy motors				
	shaft 63 mm	749011600	1	pce	
	shaft 78 mm	749011500	1	pce	
	shaft 100 mm	749011700	1	pce	
	Worm gear 4:1 for ZipTex				
		240200100	1	pce	
	Roller cap octagonal 7mm 4-Kt for worm gear 4:1				
		240201300	1	pce	
	Adapter Zip for worm gear 4:1				
		748021000	20	pce	
	U-shaped bushing spout				
		249460001	100	pce	

selve drives	traction in kg up to height					length in cm	Part no.	price / piece
	1,50 m kg	2,50 m kg	3,50 m kg	4,50 m kg	6,00 m kg			
with electronic switch-off								
Motor SEZ 2/7, 3 m cable	22	18	16	14	12	52,50	246021100	
Motor SEZ 2/10, 3 m cable	28	25	23	20	18	52,50	246021200	
Motor SEZ 2/20, 3 m cable	45	42	40	38	36	56,50	246021400	
radio controlled drives								
Motor SEZ-RC 2/7, 3 m cable	22	18	16	14	12	52,50	246031100	
Motor SEZ-RC 2/10, 3 m cable	28	25	23	20	18	52,50	246031200	
Motor SEZ-RC 2/20, 3 m cable	45	42	40	38	36	56,50	246031400	

becker drives	traction in kg up to height					length in cm	Part no.	price / piece
	1,50 m kg	2,50 m kg	3,50 m kg	4,50 m kg	6,00 m kg			
with electronic switch-off								
R8-E18	25	20	18	15	13	52,80	247018100	
R12-E18	29	27	26	23	21	52,80	247018200	
R20-E18	43	42	40	38	36	55,70	247018300	
radio controlled drives for sunscreens Centronic Plus								
R 8/17 C18+	25	20	18	15	13	52,80	247016500	
R 12/17 C18+	29	27	26	23	21	52,80	247016600	
R 20/17 C18+	43	42	40	38	36	55,70	247016700	

somfy drives	traction in kg up to height					length in cm	Part no.	price / piece
	1,50 m kg	2,50 m kg	3,50 m kg	4,50 m kg	6,00 m kg			
with electronic switch-off								
Oximo WT 6/17	19	15	13	12	10	57,50	241022100	
Oximo WT 10/17	28	25	23	20	18	57,50	241022200	
Oximo WT 15/17	36	34	32	30	25	62,50	241022300	
Oximo WT 20/17	43	42	40	38	36	62,50	241022400	
radio controlled drives for sunscreens io								
io 6/17 - Maestria	19	15	13	12	10	57,50	241029100	
io 10/17 - Maestria	28	25	23	20	18	57,50	241029200	
io 15/17 - Maestria	36	34	32	30	25	62,50	241029300	
io 25/17 - Maestria	43	42	40	38	36	62,50	241029400	
radio controlled drives for sunscreens RTS								
Altus 50 RTS 6/17	19	15	13	12	10	57,50	241027100	
Altus 50 RTS 10/17	28	25	23	20	18	57,50	241027200	
Altus 50 RTS 15/17	36	34	32	30	25	62,50	241027300	
Altus 50 RTS 20/17	43	42	40	38	36	62,50	241027400	

Drive systems are provided with plug-in cable.

	Product description	article no.	p.u. m	Unit	price €
	Solar kit 6/18	241050700	1	pce	
	Solar kit 10/12	241050800	1	pce	
	Free wheel for Sunea 40 Solar io, installation left	241055400	1	pce	
	Free wheel for Sunea 40 Solar io, installation right	241055500	1	pce	

Product description

ALUKON ZipTex curtains have a lateral zipper. The upper and lower seams are sewn resp. welded at the inside. For fixation of the tube resp. end slat, the seams are equipped with an insert

Technical specification for ZipTex fabric

description	Soltis 92	Solits 86	Satiné 5500	twilight PEARL 297	Soltis B92
Composition	Polyester fabric	Polyester fabric	Glass fibre thread (42%) with PVC-coating (58%)	Polyester	Polyester fabric
Available width	177 cm	177 cm	250 cm	220 cm	170 cm
Fire protection class	B-s2, d0 / B1 / M1	B-s2, d0 / B1 / M1	B1 / M1 / C, s3, d0	B1	B-s2, d0 / B1 / M2
Thickness	ca. 0,45 mm	ca. 0,45 mm	ca. 0,75 mm	ca. 0,5 mm	ca. 0,60 mm
Weight	ca. 420 g/m ²	ca. 380 g/m ²	ca. 520 g/m ²	ca. 340 g/m ²	ca. 650 g/m ²
Tear resistance (warp direction)	310 daN/5 cm	230 daN/5 cm	170 daN/5 cm	155 daN/5 cm	330 daN/5 cm
Tear resistance (weft direction)	210 daN/5 cm	160 daN/5 cm	170 daN/5 cm	105 daN/5 cm	220 daN/5 cm

List of products including prices in € / m²

Description	Part number	Price / m ²
Soltis 92	518001064	
Solits 86	518001063	
Satiné 5500	518001062	
twilight PEARL 297	518001083	
Soltis B92	518001069	

For colours descriptions please refer to our catalogue.

17 RAFFSTORENPROGRAMM

BSO

Venetian blinds

Předokenní žaluzie s roletovou schránkou a příslušenství

Żaluzje fasadowo-okienne oraz elementy dodatkowe

Onderdelen voor horizontale buitenjaloerieën

Külsőtökös zsaluzia-program

EXTRUDED BOX, BEVELLED 20°

ALUKON

FOR FRONT-MOUNTED ELEMENTS WITH EXTERIOR BLINDS

- FRONT ACCESS -

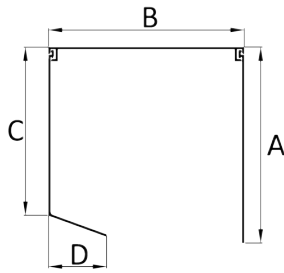

- made of extruded aluminium
- surface powder coated or anodized
- without protection film
- from box 180 also suitable for integrated insect repelling system
- three-parts (OT/RS UT 20° /RR)

Stock service only for mill-finished boxes.

	RR	OT	RS UT 20°	
size	A	B	C	D
165	168	168	145	48
180	184	184	156	49
205	210	210	179	74

available colours with colour no.

00 mill-finished

standard colours (no RAL)

ELOX

41 silver anod. EV 1

55 bronze anod. C 33

51 bronze anod. BC 4

RAL

99 RAL (without protection film)

List of articles including prices in €/m

description	part number + colour number (...)	packing unit m	mill-finished	standard colours	silver anod.	bronze anod.	RAL
OT 165	0116510..	30					
RS UT 20° 165	7301165..	30			---	---	
RR o.T. 165	0116531..	30					
OT 180	0118010..	12					
RS UT 20° 180	7301180..	12			---	---	
RR o.T. 180	0118031..	12					
OT 205	0120510..	12					
RS UT 20° 205	7301205..	12			---	---	
RR o.T. 205	0120531..	12					

EXTRUDED BOX, BEVELLED 20°

ALUKON

FOR FRONT-MOUNTED ELEMENTS WITH EXTERIOR BLINDS
- BOTTOM ACCESS -

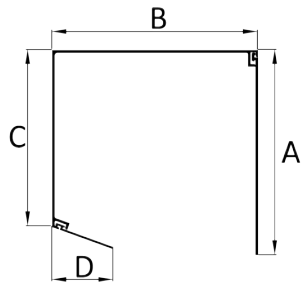

- made of extruded aluminium
- surface powder coated or anodized
- without protection film
- from box 180 also suitable for integrated insect repelling system
- 3-parts (WB/RS RK/RR)

Stock service only for mill-finished boxes.

	RR	WB		RS RK
size	A	B	C	D
165	168	168	145	46
180	184	184	156	47
205	210	210	179	71

available colours with colour no.

00 mill-finished

standard colours (no RAL)

ELOX

41 silver anod. EV 1

55 bronze anod. C 33

51 bronze anod. BC 4

RAL

99 RAL (without protection film)

List of articles including prices in €/m

description	part number + colour number (...)	packing unit m	mill-finished	standard colours	silver anod.	bronze anod.	RAL
WB 165	0216510..	30					
RS RK 165 20° /90°	7303165..	30			---	---	
RR o.T. 165	0116531..	30					
WB 180	0218010..	12					
RS RK 180 20° /90°	7303180..	12			---	---	
RR o.T. 180	0118031..	12					
OT 205	0120510..	12					
VB 205	0220511..	12					
RS RK 205 20° /90°	7303205..	12			---	---	
RR o.T. 205	0120531..	12					

EXTRUDED BOX, BEVELLED 45°

FOR FRONT-MOUNTED ELEMENTS WITH EXTERIOR BLINDS

ALUKON

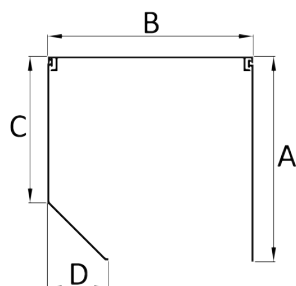

- made of extruded aluminium
- surface powder coated or anodized
- without protection film
- from box 180 also suitable for integrated insect repelling
- 3-parts (OT/RS UT 45° /RR)

Stock service only for mill-finished boxes.

	RR	OT	RS UT 45°	
size	A	B	C	D
165	169	169	121	47
180	184	184	133	51
205	209	209	151	74

available colours with colour no.

00 mill-finished

standard colours (no RAL)

ELOX

41 silver anod. EV 1

55 bronze anod. C 33

51 bronze anod. BC 4

RAL

99 RAL (without protection film)

List of articles including prices in €/m

description	part number + colour number (...)	packing unit m	mill-finished	standard colours	silver anod.	bronze anod.	RAL
OT 165	0116510..	30					
RS UT 45° 165	7302165..	30			---	---	
RR o.T. 165	0116531..	30					
OT 180	0118010..	12					
RS UT 45° 180	7302180..	12			---	---	
RR o.T. 180	0118031..	12					
OT 205	0120510..	12					
RS UT 45° 205	7302205..	12			---	---	
RR o.T. 205	0120531..	12					

EXTRUDED BOX, RECTANGULAR 90°

ALUKON

FOR FRONT-MOUNTED ELEMENTS WITH EXTERIOR BLINDS
- BOTTOM ACCESS -

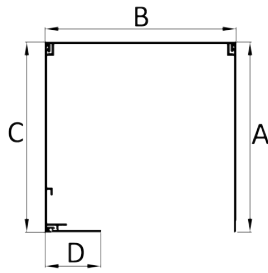

- made of extruded aluminium
- surface powder coated or anodized
- without protection film
- from box 180 also suitable for integrated insect repelling system
- 4-parts (OT/VB 90° /RS RK/RR)

Stock service only for mill-finished boxes.

	RR	OT	VB 90°	RS RK
size	A	B	C	D
165	168	168	168	46
180	184	184	184	47
205	209	209	209	71

available colours with colour no.

00 mill-finished

standard colours (no RAL)

ELOX

41 silver anod. EV 1

55 bronze anod. C 33

51 bronze anod. BC 4

RAL

99 RAL (without protection film)

List of articles including prices in €/m

description	part number + colour number (...)	packing unit m	mill-finished	standard colours	silver anod.	bronze anod.	RAL
OT 165	0116510..	30					
VB 90° 165	0116520..	30			---	---	
RS RK 165 20° /90°	7303165..	30			---	---	
RR o.T. 165	0116531..	30					
OT 180	0118010..	12					
VB 90° 180	0118020..	12			---	---	
RS RK 180 20° /90°	7303180..	12			---	---	
RR o.T. 180	0118031..	12					
OT 205	0120510..	12					
VB 90° 205	0120520..	12			---	---	
RS RK 205 20° /90°	7303205..	12			---	---	
RR o.T. 205	0120531..	12					

EXTRUDED BOX, ROUND

FOR FRONT-MOUNTED ELEMENTS WITH EXTERIOR BLINDS

ALUKON

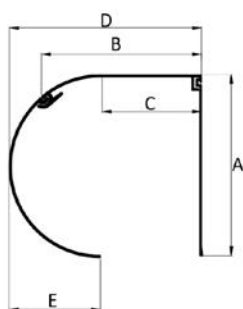

- made of extruded aluminium
- surface powder coated or anodized
- without protection film
- from box 180 also suitable for integrated insect repelling system
- 3-parts (ROT/RS-UT/RR)

Stock service only for mill-finished boxes.

	RR	ROT		RS UT	
size	A	B	C	D	E
165	169	146	92	176	54
180	183	158	99	191	56
205	210	183	113	219	84

available colours with colour no.

00 mill-finished

standard colours (no RAL)

ELOX

41 silver anod. EV 1 55 bronze anod. C 33
51 bronze anod. BC 4

RAL

99 RAL (without protection film)

List of articles including prices in €/m

description	part number + colour number (...)	packing unit m	mill-finished	standard colours	silver anod.	bronze anod.	RAL
ROT 165	2516511..	30					
RS UT 165	7304165..	30			---	---	
RR o.T.165	0116531..	30					
ROT 180	2518011..	12					
RS UT 180	7304180..	12			---	---	
RR o.T. 180	0118031..	12					
ROT 205	2520511..	12					
RS UT 205	7304205..	12			---	---	
RR o.T. 205	0120531..	12					

EXTRUDED BUILT-IN BOX, BEVELLED 20°

FOR FRONT-MOUNTED ELEMENTS WITH EXTERIOR BLINDS

ALUKON

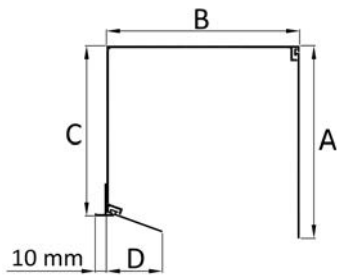

- made of extruded aluminium
 - surface powder coated or anodized
 - without protection film
 - from box 180 also suitable for integrated insect repelling system
 - 3-parts (WB/RS RK/RR)
- End profile for box KAP and aluminium angle see section 3

Stock service only for mill-finished boxes.

	RR	WB		RS RK
size	A	B	C	D
165	168	168	148	46
180	184	184	159	47
205	210	210	171	71

available colours with colour no.

00 mill-finished

standard colours (no RAL)

ELOX

41 silver anod. EV 1

55 bronze anod. C 33

51 bronze anod. BC 4

RAL

99 RAL (without protection film)

List of articles including prices in €/m

description	part number + colour number (...)	packing unit m	mill-finished	standard colours	silver anod.	bronze anod.	RAL
WB 165	0216510..	30					
RS RK 165 20° / 90°	7303165..	30			---	---	
RR o.T. 165	0116531..	30					
WB 180	0218010..	12					
RS RK 180 20° / 90°	7303180..	12			---	---	
RR o.T. 180	0118031..	12					
OT 205	0120510..	12					
VB 205	0220511..	12					
RS RK 205 20° / 90°	7303205..	12			---	---	
RR o.T. 205	0120531..	12					

EXTRUDED BUILT-IN BOX, RECTANGULAR 90°

FOR FRONT-MOUNTED ELEMENTS WITH EXTERIOR BLINDS

ALUKON

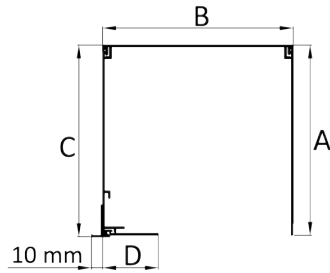

- made of extruded aluminium
 - surface powder coated or anodized
 - without protection film
 - from box 180 also suitable for integrated insect repelling system
 - 4-parts (OT/VB 90° /RS RK/RR)
- End profile for box KAP and aluminium angle see section 3

Stock service only for mill-finished boxes.

	RR	OT	VB 90°	RS RK
size	A	B	C	D
165	168	168	168	46
180	184	184	184	47
205	209	209	209	71

available colours with colour no.

00 mill-finished

standard colours (no RAL)

ELOX

41 silver anod. EV 1 55 bronze anod. C 33
51 bronze anod. BC 4

RAL

99 RAL (without protection film)

List of articles including prices in €/m

description	part number + colour number (...)	packing unit m	mill-finished	standard colours	silver anod.	bronze anod.	RAL
OT 165	0116510..	30					
VB 90° 165	0116520..	30			---	---	
RS RK 165 20°/90°	7303165..	30			---	---	
RR o.T. 165	0116531..	30					
OT 180	0118010..	12					
VB 90° 180	0118020..	12			---	---	
RS RK 180 20°/90°	7303180..	12			---	---	
RR o.T. 180	0118031..	12					
OT 205	0120510..	12					
VB 90° 205	0120520..	12			---	---	
RS RK 205 20°/90°	7303205..	12			---	---	
RR o.T. 205	0120531..	12					

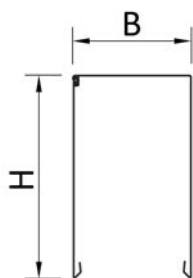

- made of roll formed aluminium
- powder-coated
- without protection film
- two-parts (L-box / RR)

Stock service only for mill-finished boxes.

size	H	B
200	200	140
240	240	140
300	300	140

available colours with colour no.

00 mill-finished

standard colours (no RAL)

RAL

99 RAL (without protection film)

List of articles including prices in €/m

description	part number + colour number (...)	packing unit m	mill-finished	RAL
RS L 200	0420060..	4		
RS RR 200	0420070..	4		
RS L 240	0424060..	4		
RS RR 240	0424070..	4		
RS L 300	0430060..	4		
RS RR 300	0430070..	4		

PRESSURE MOULDED END CAPS FOR FRONT-MOUNTED ELEMENTS WITH EXTERIOR BLINDS

ALUKON

BEVELLED VERSION 20°

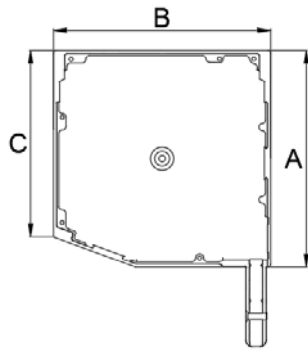

- made of special aluminium alloy
- pressure moulded (cannot be anodized)
- for front-mounted exterior blinds with or without insect repelling system

size	A	C
165	168	145
180	184	156
205	210	179

available colours with colour no.

00 mill-finished

standard colours (no RAL)

RAL

99 RAL

List of articles including prices in €/pair

description	part number + colour number (...)	packing unit pair	mill-finished	standard colours	RAL
BKS-RS-N 165 20°	2316210..	10			
BKS-RS-N 180 20°	2318210..	10			
BKS-RS-N 205 20°	2320210..	10			

PRESSURE MOULDED END CAPS FOR FRONT-MOUNTED ELEMENTS WITH EXTERIOR BLINDS

ALUKON

BEVELLED VERSION 45°

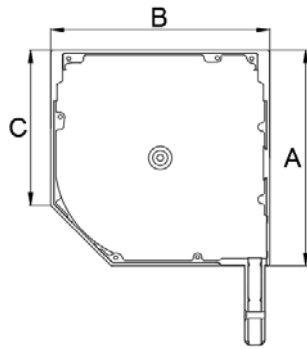

- made of special aluminium alloy
- pressure moulded (cannot be anodized)
- for front-mounted exterior blinds with or without insect repelling system

size	A	C
165	169	121
180	184	133
205	209	151

available colours with colour no.

00 mill-finished

standard colours (no RAL)

RAL

99 RAL

List of articles including prices in €/pair

description	part number + colour number (...)	packing unit pair	mill-finished	standard colours	RAL
BKS-RS-N 165 45°	2316250..	10			
BKS-RS-N 180 45°	2318250..	10			
BKS-RS-N 205 45°	2320250..	10			

PRESSURE MOULDED END CAPS FOR FRONT-MOUNTED ELEMENTS WITH EXTERIOR BLINDS

ALUKON

RECTANGULAR VERSION 90°

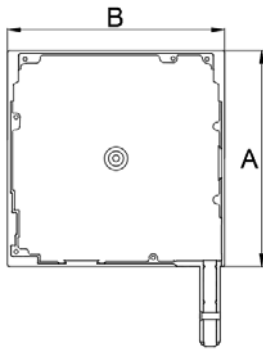

- made of special aluminium alloy
- pressure moulded (cannot be anodized)
- for front-mounted exterior blinds with or without insect repelling system

size	A
165	168
180	184
205	209

available colours with colour no.

00 mill-finished

standard colours (no RAL)

RAL

99 RAL

List of articles including prices in €/pair

description	part number + colour number (...)	packing unit pair	mill-finished	standard colours	RAL
BK-RS-N 165 90°	2316220..	10			
BK-RS-N 180 90°	2318220..	10			
BK-RS-N 205 90°	2320220..	10			

PRESSURE MOULDED END CAPS FOR FRONT-MOUNTED ELEMENTS WITH EXTERIOR BLINDS

ALUKON

ROUND VERSION

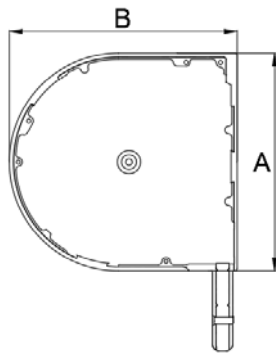

- made of special aluminium alloy
- pressure moulded (cannot be anodized)
- for front-mounted exterior blinds with or without insect repelling system

size	A	B
165	169	176
180	183	191
205	210	219

available colours with colour no.

00 mill-finished

standard colours (no RAL)

RAL

99 RAL

List of articles including prices in €/pair

description	part number + colour number (...)	packing unit pair	mill-finished	standard colours	RAL
BKR-RS-N 165	2316230..	10			
BKR-RS-N 180	2318230..	10			
BKR-RS-N 205	2320230..	10			

PRESSURE MOULDED END CAPS FOR RAFF-E

ALUKON

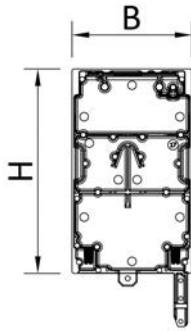

- made of a special aluminium alloy
- pressure moulded (cannot be anodized)
- for Raff-E with and without insect repelling system

BK-RS-E			
size	H	B	
200	200	---	140
240	240	125	140
300	300	125	140

available colours with colour no.

00 mill-finished



standard colours (no RAL)

RAL

99 RAL

List of articles including prices in €/pair

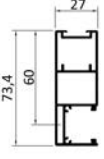
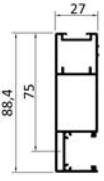
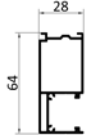
description	part number + colour number (...)	packing unit pair	mill-finished	standard colours	RAL
BK-RS-E 200	2320260..	5			
BK-RS-E 240	2324260..	5			
BK-RS-E 300	2330260..	5			
BK-RS-E 240x125	2324360..	5	Ab 01.06. verfügbar	Ab 01.06. verfügbar	Ab 01.06. verfügbar
BK-RS-E 300x125	2330360..	5	Ab 01.06. verfügbar	Ab 01.06. verfügbar	Ab 01.06. verfügbar

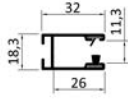
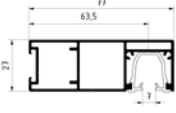
	Product description	article no.	p.u. m	Unit	price €
	RS A 44				
	mill-finished	734100400	30	m	
	standard colours	7341004..	30	m	
	RAL	734100499	30	m	
	Extra charge protection film single-sided	739910710		m	
	RS A 45				
	mill-finished	734100500	30	m	
	standard colours	7341005..	30	m	
	RAL	734100599	30	m	
	RS A 47RS A 47 Further components can be found in chapter 5.9 under fall protection.				
	mill-finished	734101500	5,2	m	
	standard colours	7341015..	5,2	m	
	RAL	734101599	5,2	m	
	A 40 Guidance made of PVC				
	black	734101000	30	m	
	A 22 Insect repelling guidance in combination with RS FS A 45, without insert				
	mill-finished	734101800	60	m	
	white	7341018..	60	m	
	RAL	734101899	60	m	
		739912800		m	
	RS A 49 (RAFF-E T 125) *				
	mill-finished	734101700	30	m	---
	standard colours	7341017..	30	m	---
	RAL	734101799	30	m	---

A 22: Pay attention to the built in direction: diagonal brush showing to the window - thick brush outwards.



*available from 01.06.2025.





	Product description	article no.	p.u. m	Unit	price €
	Support 10 mm				
	mill-finished	115010000	60	m	
	standard colours	1150100..	60	m	
	RAL	115010099	60	m	
	Support 20 mm				
	mill-finished	115020000	60	m	
	standard colours	1150200..	60	m	
	RAL	115020099	60	m	
	Support profile 40 mm				
	mill-finished	115040000	60	m	
	standard colours	1150400..	60	m	
	RAL	115040099	60	m	
	Guide channel end part A 44, black				
	Rectangular	734109020	50	pair	
	Bevelled 5°	734109220	50	pair	
	Guide channel end part A 45, black				
	Rectangular	734109120	50	pair	
	Bevelled 5°	734109320	50	pair	
	conclusion guide rail A49 black*				
	Rectangular	734108120	50	pair	---
	Bevelled 5°	734108220	50	pair	---









* available from 01.06.2025.

ACCESSORIES FOR EXTERIOR BLIND GUIDE CHANNELS

ALUKON

	Product description	article no.	p.u. m	Unit	price €
	Insert black for RS guide channel	739000100	400	m	
	Extra charge for inserts in small quantities (per piece)				
	Extra charge for brushes and inserts in small quantities (per piece)	890000200		pce	
	Curtain saving, including screw	739000500	200	pce	
	Mounting plate A 22				
	138 left, galvanized incl. stopper	316030100	5	pce	
	138 right, galvanized incl. stopper	316030200	5	pce	
	150 left, galvanized incl. stopper	316030300	5	pce	
	150 right, galvanized incl. stopper	316030400	5	pce	
	165 left, galvanized incl. stopper	316030500	5	pce	
	165 right, galvanized incl. stopper	316030600	5	pce	
	180 left, galvanized incl. stopper	316030700	5	pce	
	180 right, galvanized incl. stopper	316030800	5	pce	
	205 left, galvanized incl. stopper	316030900	5	pce	
	205 right, galvanized incl. stopper	316031000	5	pce	

	Product description	article no.	p.u. m	Unit	price €
	End slat RS-80				
	mill-finished	734500400	60	m	
	standard colours	7345004..	60	m	
	RAL	734500499	60	m	
	End cap open				
	black for guide channel installation	739001400	100	pce	
	End cap pin				
	black	739001800	200	pce	
	Tape holder				
		739002300	250	pce	

	Product description	article no.	p.u. m	Unit	price €
	RS Box locking system				
	black	739002000	50	pair	
	RS Connector for A 40				
	black	739002100	100	pce	
	RS Guide terminal insect repelling system				
	black	739002200	50	pair	
	Box holder, galvanized				
	200-240	739012100	25	pce	
	200-300	739012200	25	pce	
	Adjustable lug				
	Galvanized	739012300	100	pce	
	Embossing pliers for external venetian blinds				
		891410900	1	pce	
	Repair kit for guide nipple 80 mm lath				
	Set consists of: 10 guide nipples and 20 rivets	891410910	1	pce	
	cover bracket T125				
	125/240-300	739012420	25	pce	

For integrated insect repelling system parts please refer to section 13.

18 AUFSATZPROGRAMM

AK-MIRO PLUS AUS PVC

Caissons bloc-baie AK-E EasyBox et AK-MIRO PLUS en PVC et accessoires

Top-mounted shutter portfolio AK-E EasyBox and AK-MIRO PLUS out of PVC and accessories

Nadoken. systémy z PVC AK-E EasyBox a AK-MIRO PLUS a příslušenství

System rolet nasadkowych z PCV AK-E EasyBox i AK-MIRO PLUS



PVC opbouwkasten AK-E EasyBox en AK-MIRO PLUS met toebehoren

Felsötökös AK-MIRO PLUS PVC-böl

BOX KITS AND FRONT COVERS

FOR AK-MIRO PLUS

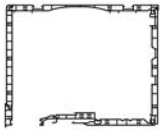
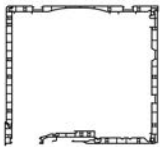
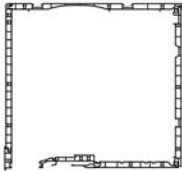





ALUKON

	Product description	article no.	p.u. m	Unit	price €
	Box kit MIRO+ size 175				
	white, 4-sided	711175101	6	m	
	DB 703	711175118	6	m	
	22 golden oak 54 charcoal smooth 57 charcoal grained	7111751..	6	m	
	white, 3-sided	711175001	6	m	
	Box kit MIRO+ size 200				
	white, 4-sided	711200101	6	m	
	DB 703	711200118	6	m	
	22 golden oak 54 charcoal smooth 57 charcoal grained	7112001..	6	m	
	white, 3-sided	711200001	6	m	
	Box kit MIRO+ size 240				
	white, 4-sided	711240101	6	m	
	DB 703	711240118	6	m	
	22 golden oak 54 charcoal smooth 57 charcoal grained	7112401..	6	m	
	white, 3-sided	711240001	6	m	
	Front cover MIRO+ made of PVC				
	size 175 white	711150201	6	m	
	DB 703	711150218	6	m	
	22 golden oak 54 charcoal smooth 57 charcoal grained	7111502..	6	m	
	size 200 white	711181201	6	m	
	DB 703	711181218	6	m	
	22 golden oak 54 charcoal smooth 57 charcoal grained	7111812..	6	m	
	size 240 white	711220201	6	m	
	DB 703	711220218	6	m	
22 golden oak 54 charcoal smooth 57 charcoal grained	7112202..	6	m		
	Front cover MIRO+ made of aluminium				
	size 175 mill-finished	710175100	6	m	
	Size 175 standard colours	7101751..	6	m	
	size 175 RAL	710175199	6	m	
	size 200 mill-finished	710200100	6	m	
	Size 200 standard colours	7102001..	6	m	
	size 200 RAL	710200199	6	m	
	size 240 mill-finished	710240100	6	m	
	Size 240 standard colours	7102401..	6	m	
size 240 RAL	710240199	6	m		

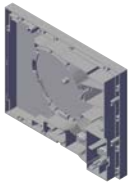
HEAD PIECES AND ACCESSORIES

FOR AK-MIRO PLUS





ALUKON

	Product description	article no.	p.u. m	Unit	price €
	Head pieces V2 MIRO+				
	size 175 white	718500401	28	pair	
	size 175 brown	718500402	28	pair	
	size 200 white	718500501	25	pair	
	size 200 brown	718500502	25	pair	
	size 240 white	718500601	18	pair	
	size 240 brown	718500602	18	pair	
	Bearing plate for MIRO+				
	black	718501100	100	pce	
	Bolt for bearing plate V2 for MIRO+				
	Red (price per 100 pieces)	718501210	100	pce	
	Distance ring for bearing plate for MIRO+				
	Red (price per 100 pieces)	718501300	100	pce	
	Cable clip for MIRO+				
	Red (price per 100 pieces)	718501400	100	pce	
	Head piece adapter MIRO+ for insect repelling system				
	revision inside	718501500	25	pair	

GUIDE TERMINAL VERSIONS AND COVER

FOR AK-MIRO PLUS



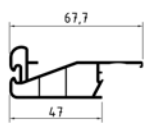

ALUKON

	Product description	article no.	p.u. m	Unit	price €
	Guide terminal for bottom and inside access for MIRO+				
	revision inside guide channel 51 mm white	718502100	50	pair	
	guide terminal MIRO +				
	outside revision, white	718502200	50	pair	
	guide terminal MIRO +				
	Venetian blinds, white	718502300	50	pair	
	Trench covering for box extension for MIRO+				
	size 175/200 white	718507101	100	pce	
	size 175/200 brown	718507102	100	pce	
	size 240 white	718507201	100	pce	
	size 240 brown	718507202	100	pce	
	winding profile revision outside				
	white	711901301	6	m	
	black	711901390	6	m	

INSULATION, STOP LEDGE, PLASTER BASE BOARD STATIC CONSOLE

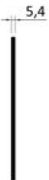
ALUKON

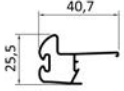
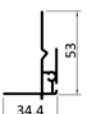
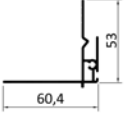



FOR AK-MIRO PLUS





	Product description	article no.	p.u. m	Unit	price €
	Insulation for MIRO+ two-parts L = 1,25 m				
	size 175	718603100	32	pce	
	size 200	718603200	28	pce	
	size 240	718603300	17	pce	
	MIRO+ absorbing mat				
	1000 x 500 x 5,4 mm	718021800	1	pce	
	Insulation for head piece MIRO+				
	size 175	718602400	100	pce	
	size 200	718602500	100	pce	
	size 240	718602600	100	pce	
	Standard stop ledge for MIRO+				
	white	711900301	6	m	
	DB 703	711900318	6	m	
	22 golden oak 54 charcoal smooth 57 charcoal grained	7119003..	6	m	
	roller rail, interior revision for MIRO+				
	white	711901201	6	m	
	black	711901290	6	m	
	24 mm plaster base board MIRO+ outside, made from aluminium				
	mill-finished	712700100	30	m	
	white mat 9016	712700126	30	m	
	RAL	712700199	30	m	
	50 mm plaster base board MIRO+ outside, made from aluminium				
	mill-finished	712700300	30	m	
	white mat 9016	712700326	30	m	
	RAL	712700399	30	m	
	Static console MIRO+				
	Size 175 for bottom access	718150100	1	pce	
	Size 200 for bottom access	718150200	1	pce	
	Size 240 for bottom access	718150300	1	pce	
	Size 240 for outside access	718150400	1	pce	
	Size 240 for exterior blinds	718150500	1	pce	



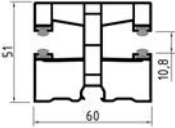

ADAPTER PROFILES, SPECIAL REINFORCEMENT IRONS AND MODULAR GRIDS

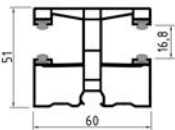
ALUKON

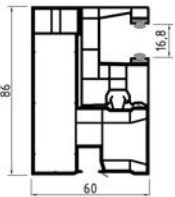
FOR AK-MIRO PLUS

	Product description	article no.	p.u. m	Unit	price €
	Adapter profiles for MIRO+ made from PVC				
	Universal 1	712202700	60	m	
	Universal 2	712202800	60	m	
	Aluplast 70, 80, 85 mm, Drutex 70 mm	712202200	60	m	
	Brüggmann 73, 82 mm, Salamander 82 mm	712201100	60	m	
	Salamander 76, 92 mm, Brüggmann 92 mm	712202100	60	m	
	Deceunick 70 mm	712203100	60	m	
	Gealan 74, 83 mm	712201300	60	m	
	Inoutic 71 mm	712202600	60	m	
	Inoutic 76 mm	712202400	60	m	
	Inoutic 84 mm	712203300	60	m	
	KBE 70 mm	712201500	60	m	
	Kömmerling 70 mm	712201700	60	m	
	Trocal, Kömmerling, KBE 76, 88 mm	712203200	60	m	
	Rehau 70, 80, 86 mm	712201900	60	m	
	Schüco 70 mm	712201400	60	m	
	Schüco 82 mm	712202300	60	m	
	Veka 70, 76, 82, 90 mm	712203000	60	m	
	Special reinforcement iron MIRO+				
	Standard (Iy = 8,30)	712400200	6	m	
	HST (Iy = 2,43)	712400300	6	m	
	Modular grid for MIRO+ in combination with reinforcement iron				
	Aluplast 70, 80, 85 mm, Drutex 70 mm, HST Aluplast 167 mm	712301200	100	pce	
	Brüggmann 73, 82 mm, Salamander 82 mm	712300300	100	pce	
	Salamander 76, 92 mm, Brüggmann 92 mm, HST Salamander 172 mm	712301100	100	pce	
	Deceunick 70 mm	712302200	100	pce	
	Gealan 74, 83 mm	712300500	100	pce	
	Gealan 83 mm (S9000)	712302500	100	pce	
	Inoutic 71 mm	712301600	100	pce	
	Inoutic 76 mm, HST Inoutic 175 mm	712301700	100	pce	
	Inoutic 84 mm	712302400	100	pce	
	KBE 70 mm	712300600	100	pce	
	Kömmerling 70 mm	712300800	100	pce	
	Trocal, Kömmerling, KBE 76, 88 mm, HST Profine 179 mm	712302300	100	pce	
	Rehau 70, 80, 86 mm, HST Rehau 203 mm	712300900	100	pce	
	Schüco 70, 82 mm, HST Schüco 167, 194 mm	712301300	100	pce	
	Schüco 80 mm	712301400	100	pce	
	Trocal 70 mm	712301800	100	pce	
	Veka 70 mm	712302100	100	pce	

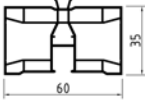
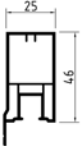
	Product description	article no.	p.u. m	Unit	price €
	K 70 Mini, PVC, with brush				
	white	763017001	6	m	
	DB 703	763017018	6	m	
	22 golden oak 54 charcoal smooth 57 charcoal grained	7630170..	6	m	
	DF K 70 Mini, PVC, with brush				
	white	763019001	6	m	
	DB 703	763019018	6	m	
	22 golden oak 54 charcoal smooth 57 charcoal grained	7630190..	6	m	
	K 70 Maxi, PVC, with brush				
	white	763018001	6	m	
	DB 703	763018018	6	m	
	22 golden oak 54 charcoal smooth 57 charcoal grained	7630180..	6	m	
	DF K 70 Maxi, PVC, with brush				
	white	763020001	6	m	
	DB 703	763020018	6	m	
	22 golden oak 54 charcoal smooth 57 charcoal grained	7630200..	6	m	
	K 74 Mini, PVC with brush				
	white	763025001	6	m	
	DB 703	763025018	6	m	
	22 golden oak 54 charcoal smooth 57 charcoal grained	7630250..	6	m	
	K 74 Maxi, PVC with brush				
	white	763026001	6	m	
	DB 703	763026018	6	m	
	22 golden oak 54 charcoal smooth 57 charcoal grained	7630260..	6	m	

	Product description	article no.	p.u. m	Unit	price €
	K 73, Mini, PVC wiht brush (insect repellent not possible)				
	white	763028001	6	m	
	DB 703	763028018	6	m	
	22 golden oak 54 charcoal smooth 57 charcoal grained	7630280..	6	m	
	K 73, Maxi, PVC wiht brush (insect repellent not possible)				
	white	763029001	6	m	
	DB 703	763029018	6	m	
	22 golden oak 54 charcoal smooth 57 charcoal grained	7630290..	6	m	
	aluminium guide channel with insect protection, without inlay, for top-mounted box, snap-on, for PVC guide channels				
	mill-finished	713080500	30	m	
	white mat 9016	713080526	30	m	
	black 9005 Mat	713080590	30	m	
	RAL Extra charge diagonal + thick brush	713080599 719912800	30 30	m m	
	K 70 adapterfor outside revision				
	white	763027001	6	m	
	DB 703	763027018	6	m	
	22 golden oak 54 charcoal smooth 57 charcoal grained	7630270..	6	m	
	Guide channel cover PVC 46 mm for venetian blinds clinker brick (not available from stock - please note extended delivery time)				
	white	763026501	6	m	
	DB 703	763026518	6	m	
	22 golden oak 54 charcoal smooth 57 charcoal grained	7630265..	6	m	
	Cover PVC 7 mm for venetian blinds clinker brick (not available from stock - please note extended delivery time)				
	white	763026601	60	m	
	DB 703	763026618	60	m	
	22 golden oak 54 charcoal smooth 57 charcoal grained	7630266..	60	m	

ALUMINIUM GUIDE CHANNELS AND GUIDE CHANNEL ACCESSORIES

ALUKON

FOR AK-MIRO PLUS

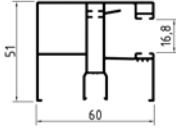
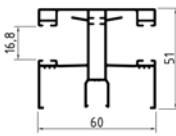
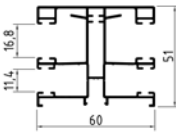
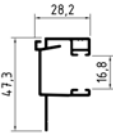
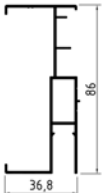
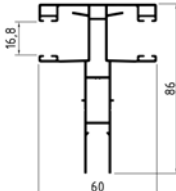
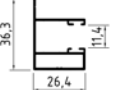



	Product description	article no.	p.u. m	Unit	price €
	A 70 aluminium				
	mill finished	763048000	6	m	
	standard colours	7630480..	6	m	
	RAL	763048099	6	m	
	DF A70 aluminium				
	mill finished	763037000	6	m	
	standard colours	7630370..	6	m	
	RAL	763037099	6	m	
	DF A 71 aluminium with groove for insect repelletion				
	mill finished	763038000	6	m	
	standard colours	7630380..	6	m	
	RAL	763038099	6	m	
	A 74, aluminium				
	mill finished	763041000	6	m	
	standard colours	7630410..	6	m	
	RAL	763041099	6	m	
	A 74 adapter, aluminium				
	mill finished	763042000	6	m	
	standard colours	7630420..	6	m	
	RAL	763042099	6	m	
	DF A 74, aluminium#				
	mill finished	763043000	6	m	
	standard colours	7630430..	6	m	
	RAL	763043099	6	m	
	A 24, aluminium insect groove for outside revision/Venetian Blinds				
	mill finished	763044000	6	m	
	standard colours	7630440..	6	m	
	RAL	763044099	6	m	

ALUMINIUM GUIDE CHANNELS AND GUIDE CHANNEL ACCESSORIES

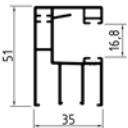
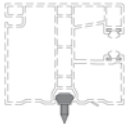
ALUKON

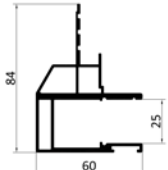
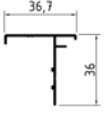
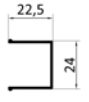
FOR AK-MIRO PLUS

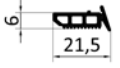
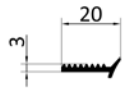
	Product description	article no.	p.u. m	Unit	price €
	A 73, aluminium				
	mill finished	763040000	6	m	
	standard colours	7630400..	6	m	
	RAL	763040099	6	m	
	Plug connection for MIRO+ for PVC and aluminium guide channels				
		713900200	1000	pce	





	Product description	article no.	p.u. m	Unit	price €
	A 76-GS aluminium length 520 cm				
	mill finished	763046000	5,2	m	
	standard colours	7630460..	5,2	m	
	RAL	763046099	5,2	m	
	A 76 adapter, aluminium, length 520 cm				
	mill finished	763047000	5,2	m	
	standard colours	7630470..	5,2	m	
	RAL	763047099	5,2	m	
	cover for A 17-GS				
	mill-finished	810003000	6	m	
	standard colours	8100030..	6	m	
	RAL	810003099	6	m	
	edge protection 21 x 10				
	mill-finished	810003200	6	m	
	silver anodized EV 1	810003241	6	m	
	glas seal insert				
	TPE black	810080002	100	m	
	glas seal self-adhesive (double barrelled)				
	EPDM black	810080003	100	m	
	glas support				
	black	810080001	1	pair	

Anti-fall protection for built-on systems see p.5.9

INSERTS FOR ALUMINIUM GUIDE CHANNELS, VENETIAN BLINDS INSERTS, SURCHARGES

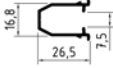
ALUKON



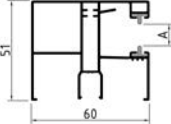

FOR AK-MIRO PLUS

	Product description	article no.	p.u. m	Unit	price €
	K 75 plastic guide channel for venetian blinds, for PVC and aluminium guide channel				
	black	763901000	6	m	
	AK-F insert 3,7 mm for aluminium guide channels with M521/KM521				
	black	763901200	250	m	
	AK-F insert 5,4 mm for aluminium guide channels with MY 442 (base with yellow marking)				
	black	763901300	250	m	
	AK-F insert 6,2 mm for aluminium guide channels with M 3217/KM 317				
	black	763901400	250	m	
	Surcharge for guide channels with built-in insert 2 x insert 3,7 mm A = 14,4 mm 2 x insert 5,4 mm A = 11 mm 2 x insert 6,2 mm A = 9,4 mm				
	Surcharge insert one-sided (GC)	769912900		0	
	Surcharge brush two-sided (GC)	769913200		0	
	Surcharge for guide channel with built-in insect brush (inclined brush and thick brush)				
	Surcharge brush one-sided (GC)	769912800		0	
	Surcharge brush two-sided (GC)	769913100		0	
	Surcharge for guide channels with protection foil for A 70, DF A 71, DF A 72, D 73, DF A 74				
	Surcharge protection foil	769910700		0	

PULLEYS AND COUNTER PLATES

FOR AK-MIRO PLUS

ALUKON

	Product description	article no.	p.u. m	Unit	price €
	Pulley for MIRO+ for 40 mm and 60 mm shaft with 14 mm tape				
	size 175	718201100	100	pce	
	size 200	718201200	100	pce	
	size 240	718201300	100	pce	
	Pulley for MIRO+ for 60 mm shaft with 23 mm tape				
	size 200 (for displaced inlet)	718201500	100	pce	
	Pulley new building 170 mm for 60 mm shaft	267011700	1	pce	
	size 240			pce	
	Pulley for tape gear 2:1 for 14 mm tape (for box size 200 and 240)				
	Pulley 140 mm	240110200	1	pce	
	Pulley 165 mm	240110400	1	pce	
	Counter plate for MIRO+				
	size 175, two-parts, white	718503100	25	pce	
	size 200, two-parts, white	718503200	25	pce	
	size 240, two-parts, white	718503300	25	pce	
	Counter plate for MIRO+ for displaced inlet				
	size 175, two-parts, white	718503500	25	pce	
	size 200, two-parts, white	718503600	25	pce	
	size 240, two-parts, white	718503700	25	pce	

ACCESSORIES FOR TOP-MOUNTED BOX SYSTEM

FOR AK-MIRO PLUS



ALUKON

	Product description	article no.	p.u. m	Unit	price €
	Tape guides for MIRO+				
	for tape white 14 mm	718030100	100	pce	
	for tape brown 14 mm	718030200	100	pce	
	Tape guide for new building sector with brush				
	white	289120100	100	pce	
	brown	289120200	100	pce	
	Ball bearing for MIRO+				
		718301200	100	pce	
	Roller cap for MIRO+				
	for shaft 40 mm	718301300	100	pce	
	for shaft 60 mm	718301400	100	pce	
	Mounting lug				
	left	767010100	50	pce	
	right	767010200	50	pce	
	Screw-in anchor for MIRO+				
	Steel	718302500	200	pce	
	Tape gear 2:1 without pulley for MIRO+				
	Tape gear 2:1 without pulley	240110000	1	pce	
	Roller cap for tape gear 2:1, 40 mm shaft				
	PVC roller cap	240110900	1	pce	

ACCESSORIES FOR TOP-MOUNTED BOX SYSTEM

FOR AK-MIRO PLUS

ALUKON

	Product description	article no.	p.u. m	Unit	price €
	AK-F guide channel closing inlay Mini for roller curtain for PVC guide channels Mini				
	stainless V2A	763901500	20	pce	
	AK-F guide channel closing inlay Maxi/alu for roller curtain for PVC guide channels Maxi and aluminium guide channels				
	stainless V2A	763901600	20	pce	

ACCESSORIES FOR COMBINATIONS



FOR AK-MIRO PLUS

ALUKON

	Product description	article no.	p.u. m	Unit	price €
	Central piece for MIRO+ for coupling/division				
	size 175, black	718504100	25	pce	
	size 200, black	718504200	25	pce	
	size 240, black	718504300	14	pce	
	Central piece for MIRO+ for displaced inlet				
	size 175, black	718506100	25	pce	
	size 200, black	718506200	25	pce	
	size 240, black	718506300	14	pce	
	Central support for MIRO+ for division				
	white	718505100	50	pce	
	Central support for MIRO+ for coupling				
	white	718505200	50	pce	
	Spacer for MIRO+ displaced coupling				
	black	718102500	100	pce	
	Double shaft bolt for MIRO+				
	for shaft 40 mm	718301900	20	pce	
	for shaft 60 mm	718302100	20	pce	



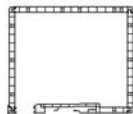
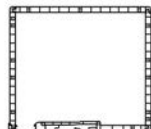
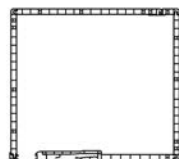

BOX KITS AND FRONT COVERS FOR EASYBOX MIRO-E

ALUKON

	Product description	article no.	p.u. m	Unit	price €
	Box kit MIRO-E size 150				
	white, 4-sided	711150101	6	m	
	golden oak, charcoal, standard design 4-sided	7111501..	6	m	
	white, 3-sided	711150001	6	m	
	Box kit MIRO-E size 181				
	white, 4-sided	711181101	6	m	
	golden oak, charcoal, standard design 4-sided	7111811..	6	m	
	white, 3-sided	711181001	6	m	
	Box kit MIRO-E size 220				
	white, 4-sided	711220101	6	m	
	golden oak, charcoal, walnut, standard design 4-sided	7112201..	6	m	
	white, 3-sided	711220001	6	m	
	PVC front covers MIRO-E				
	size 175 white	711150201	6	m	
	size 175 salamander white	711150210	6	m	
	22 golden oak 54 charcoal smooth 57 charcoal grained	7111502..	6	m	
	size 200 white	711181201	6	m	
	size 200 salamander white	711181210	6	m	
	22 golden oak 54 charcoal smooth 57 charcoal grained	7111812..	6	m	
	size 240 white	711220201	6	m	
	size 240 salamander white	711220210	6	m	
22 golden oak 54 charcoal smooth 57 charcoal grained	7112202..	6	m		
	Aluminium front covers MIRO-E				
	Size 150 mill-finished	711150900	6	m	
	size 150 RAL	711150999	6	m	
	size 181 mill-finished	711181900	6	m	
	size 181 RAL	711181999	6	m	
	size 220 mill-finished	711220900	6	m	
size 220 RAL	711220999	6	m		

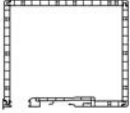

HEAD PIECES FOR EASYBOX MIRO-E

ALUKON

	Product description	article no.	p.u. m	Unit	price €
	Head pieces MIRO-E				
	size 150 white	718000101	40	pair	
	size 150 brown	718000102	40	pair	
	size 181 white	718000201	30	pair	
	size 181 brown	718000202	30	pair	
	size 220 white	718000301	24	pair	
	size 220 brown	718000302	24	pair	
	Head pieces MIRO-E for integrated insect repelling system (for required adapter please see section 18)				
	size 150 white	718002101	40	pair	
	size 150 brown	718002102	40	pair	
	size 181 white	718002201	30	pair	
	size 181 brown	718002202	30	pair	
	size 220 white	718002301		0	
	size 220 brown	718002302	16	pair	
	Guide terminal MIRO-E				
	black	718009100	250	pair	
	Slider MIRO-E				
	PVC	718102100	100	pce	

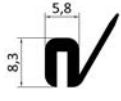

INSULATION, STOP LEDGE, PLASTER BASE BOARD FOR EASYBOX MIRO-E

ALUKON

	Product description	article no.	p.u. m	Unit	price €
	Insulation for MIRO-E, one-piece L= 1,25 m				
	size 150	718020100	44	pce	
	size 181	718020200	33	pce	
	size 220	718020300	18	pce	
	Joint sealing for MIRO-E				
	black	718029100	100	m	
	Stop ledge for MIRO-E				
	white	711900101	6	m	
	salamander white	711900110	6	m	
	golden oak, mahogany, charcoal, walnut, bog oak, standard design 4-sided	711900122	6	m	

ADAPTER PROFILES, SPECIAL REINFORCEMENT IRONS AND MODULAR GRIDS FOR EASYBOX MIRO-E

ALUKON

	Product description	article no.	p.u. m	Unit	price €
	Adapter profiles for MIRO-E made from PVC				
	Universal 1	712202700	60	m	
	Universal 2	712202800	60	m	
	Aluplast 70, 80, 85 mm, Drutex 70 mm	712202200	60	m	
	Brüggmann 73, 82 mm, Salamander 82 mm	712201100	60	m	
	Salamander 76, 92 mm, Brüggmann 92 mm	712202100	60	m	
	Deceunick 70 mm	712203100	60	m	
	Gealan 74, 83 mm	712201300	60	m	
	Inoutic 71 mm	712202600	60	m	
	Inoutic 76 mm	712202400	60	m	
	Inoutic 84 mm	712203300	60	m	
	KBE 70 mm	712201500	60	m	
	Kömmerling 70 mm	712201700	60	m	
	Trocal, Kömmerling, KBE 76, 88 mm	712203200	60	m	
	Rehau 70, 80, 86 mm	712201900	60	m	
	Schüco 70 mm	712201400	60	m	
	Schüco 82 mm	712202300	60	m	
Veka 70, 76, 82, 90 mm	712203000	60	m		
	Special reinforcement iron MIRO-E				
	for MIRO-E	712400100	6	m	
	Modular grid for MIRO-E in combination with reinforcement iron				
	Aluplast 70, 80, 85 mm, Drutex 70 mm, HST Aluplast 167 mm	712301200	100	pce	
	Brüggmann 73, 82 mm, Salamander 82 mm	712300300	100	pce	
	Salamander 76, 92 mm, Brüggmann 92 mm, HST Salamander 172 mm	712301100	100	pce	
	Deceunick 70 mm	712302200	100	pce	
	Gealan 74, 83 mm	712300500	100	pce	
	Gealan 83 mm (S9000)	712302500	100	pce	
	Inoutic 71 mm	712301600	100	pce	
	Inoutic 76 mm, HST Inoutic 175 mm	712301700	100	pce	
	Inoutic 84 mm	712302400	100	pce	
	KBE 70 mm	712300600	100	pce	
	Kömmerling 70 mm	712300800	100	pce	
	Trocal, Kömmerling, KBE 76, 88 mm, HST Profine 179 mm	712302300	100	pce	
	Rehau 70, 80, 86 mm, HST Rehau 203 mm	712300900	100	pce	
	Schüco 70, 82 mm, HST Schüco 167, 194 mm	712301300	100	pce	
	Schüco 80 mm	712301400	100	pce	
	Trocal 70 mm	712301800	100	pce	
Veka 70 mm	712302100	100	pce		

PVC GUIDE CHANNELS FOR EASYBOX MIRO-E

	Product description	article no.	p.u. m	Unit	price €
	PVC guide channel MIRO-E for mini profiles including brush insert				
	white	713010101	6	m	
	golden oak, charcoal, standard design	7130101..	6	m	
	PVC guide channel MIRO-E for 52 mm maxi profiles including brush insert				
	white	713010201	6	m	
	golden oak, charcoal, standard design	7130102..	6	m	
	PVC double guide channel MIRO+ DF for mini profiles including brush insert				
	white	713010501	6	m	
	golden oak, charcoal, standard design	7130105..	6	m	
	PVC double guide channel MIRO-E DF for 52 mm maxi profiles including brush insert				
	white	713010601	6	m	
	golden oak, charcoal, standard design	7130106..	6	m	
	PVC double guide channel MIRO-E DF-IS for mini profiles and integrated insect repelling system including brush insert in rail groove				
	white	713020501	6	m	
	golden oak, charcoal, standard design	7130205..	6	m	
	PVC double guide channel MIRO-E DF-IS for 52 mm maxi profiles and integrated insect repelling system including brush insert in rail groove				
	white	713020601	6	m	
	golden oak, charcoal, standard design	7130206..	6	m	

ALUMINIUM GUIDE CHANNELS FOR EASYBOX MIRO-E

ALUKON

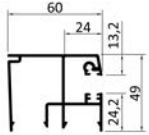
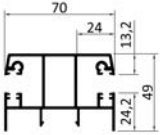
	Product description	article no.	p.u. m	Unit	price €
	Aluminium guide channel MIRO-E for mini profiles				
	mill-finished without insert	713080100	6	m	
	RAL without insert	713080199	6	m	
	Aluminium double guide channel MIRO-E DF for mini profiles				
	mill-finished without insert	713080300	6	m	
	RAL without insert	713080399	6	m	



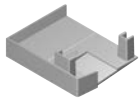
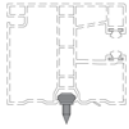
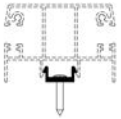

GUIDE CHANNEL ACCESSORIES FOR EASYBOX MIRO-E

ALUKON

	Product description	article no.	p.u. m	Unit	price €
	Guide channel end parts made of PVC for MIRO-E (for PVC and aluminium guide channels)				
	white	713900500	50	pair	
	brown	713900600	50	pair	
	white, for double guide channel	713900300	50	pce	
	brown, for double guide channel	713900400	50	pce	
	Plug connection for MIRO-E				
		713900200	1000	pce	
	Mounting clip MIRO-E				
	for aluminium guide channels	713900100	500	pce	





PULLEYS AND COUNTER PLATES FOR EASYBOX MIRO-E

ALUKON

	Product description	article no.	p.u. m	Unit	price €
	Pulley for MIRO-E for 40 mm and 60 mm shaft with 14 mm tape				
	size 175	718201100	100	pce	
	size 200	718201200	100	pce	
	size 240	718201300	100	pce	
	Counter plate for MIRO-E				
	size 150	718203900	100	pce	
	size 181	718204100	100	pce	
	size 220	718204200	100	pce	
	Counter plate for MIRO-E				
	size 150, for 40 mm shaft	718203100	250	pce	
	size 181, for 40 mm shaft	718203200	150	pce	
	size 181, for 60 mm shaft	718203300	150	pce	
	size 220, for 40 mm shaft	718203400	100	pce	
	size 220, for 60 mm shaft	718203500	100	pce	
	size 150, for 40 mm shaft	718203700	100	pce	
	size 181, for 40 mm shaft	718203800	100	pce	
	Stopper, A = 20 mm for MIRO-E with fixing screws				
	white	718304100	100	pce	
	black	718304200	100	pce	
	brown	718304300	100	pce	
	beige	718304400	100	pce	
	grey	718304500	100	pce	







ACCESSORIES FOR TOP-MOUNTED BOX SYSTEM FOR EASYBOX MIRO-E

ALUKON

	Product description	article no.	p.u. m	Unit	price €
	Tape guides for MIRO-E				
	for tape white 14 mm	718030100	100	pce	
	for tape brown 14 mm	718030200	100	pce	
	Ball bearing for MIRO-E				
		718301200	100	pce	
	Roller cap for MIRO-E				
	for shaft 40 mm	718301300	100	pce	
	for shaft 60 mm	718301400	100	pce	
	Mounting lugs for MIRO-E				
	MIRO-E	718302200	30	pce	

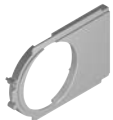



ACCESSORIES FOR COMBINATIONS FOR EASYBOX MIRO-E

ALUKON

	Product description	article no.	p.u. m	Unit	price €
	Bearing shell for MIRO-E for combinations				
	size 150, two-parts	718101100	20	pce	
	size 181 white, two-parts	718101200	15	pce	
	size 220, two-parts	718101300	7	pce	
	Bearing bolt for slider MIRO-E for combination with centered operation				
	steel, galvanized	718102200	10	pce	
	Bearing for 2-part combination MIRO-E for continuous shaft				
	PVC	718102600	25	pce	
	Bearing ring for MIRO-E for combinations with continuous shaft				
	for shaft 40 mm	718102700	25	pce	
	for shaft 60 mm	718102800	25	pce	
	Slider MIRO-E for displaced inlet				
	PVC	718102300	100	pce	
	Spacer for MIRO-E and AK-U.2 displaced coupling				
	black	718102500	100	pce	
	Screw sleeve for MIRO-E for bearing shell				
	PVC	718102400	100	pce	





ACCESSORIES FOR INSECT REPELLING SYSTEM FOR EASYBOX MIRO-E

ALUKON

	Product description	article no.	p.u. m	Unit	price €	
	Head piece adapter MIRO-E for integrated insect repelling system					
	size 150 white	718010101	20	pce		
	size 150 brown	718010102	20	pce		
	Head piece adapter MIRO-E for integrated insect repelling system					
	size 181 white	718010201	20	pce		
	size 181 brown	718010202	20	pce		
	Head piece adapter MIRO-E for integrated insect repelling system					
	size 220 white	718010301	20	pce		
	size 220 brown	718010302	20	pce		
	Central support for MIRO-E for coupling with integrated insect repelling system					
	size 150 for mini profile	718110000	1	pce		
	size 181 for mini profiles	718110100	1	pce		
	size 220 for mini profiles	718110200	1	pce		
	size 181 for maxi profiles 52 mm	718110600	1	pce		
	size 220 for maxi profiles 52 mm	718110700	1	pce		
	Central support for MIRO-E for division with integrated insect repelling system					
	size 150 for mini profile	718111000	1	pce		
	size 181 for mini profiles	718111100	1	pce		
	size 220 for mini profiles	718111200	1	pce		
	size 181 for maxi profiles 52 mm	718111600	1	pce		
size 220 for maxi profiles 52 mm	718111700	1	pce			

ACCESSORIES FOR INSECT REPELLING SYSTEM FOR EASYBOX MIRO-E

ALUKON

	Product description	article no.	p.u. m	Unit	price €
	adapter profile for MIRO-E for box with insect repelling system	711910100	120	m	
	Insect repelling end slat MIRO-E SLI (brush for groove below see page 14. 19 part no. 310135500 12,5 mm brush for ST)				
	mill-finished	714000100	24	m	
	white	7140001..	24	m	
	RAL	714000199	24	m	
	Stopper for MIRO-E SLI				
	black	714901100	10	pce	
	Cord with tassel for MIRO-E SLI				
	black	714901200	10	pce	
	Bolt for MIRO-E SLI				
	black	714901400	10	pair	

19 GESCHÄUMTER AUFSATZKASTEN

AK-FLEX UND RENOVIERUNGSKASTEN AK-FENRO

Caisson renovation avec mousse isolante AK-FLEX et AK-FENRO





Foamed top-mounted box AK-FLEX and renovation box AK-FENRO

Nadokenní polystyrenová schránka

Skrzynka nadprożowa naokienna

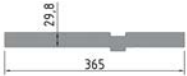
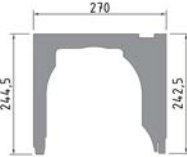
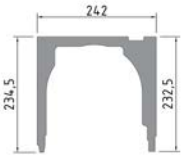

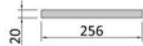

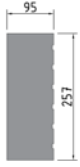
Geschuimde opbouwkast

Habbal töltött felsőépitésű tok AK-FLEX és AK-FENRO

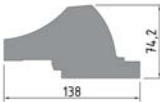
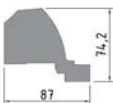

	Product description	article no.	p.u. m	Unit	price €
	AK-F.2 doubling, foamed above, grey 30x365 mm length 150 cm	760101020	1,5	m	
	AK-F U-cover 270 foamed, grey length 150 cm	760104000	1,5	m	
	AK-F U cover 240 foamed, grey length 150 cm	760105000	1,5	m	
	AK-F support inside, 10mm Length 150 cm	760501000	1,5	m	
	AK-F support inside, 20 mm Length 150 cm	760502000	1,5	m	
	AK-F inside doubling, foamed above, grey 30 mm for box depth 300 length 150 cm	760503000	1,5	m	
	AK-F inside doubling, foamed above, grey 30 mm for box depth 365 length 150 cm	760504000	1,5	m	

AK-FLEX.2 BOX COVERS FOR BOX 240, 270 AND CLINKER BOX

ALUKON

	Product description	article no.	p.u. m	Unit	price €
	AK-F.2 isolation wedge revision inside for guide channel 51 mm, grey length 150 cm	760401011	1,5	m	
	AK-F.2 isolation wedge revision inside for guide channel 35 mm, grey length 150 cm	760401012	1,5	m	
	AK-F.2 isolation wedge outside revision, grey length 150 cm	760402010	1,5	m	
	AK-F.2 isolation wedge venetian blind, grey length 150 cm	760403010	1,5	m	
	AK-F.2 isolation inlay venetian blind, grey length 150 cm	760404010	1,5	m	
	AK-F.2 filling block for corner solution, grey for outside revision or Venetian Blinds 27 x 27 x 26 cm	760900002	1	pce	

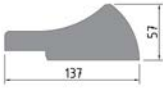

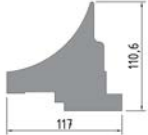
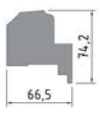

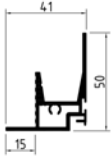
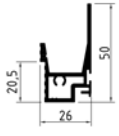
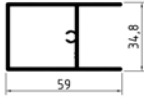
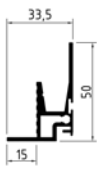
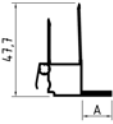

AK-F.2 COVER BOX FOR BOX 240

	Product description	article no.	p.u. m	Unit	price €
	AF-F.2 insulating wedge, revision inside for guide channel 51/240, grey for box 240				
		760401013	1,5	m	
	AF-F.2 insulating wedge, revision inside for guide channel 35/240, grey for box 240				
		760401014	1,5	m	
	AK-F insulation inlay revision inside 240, grey for box 240				
		760406000	1,5	m	
	AF-F.2 insulating wedge, outside revision 240, grey for box 240				
		760402011	1,5	m	
	AK-F insulation wedge venetian blind 240, grey for box 240				
		760403011	1,5	m	

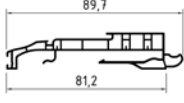
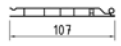

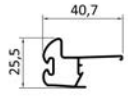
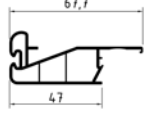

	Product description	article no.	p.u. m	Unit	price €
	AK-F support profile aluminium 15 mm for outside use				
	mill finished	761001400	6	m	
	standard colours	7610014..	6	m	
	RAL	761001499	6	m	
	AK-F support profile aluminium 0 mm for outside use				
	mill finished	761001500	6	m	
	standard colours	7610015..	6	m	
	RAL	761001599	6	m	
	AK-F support profile aluminium clinker brick for outside use				
	mill finished	761001600	6	m	
	AK-F adapter profile aluminium 15/240 for box 240, outside				
		761002100	6	m	
		7610021..	6	m	
		761002199	6	m	
	AK-F support profile PVC, white for inside use				
	15 mm	761001701	6	m	
	45 mm	761001801	6	m	
	110 mm	761001901	6	m	



AK-FLEX.2 BASE PROFILE, REVISION COVER, WIND- ING PROFILE, ADAPTER

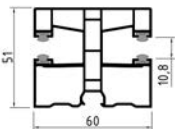
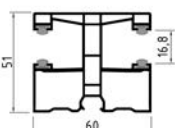

ALUKON

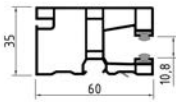
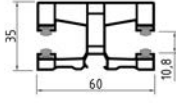
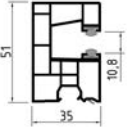

	Product description	article no.	p.u. m	Unit	price €
	AK-F.3 base profile				
	black/white	761021202	6	m	
	AK-F.2 revision cover 107 mm for inside revision (guide channel system 51 mm)				
	white	761022201	6	m	
	white	761022301	6	m	
	AF-F.2 revision cover for inside revision for box 240				
		761022401	6	m	
		761022501	6	m	
	roller rail, interior revision for MIRO+				
	white	711901201	6	m	
	black	711901290	6	m	
	winding profile revision outside for MIRO +				
	white	711901301	6	m	
	black	711901390	6	m	
 	Special reinforcement iron MIRO+				
	Standard (ly = 8,30)	712400200	6	m	
	HST (ly = 2,43)	712400300	6	m	
	Brush for aluminium profile and base profile				
	thin A = 4,25 mm / B = 3,25 mm	119030090	475	m	
	thick brush A = 6,25 mm / B = 5,25 mm	119040090	275	m	
	Brush 10 mm A = 10 mm / B = 9 mm	119100090	400	m	
	Brush 18 mm A = 18 mm / B = 17 mm	119110090	200	m	

adapter profiles and raster for special reinforcement iron see p. 18.5

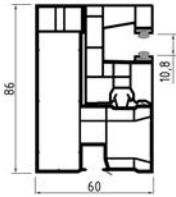
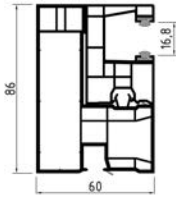
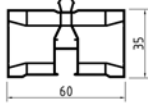
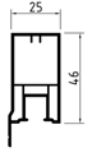
	Product description	article no.	p.u. m	Unit	price €
	K 70 Mini, PVC, with brush				
	white	763017001	6	m	
	DB 703	763017018	6	m	
	22 golden oak 54 charcoal smooth 57 charcoal grained	7630170..	6	m	
	K 70 Maxi, PVC, with brush				
	white	763018001	6	m	
	DB 703	763018018	6	m	
	22 golden oak 54 charcoal smooth 57 charcoal grained	7630180..	6	m	
	DF K 70 Mini, PVC, with brush				
	white	763019001	6	m	
	DB 703	763019018	6	m	
	22 golden oak 54 charcoal smooth 57 charcoal grained	7630190..	6	m	
	DF K 70 Maxi, PVC, with brush				
	white	763020001	6	m	
	DB 703	763020018	6	m	
	22 golden oak 54 charcoal smooth 57 charcoal grained	7630200..	6	m	
	aluminium guide channel with insect protection, without inlay, for top-mounted box, snap-on, for PVC guide channels				
	mill-finished	713080500	30	m	
	white mat 9016	713080526	30	m	
	black 9005 Mat	713080590	30	m	
	RAL	713080599	30	m	
	Extra charge diagonal + thick brush	719912800	30	m	

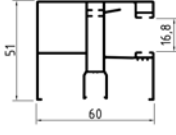
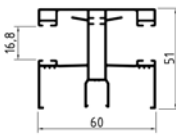
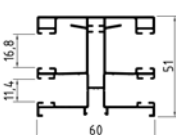
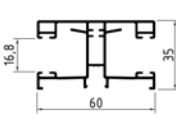
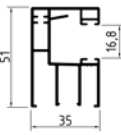

	Product description	article no.	p.u. m	Unit	price €
	K 72, Mini, PVC, with brush (insect protection not possible)				
	white	763021001	6	m	
	DB 703	763021018	6	m	
	22 golden oak 54 charcoal smooth 57 charcoal grained	7630210..	6	m	
	DK 72, Mini, PVC, with brush (insect protection not possible)				
	white	763023001	6	m	
	DB 703	763023018	6	m	
	22 golden oak 54 charcoal smooth 57 charcoal grained	7630230..	6	m	
	K 73, Mini, PVC with brush (insect repellent not possible)				
	white	763028001	6	m	
	DB 703	763028018	6	m	
	22 golden oak 54 charcoal smooth 57 charcoal grained	7630280..	6	m	
	K 73, Maxi, PVC with brush (insect repellent not possible)				
	white	763029001	6	m	
	DB 703	763029018	6	m	
	22 golden oak 54 charcoal smooth 57 charcoal grained	7630290..	6	m	



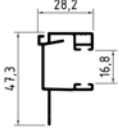
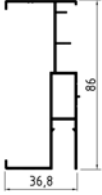
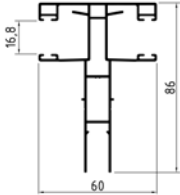
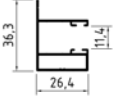

	Product description	article no.	p.u. m	Unit	price €
	K 74 Mini, PVC with brush				
	white	763025001	6	m	
	DB 703	763025018	6	m	
	22 golden oak 54 charcoal smooth 57 charcoal grained	7630250..	6	m	
	K 74 Maxi, PVC with brush				
	white	763026001	6	m	
	DB 703	763026018	6	m	
	22 golden oak 54 charcoal smooth 57 charcoal grained	7630260..	6	m	
	K 70 adapter for outside revision				
	white	763027001	6	m	
	DB 703	763027018	6	m	
	22 golden oak 54 charcoal smooth 57 charcoal grained	7630270..	6	m	
	Guide channel cover PVC 46 mm for venetian blinds clinker brick (not available from stock - please note extended delivery time)				
	white	763026501	6	m	
	DB 703	763026518	6	m	
	22 golden oak 54 charcoal smooth 57 charcoal grained	7630265..	6	m	
	Cover PVC 7 mm for venetian blinds clinker brick (not available from stock - please note extended delivery time)				
	white	763026601	60	m	
	DB 703	763026618	60	m	
	22 golden oak 54 charcoal smooth 57 charcoal grained	7630266..	60	m	

	Product description	article no.	p.u. m	Unit	price €
	A 70 aluminium				
	mill finished	763048000	6	m	
	standard colours	7630480..	6	m	
	RAL	763048099	6	m	
	DF A70 aluminium				
	mill finished	763037000	6	m	
	standard colours	7630370..	6	m	
	RAL	763037099	6	m	
	DF A 71 aluminium with groove for insect repelletion				
	mill finished	763038000	6	m	
	standard colours	7630380..	6	m	
	RAL	763038099	6	m	
	DF A 72 aluminium				
	mill finished	763039000	6	m	
	standard colours	7630390..	6	m	
	RAL	763039099	6	m	
	A 73, aluminium				
	mill finished	763040000	6	m	
	standard colours	7630400..	6	m	
	RAL	763040099	6	m	
	Cover for aluminium guide channel MIRO+ for insect repelling groove				
	mill-finished	713080800	6	m	
	standard colours	7130808..	6	m	
	RAL	713080899	6	m	

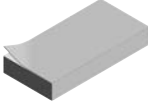
AK-FLEX.2 ALUMINIUM GUIDE CHANNELS AND ADAPTERS

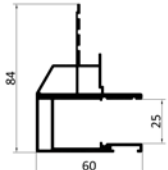
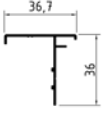
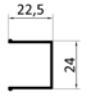
ALUKON

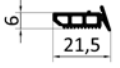
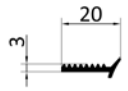



	Product description	article no.	p.u. m	Unit	price €
	A 74, aluminium				
	mill finished	763041000	6	m	
	standard colours	7630410..	6	m	
	RAL	763041099	6	m	
	A 74 adapter, aluminium				
	mill finished	763042000	6	m	
	standard colours	7630420..	6	m	
	RAL	763042099	6	m	
	DF A 74, aluminium#				
	mill finished	763043000	6	m	
	standard colours	7630430..	6	m	
	RAL	763043099	6	m	
	A 24, aluminium insect groove for outside revision/Venetian Blinds				
	mill finished	763044000	6	m	
	standard colours	7630440..	6	m	
	RAL	763044099	6	m	
	Click rail for A 74, self-adhesive				
	plastic, white	763901100	60	m	
	Insulation XPS-SL, 2000x500 mm with single-sided adhesive film				
	Application: isolation of the rear side of the box, TGF	190700200	2	m	

	Product description	article no.	p.u. m	Unit	price €
	A 76-GS aluminium length 520 cm				
	mill finished	763046000	5,2	m	
	standard colours	7630460..	5,2	m	
	RAL	763046099	5,2	m	
	A 76 adapter, aluminium, length 520 cm				
	mill finished	763047000	5,2	m	
	standard colours	7630470..	5,2	m	
	RAL	763047099	5,2	m	
	cover for A 17-GS				
	mill-finished	810003000	6	m	
	standard colours	8100030..	6	m	
	RAL	810003099	6	m	
	edge protection 21 x 10				
	mill-finished	810003200	6	m	
	silver anodized EV 1	810003241	6	m	
	glas seal insert				
	TPE black	810080002	100	m	
	glas seal self-adhesive (double barrelled)				
	EPDM black	810080003	100	m	
	glas support				
	black	810080001	1	pair	

Anti-fall protection for built-on systems see p.5.9

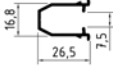
ALK-FLEX .2 INSERT FOR ALUMINIUM GUIDE CHANNELS, VENETIAN BLINDS INSERTS, SURCHARGES

ALUKON

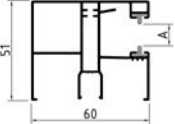
	Product description	article no.	p.u. m	Unit	price €
	K 75 plastic guide channel for venetian blinds, for PVC and aluminium guide channel				
	black	763901000	6	m	
	AK-F insert 3,7 mm for aluminium guide channels with M521/KM521				
	black	763901200	250	m	
	AK-F insert 5,4 mm for aluminium guide channels with MY 442 (base with yellow marking)				
	black	763901300	250	m	
	AK-F insert 6,2 mm for aluminium guide channels with M 3217/KM 317				
	black	763901400	250	m	
	Surcharge for guide channels with built-in insert 2 x insert 3,7 mm A = 14,4 mm 2 x insert 5,4 mm A = 11 mm 2 x insert 6,2 mm A = 9,4 mm				
	Surcharge insert one-sided (GC)	769912900		0	
	Surcharge brush two-sided (GC)	769913200		0	
	Surcharge for guide channel with built-in insect brush (inclined brush and thick brush)				
	Surcharge brush one-sided (GC)	769912800		0	
	Surcharge brush two-sided (GC)	769913100		0	
	Surcharge for guide channels with protection foil for A 70, DF A 71, DF A 72, D 73, DF A 74				
	Surcharge protection foil	769910700		0	

	Product description	article no.	p.u. m	Unit	price €
	AK plug connection for AK-F and MIRO+	713900200	1000	pce	
	Clip for PVC guide channels and revision inside aluminium guide channels	763900301	1000	pce	
	Stopper AK-F.2 Mini rotatable for PVC guide channels Maxi and aluminium guide channels grey/black	209070200	200	pce	
	Stopper AK-F.2 Maxi/aluminium, rotatable for PVC guide channels Maxi and aluminium guide channels grey/black	209070300	200	pce	
	AK-F guide channel closing inlay Mini for roller curtain for PVC guide channels Mini stainless V2A	763901500	20	pce	
	AK-F guide channel closing inlay Maxi/alu for roller curtain for PVC guide channels Maxi and aluminium guide channels stainless V2A	763901600	20	pce	







AK-FLEX-2 HEADERS, GUIDE TERMINALS, ACCESSORIES







ALUKON

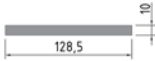

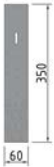

	Product description	article no.	p.u. m	Unit	price €
	AK-F.2 header, black				
	left	767000590	40	pce	
	right	767000690	40	pce	
		767000990	40	pce	
		767001090	40	pce	
	AK-F.2 header isolation, grey				
	revision inside guide channel 51 mm	760601011	500	pce	
	revision inside guide channel 35 mm	760601012	400	pce	
		760601013	200	pce	
		760601014	100	pce	
	AK-F.2 guide terminal revision inside, for guide channel 51 mm				
	white	767008301	25	pair	
	AK-F.2 guide terminal revision inside, for guide channel 35 mm				
	white	767008401	25	pair	
	AK-F.2 guide terminal revision outside				
	white	767008701	25	pair	
	AK-F.2 guide terminal venetian blinds				
	white	767008801	25	pair	
	Guide terminal middle				
	revision inside guide channel 51 mm white	718502100	50	pair	
	revision inside guide channel 35 mm white	767008901	50	pair	
	outside revision, white	718502200	50	pair	
	Support for insect protection				
	revision inside	718501500	25	pair	
	outside revision	767009290	100	pair.	



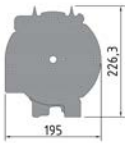
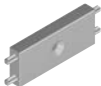

AK-FLEX.2 HEADERS, GUIDE TERMINALS, ACCESSORIES

ALUKON

	Product description	article no.	p.u. m	Unit	price €
	AK-F stopper Mini for roller curtain for PVC guide channels Mini				
	black	767009190	100	pce	
	AK-F stopper Maxi/alu for roller curtain for PVC guide channels Maxi and aluminium guide channels				
	black	767009090	100	pce	
	AK-F flange 107 mm for inside revision with guide channel 51 mm				
	white	767005101	100	pce	
	white	767005201	100	pce	
	AK-F board piece for inside revision for box 240				
		767005301	100	pce	
		767005401	100	pce	
	AK-F.2 pad intended guide channel, inside revision 51 mm, length 100 cm				
	white	767090511	1	m	
	AK-F.2 pad intended guide channel, inside revision 35 mm, length 100 cm				
	white	767090512	1	m	
	AK-F.2 pad intended guide channel, outside revision, length 100 cm				
	white	767090600	1	m	
	AK-F.2 pad intended guide channel, venetian blinds, length 100 cm				
	white	767090700	1	m	

	Product description	article no.	p.u. m	Unit	price €
	AK-F.2 fastening clip left left	767010100	50	pce	
	AK-F.2 fastening clip right right	767010200	50	pce	
	universal clip MIRO + (e.g. for ventian blinds with wood/alu window) Steel, galvanized	718508100	10	pce	
	AK-F mounting bracket for box extension steel, galvanized	767010900	100	pce	
	slot cover for box overhang for MIRO+ size 240 white	718507201	100	pce	
	AK-F.2 fastening angle venetian blind Steel, galvanized	767090101	10	pce	

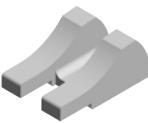



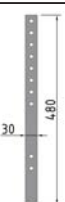
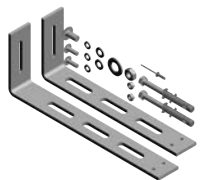

	Product description	article no.	p.u. m	Unit	price €
	AK-F.2 center bearing for linkage and partition white	767080900	1	pce	
	Spacer for MIRO+ displaced coupling black	718102500	100	pce	
	AK-F fitting for double shaft bolts white	767080600	100	pce	
	Double shaft bolt for MIRO+ for shaft 60 mm	718302100	20	pce	
	Pin for BKDF for divided operation or ZipTex Pin for BKDF For clenching at the central end cap. Necessary in case of pin offset or as double guide channel	891200300	1	pce	









	Product description	article no.	p.u. m	Unit	price €
	AK-F.2 static console box height 260 including accessories galvanized steel				
	revision inside with guide channel 51 mm	767061102	1	pce	
	revision inside with guide channel 35 mm	767061502	1	pce	
	outside revision	767061202	1	pce	
	Venetian Blind	767061302	1	pce	
	AK-F.2 static console box height 290 including accessories galvanized steel				
	revision inside with guide channel 51 mm	767062102	1	pce	
	revision inside with guide channel 35 mm	767062502	1	pce	
	outside revision	767062202	1	pce	
	Venetian Blind	767062302	1	pce	
	AK-F.3 static bracket box height 240 incl accessories steel, zinc-plated for box 240				
		767063100	1	pce	
		767063500	1	pce	
		767063200	1	pce	
		767063300	1	pce	
	AK-F.2 isolation wedge for static console, inside revision				
	for 270 mm and clinker box	767900601	200	pce	
	for 240 mm box	767900604	50	pce	
	AK-F.2 static console cover below for outside revision				
		767900603	100	pce	
	AK-F.2 static console cover inside for box depth >270, for all AK-F.3 static consoles				
		767900602	100	pce	

	Product description	article no.	p.u. m	Unit	price €
	AK-F.2 additional box fastening, plastic black	767060501	250	pce	
	AK-F clamping band aluminium, natural	767060600	50	pce	
	AK-F angle consoles set, including fixation material galvanized	767060400	1	pce	



AK-FLEX.2 PULLEYS, ROLLER CAPS, SUPPORT PLATES

ALUKON



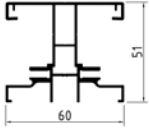
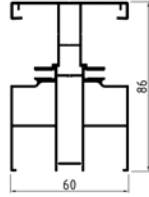
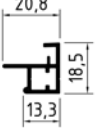

	Product description	article no.	p.u. m	Unit	price €
	AK-F pulley for 14 mm tape 170 mm	767020100	100	pce	
	AK-F roller cap 117 mm without ball bearing for 14 mm tape for shaft 60 mm	249412400	1	pce	
	AK-F pulley for 22 mm tape Pulley new building 170 mm for 60 mm shaft	267011700	1	pce	
	Roller cap 150 mm for AK-F and AK-R without ball bearing with bearing intake 28 mm without ball bearing	249410400	1	pce	
	Pulleys for belt transmission 2:1 for belt 14 mm Pulley 165 mm	240110400	1	pce	
	Roller cap for AK-F and AK-R for tape gear 2:1 for shaft 60 mm	240111000	100	pce	

	Product description	article no.	p.u. m	Unit	price €
	AK-F belt guide downwards for belt 14 mm				
	white	767030100	100	pce	
	AK-F belt guide to the rear for belt 22 mm				
	white	767031100	100	pce	
	Swivel support 45°, removable with universal joint, with 6 mm square bar, 22 x 52 mm operation downward				
		240303500	1	pce	
	AK-F base plate, belt/crank guide for outside revision, operation downward				
	white	767030001	10	pce	
	AK-F base plate, crank guide for rear side, only for NHK operation				
	white	767030201	10	pce	
	Bearing plate for MIRO+				
	black	718501100	100	pce	
	Bolt for bearing plate V2 for MIRO+				
	Red (price per 100 pieces)	718501210	100	pce	
	Distance ring for bearing plate for MIRO+				
	Red (price per 100 pieces)	718501300	100	pce	

Belt and bevel gears can be found in chapter 12 of this catalogue.



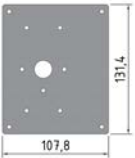

	Product description	article no.	p.u. m	Unit	price €
	DF A 36, aluminium				
	mill finished	763054000	6	m	
	standard colours	7630540..	6	m	
	RAL	763054099	6	m	
	DF A 37, aluminium				
	mill finished	763055000	6	m	
	standard colours	7630550..	6	m	
	RAL	763055099	6	m	
	AK-F ZipTex A 34				
	mill-finished	763052000	6	m	
	standard colours	7630520..	6	m	
	RAL	763052099	6	m	
	AK-F FS-Inlay for A 31/A 33 (closed)				
	stainless V2A	748040200	20	pce	

The plastic guidance ZipTexcan be found on page 16.11.

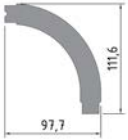
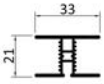

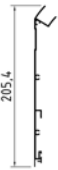

	Product description	article no.	p.u. m	Unit	price €
	AK-F.2 ZipTex deflector plate galvanized	767040401	10	pce	
	AK-F.2 ZipTex distance clamp für deflector plate galvanized	767040501	10	pce	
	AK-F. ZipTex support plate 108x131 mm galvanized	767040601	10	pce	
	Universal drive support including spring washer with small loop for Somfy-HiPro	241030200	1	pce	

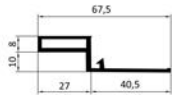
see also chapter 16 ZipTex

	Product description	article no.	p.u. m	Unit	price €
	AK-R upper part, grey Length 150 cm	760102000	1,5	m	
	AK-R inner part, grey Length 150 cm	760301000	1,5	m	
	AK-R.2 isolation wedge, grey length 150 cm	760405001	1,5	m	
	AK-R connection profile white	761030001	60	m	

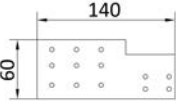
	Product description	article no.	p.u. m	Unit	price €
	AK-R.2. outside cover				
	mill finished	761032100	6	m	
	standard colours	7610321..	6	m	
	RAL	761032199	6	m	
	AK-R access flap, white				
	180 mm	761030501	6	m	
	260 mm	761030601	6	m	
	AK-R.2 support for revision cover				
	white	761030701	6	m	
	AK-R compensation profile 15 x 10 Connection of the access flap for Beck & Heun boxes				
	white	761033101	6	m	
	AK-R compensation profile Connection of the access flap for Beck & Heun Roka				
	white	761033201	6	m	

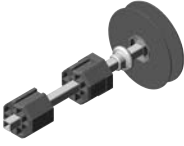
	Product description	article no.	p.u. m	Unit	price €
	AK-R.2 header, white				
	left	768000301	25	pce	
	right	768000401	25	pce	
		768000501	25	pce	
		768000601	25	pce	
	AK-R.2 center bearing for linkage and partition				
	white	767081000	1	pce	
	AK-R plaster baize 25x260				
	left	767070101	10	pce	
	right	767070201	10	pce	
	AK-R plaster baize 40x260				
	left	767070301	10	pce	
	right	767070401	10	pce	
	AK-F Pin				
	white	767007100	100	pce	
	Pulley GSV 155				
	ABS	261550100	50	pce	
	Pulley for transmission 2:1, for belt 14 mm				
	Pulley 150 mmpulley 150 mm	240110300	1	pce	
	Bearing plate for AK-F and AK-R 100 x 100 mm				
	steel, galvanized	767040100	10	pce	

	Product description	article no.	p.u. m	Unit	price €
	AK-R.2 static console incl. accessories Steel, galvanized	767061601	1	pce	
	AK-R mounting lug galvanized	767010500	10	pce	
		767040201	10	pce	
	for tape 22 mm	767040300	20	pce	
	AK-F.2 head plug L = 35 mm white	767900101	50	pce	

1 **BLENDEN**

BLENDKAPPEN, ANROLLKONSOLEN UND EINLAUFROLLEN

Coffres, flasques, consoles à chariots enrouleurs, rouleaux de guidage

Boxes, end caps, automatic start mechanism, guide rolls

Schránky, bočnice, navíjecí konzoly, naváděcí rolny

Skrzynki, boczki skrzynek, konsole jezdne (rolkowe), rolki naprowadzające

Aluminium kasten, kapsteunen, rolconsoles en inlooprollen

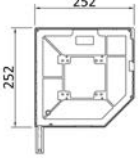
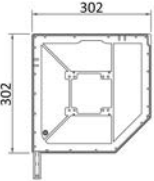
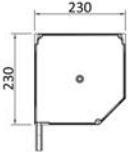

Tokok, tokvégek, görgős konzolok, bevezető görgők

	Product description	article no.	p.u. m	Unit	price €
	BKT 254				
	Pressure moulded end cap, bevelled 45° powder coated or mill-finished for roller doors up to max. surface of 10 m ² , with drill hole for screw-on support				
	mill-finished	352541000	6	pair	
	standard colours	3525410..	6	pair	
	21 brown SF	26 white 9016 mat			
	RAL	352541099	6	pair	
	BKT 300				
	Pressure moulded end cap, bevelled 45° powder coated or mill-finished for roller doors up to max. surface of 10 m ² , with drill hole for screw-on support				
	mill-finished	353001000	6	pair	
	standard colours	3530010..	6	pair	
	21 brown SF	26 white 9016 mat			
	RAL	353001099	6	pair	
	BKS 230				
	Pressure moulded end caps, bevelled 45° powder coated or mill-finished for smaller roller doors Foot suits GTF 75 only				
	mill-finished	082300000	6	pair	
	standard colours	0823000..	6	pair	
	21 brown SF	26 white 9016 mat			
	RAL	082300099	6	pair	

STEEL END CAPS WITH AUTOMATIC START MECHANISM FOR ROLLER DOORS

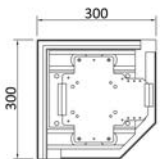
ALUKON

	Product description	article no.	p.u. m	Unit	price €
	SBK 300				
	Steel end caps, bevelled 45° powder coated or under coated with fit-in square profil including extruded automatic start mechanism				
	primed	353002042	1	pair	
	standard colours	3530020..	1	pair	
	21 brown SF	26 white 9016 mat			
	RAL	353002099	1	pair	
	SBK 360				
	primed	353602042	1	pair	
	standard colours	3536020..	1	pair	
	21 brown SF	26 white 9016 mat			
RAL	353602099	1	pair		

	Product description	article no.	p.u. m	Unit	price €
	Steel roll-on consoles galvanized Dimensions: 320 x 198 / 298 mm for large and heavy roller doors without boxes with cutout for welding shaft and drill holes to fasten all bearing plates				
	Roll-on console AK-A	358010200	1	pair	
	Polyamide guide rolls For guide channel RTF 65	359020200	1	pair	
	Polyamide guide rolls for BKT / BKS	359020100	1	pair	
	Guide roll set for steel and caps SBK / SBKVR	359020600	1	pce	

2 FÜHRUNGSSCHIENEN UND BEFESTIGUNGSWINKEL

Coulisses et angles de fixation

Guide channels and mounting angles

Vodící lišty a upevňovací úhelník

Prowadnice i kątowniki mocujące

Geleiders en bevestigingshoeken

Vezető sínek és rögzítő „L” profilok

EXTRUDED GUIDE CHANNELS

FOR ROLLER DOORS WITH BOX

ALUKON

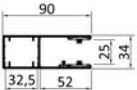
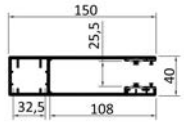
	Product description	article no.	p.u. m	Unit	price €
	RTF 90				
	Aluminium guide channel, extruded, powder coated for roller door profile T 77 and roller grill with special PVC brush insert and filling brush in 6,0 m length				
	mill-finished (without insert), 4,80 m	340904800	24	m	
	mill-finished (without insert), 6,00 m	340906000	30	m	
	standard colours , 4,80 m	3409048..	24	m	
	standard colours , 6,00 m	3409060..	30	m	
	21 brown SF	26 white 9016 mat			
	RAL , 4,80 m	340904899	24	m	
RAL , 6,00 m	340906099	30	m		
	RTF 150.2				
	Aluminium guide channel, extruded, powder coated for roller door profile T 77 and roller grill with special PVC brush insert and filling brush in 6,0 m length				
	mill-finished (without insert), 6,00 m	341516000	6	m	
	standard colours , 6,00 m	3415160..	6	m	
	21 brown SF	26 white 9016 mat			
RAL , 6,00 m	341516099	6	m		

EXTRUDED GUIDE CHANNELS

FOR ROLLER DOORS WITH BOX

ALUKON

	Product description	article no.	p.u. m	Unit	price €	
	RTF 100					
	Aluminium guide channel, extruded, powder coated for roller door profile T 77, with storm hook with special PVC brush insert and filling brush in 6,0 m					
	mill-finished (without insert), 6,00 m	341006000	18	m		
	standard colours , 6,00 m	3410060..	18	m		
	21 brown SF	26 white 9016 mat				
	RAL , 6,00 m	341006099	18	m		

EXTRUDED GUIDE CHANNELS

FOR ROLLER DOORS

ALUKON

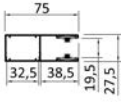
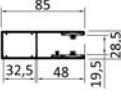
	Product description	article no.	p.u. m	Unit	price €
	Aluminium guide channel, extruded, powder coated for profile M 551 and E 55 for garage doors with box, with a special PVC-brush insert The guide channel GTF 850 is provided with an extra filling brush. in 4,80 m and 6,00 m length (cf. 6th or 7th position of article number)				
	GTF 750				
	mill-finished (without insert), 4,80 m	340754800	24	m	
	mill-finished (without insert), 6,00 m	340756000	30	m	
	standard colours , 4,80 m	3407548..	24	m	
	standard colours , 6,00 m	3407560..	30	m	
	21 brown SF	26 white 9016 mat			
	RAL , 4,80 m	340754899	24	m	
	RAL , 6,00 m	340756099	30	m	
		GTF 850			
mill-finished (without insert), 4,80 m		340854800	24	m	
mill-finished (without insert), 6,00 m		340856000	30	m	
standard colours , 4,80 m		3408548..	24	m	
standard colours , 6,00 m		3408560..	30	m	
21 brown SF		26 white 9016 mat			
RAL , 4,80 m		340854899	24	m	
RAL , 6,00 m		340856099	30	m	

EXTRUDED GUIDE CHANNELS

FOR ROLLER DOORS



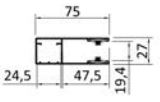

ALUKON

	Product description	article no.	p.u. m	Unit	price €	
	GTF 75					
	Aluminium guide channel, extruded, powder coated for profile M 551 and E 55 for roller doors with box, with hard-PVC insert Attention: The guide channel GTF 75 can only be used with the end cap BKS 230, due to its special chamber size. in 4,80 m and 6,00 m length (cf. 6th or 7th position of article number)					
	mill-finished (without insert), 4,80 m	130754800	24	m		
	mill-finished (without insert), 6,00 m	130750000	30	m		
	standard colours , 4,80 m	1307548..	24	m		
	standard colours , 6,00 m	1307500..	30	m		
	21 brown SF	26 white 9016 mat				
	RAL , 4,80 m	130754899	24	m		
	RAL , 6,00 m	130750099	30	m		

PVC- AND BRUSH INSERTS FOR ROLLER DOOR PRO-FILES

ALUKON

AND SOUND ABSORPTION

	Product description	article no.	p.u. m	Unit	price €
	Solid PVC insert				
	with integrated brush for RTF / GTF	349010300	140	m	
	Filling brush				
	for RTF 65 and 90	349020100	200	m	
	brush for RTF 100 and 150.2				
	thick brush A = 6,25 mm / B = 5,25 mm	119040090	275	m	
	Filling brush				
	for blackout effect, brush height 8mm	119090090	250	m	
	Brushes and inserts in small quantities				
	double-sided protection film	349910800		m	
	Extra charge for brushes and inserts in small quantities (per piece)	890000200		pce	

3 TORPROFILE

SICHTFENSTER, LÜFTUNGSGITTER UND ARRETIERCLIPSE

Lames portes enroulables, lame hublot, lame d'aération, embouts de lame

Roller door profiles, vision windows, ventilation grill, locking clips

Vratové lamely, prosvět. okénka a pásky, provzdušňovací mřížky, aretační klipsy

Profile bramowe, z wzornikami (okienkami), z kratką wentylacyjną, aretki

Deurprofielen, zichtvensters, beluchtingsvensters en arreterclips

Kapulécek, ablakos lécek, szellőztető lécek, arriterek

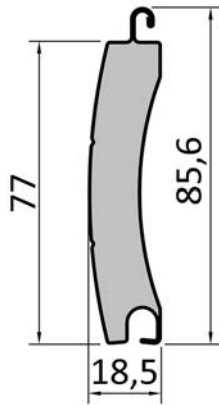

Technical data

Profile height	mm	85,60
Profile thickness	mm	18,50
Profile cover height	mm	77,00
Material thickness	mm	0,49
Weight	kg/m ²	5,00
Max width	cm	540,00
Max area	m ²	16,00
Length	cm	535,00
Length	cm	680,00
Packing unit	Slats	10,00

Bale diameter

height of curtain in cm	with 70 mm octagonal shaft and slide over ring (80 mm) in cm	with 125 mm steel winding shaft in cm
200	24,40	26,50
225	27,60	27,00
250	28,00	27,40
275	28,20	29,20
300	29,60	30,00
325	29,60	30,40
350	30,20	32,40
375	32,00	33,00
400	32,80	33,00

List of articles including prices in €/m

Part number length 5,35 m	Part number length 6,80 m	Colour description	Price
321755301	321756801	white	
321755302	321756802	grey	
321755303	321756803	velvet brown	
321755304	321756804	light beige	
321755307	321756807	natural	
321755313	321756813	moss green	
321755314	321756814	purple red	
321755327	321756827	cream white	
321755330	321756830	jamaican brown	
321755384	321756884	light ivory	
321755385	321756885	grey aluminium 9007	
321755312	321756812	teak	
321755322	321756822	golden oak	
321755338	321756838	charcoal	

colour number	Colour description	price
28	fir green 6009*	auf Anfrag e
39	light blue 5011*	auf Anfrag e
90	black*	auf Anfrag e

*These colours are only produced to order with a longer delivery time

SURCHARGES FOR VISION WINDOW PROFILES AND VENTILATION GRILLS

ALUKON

IN ROLL FORMED T 77-PROFILES

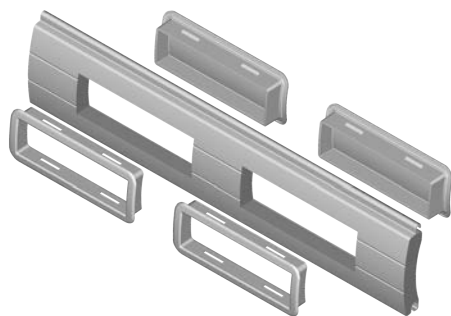

Technical data

Weight (T 77 + ...)	g/pce	12,86
Max. Length	cm	605,00
Packing unit	Slats	1,00
	cm	

Extra charges for vision window profile SFP-R

	3980014..	---
Cutout including vision windows / ventilation grill	3399925..	

SURCHARGES FOR VISION WINDOW PROFILES AND VENTILATION GRILLS

ALUKON

IN ROLL FORMED T 77-PROFILES

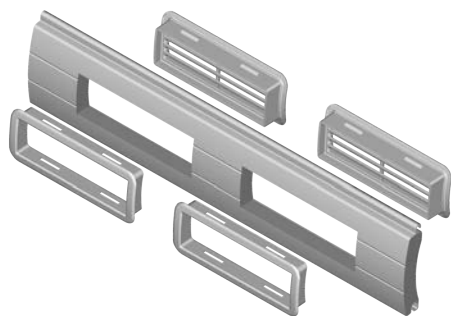

Technical data

Weight (T 77 + ...)	g/pce	4,00
Max. Length	cm	605,00
Packing unit	Slats	1,00
	cm	

Extra charges for ventilation profile LP-R 77

	3980014..	---
Cutout including vision windows / ventilation grill	3399925..	

EXTRUDED ALUMINIUM ROLLER DOOR PROFILE

SL 77, WITHOUT FOAM

(WITH STRUCTURED COATING)

ALUKON

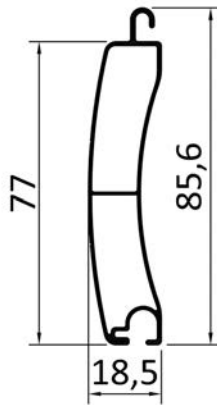

Technical data

Profile height	mm	85,60
Profile thickness	mm	18,50
Profile cover height	mm	77,00
Material thickness	mm	1,00
Weight	kg/m ²	8,50
Max width*	cm	650,00
Max area*	m ²	20,00
Length	cm	535,00
Length	cm	680,00
Packing unit	Slats	5,00

Bale diameter

height of curtain in cm	with 70 mm octagonal shaft and slide over ring (80 mm) in cm	with 125 mm steel winding shaft in cm
200	25,00	27,00
225	26,70	27,40
250	27,20	27,40
275	27,20	30,00
300	29,80	30,20
325	30,20	30,80
350	30,50	31,60
375	31,40	33,20
400	33,50	33,80
425	33,50	34,00
450	36,80	36,60

List of articles including prices in €/m

Part number length 5,35 m	Part number length 6,80 m	Colour description	Price
370805300	370806800	mill-finished, 5,35 m	
370805399	370806899	RAL, 5,35 m	

For an overview of all 30 structured colours, please refer to section "technical overview" at the end of this catalogue.

Other RAL structure colours are only available with larger order quantity and on request.

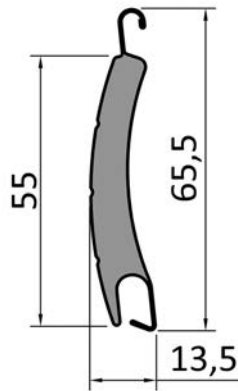

Technical data

Profile height	mm	65,50
Profile thickness	mm	13,50
Profile cover height	mm	55,00
Material thickness	mm	0,43
Weight	kg/m ²	5,00
Max width*	cm	350,00
Max area*	m ²	8,00
Length	cm	600,00
Packing unit	m	144,00

Bale diameter

height of curtain in cm	with 60/70 mm octagonal shaft and slide over ring 80 in cm
100	17,50
120	17,50
140	20,00
160	20,00
180	20,00
200	22,00
225	22,00
250	24,50
275	24,50
300	24,50
325	24,50
350	24,50
375	26,00
400	26,00

List of articles including prices in €/m

Part number without light slits	Part number with light slits	Colour description	Price
275510101	275510201	white	
275510102	275510202	grey	
275510103	275510203	velvet brown	
275510104	275510204	light beige	
275510107	275510207	natural	
275510112	275510212	teak	
275510122	275510222	golden oak	
275510127	275510227	cream white	
275510130	275510230	jamaican brown	
275510138	275510238	charcoal	
275510190	275510290	black	

EXTRUDED DOUBLE WALL ALUMINIUM ROLLER SHUTTER PROFILE E 55 (MAXI) (WITH STRUCTURED COATING)

ALUKON

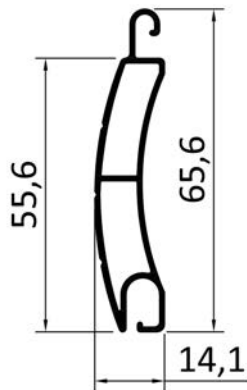

Technical data

Profile height	mm	65,60
Profile thickness	mm	14,10
Profile cover height	mm	55,60
Material thickness	mm	1,00
Weight	kg/m ²	8,50
Max width*	cm	320,00
Max area*	m ²	7,00
Length	cm	580,00
Packing unit	m	58,00

Bale diameter

height of curtain in cm	mit 70 mm 8-Kantwelle u. Aufsteckring 80 in cm
200	20,60
225	22,00
250	22,80
275	22,80
300	25,00
325	25,00
350	26,20
375	27,40
400	27,40

List of articles including prices in €/m

Part number without light slits	Colour description	Price
802550100	mill-finished	
802550199	30 ALUKON structure colours	

Part number with light slits	Colour description	Price
802550200	mill-finished	
802550299	30 ALUKON structure colours	

For an overview of all 30 structured colours, please refer to section "technical overview" at the end of this catalogue.

Other RAL structure colours are only available with larger order quantity and on request.

EXTRUDED VISION WINDOW PROFILE SFP-S FOR ROLLER DOORS,

ALUKON

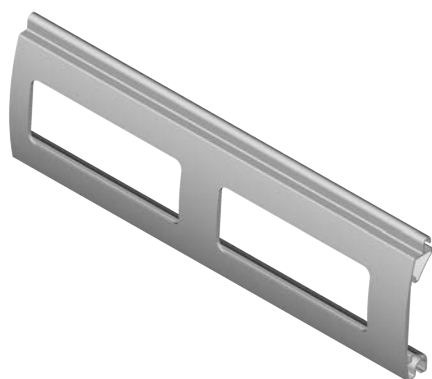

Technical data

Profile height	mm	85,60
Profile thickness	mm	18,50
Profile cover height	mm	77,00
Material thickness	mm	1,20
Weight without insert	kg/m ²	7,50
Weight with Polycarbonat	kg/m ²	9,00
Max width	cm	650,00
Max height	cm	300,00
Max area without insert	m ²	20,00
Max area with Polycarbonat	m ²	18,00
Length	cm	535,00
Length	cm	680,00
Packing unit	Slats	5,00

Bale diameter

height of curtain in cm	with 70 mm octagonal shaft and slide over ring (80 mm) in cm	with 125 mm steel winding shaft in cm
200	21,40	23,40
225	22,20	25,20
250	23,20	25,80
275	25,00	25,80
300	25,20	28,40





List of articles including prices in €/m

Part number length 5,35 m	Part number length 6,80 m	Colour description	Price
323015300	323016800	mill-finished	
323015399	323016899	30 ALUKON structure colours	

For an overview of all 30 structured colours, please refer to "technical overview".

ACCESSORIES FOR VISION WINDOW PROFILES, VENTILATION PROFILES

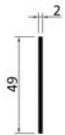
ALUKON

	Product description	article no.	p.u. m	Unit	price €
	Vision window for SFP-R 77 (for the cutout frame and vision window are needed)				
	Frame black	329120100	400	pce	
	Vision window for RR, transparent	329120200	400	pce	
	Vision window for LR, transparent	329120300	400	pce	
	Ventilation grill for LP-R 77 (for the cutout, frame and ventilation grill are needed)				
	Frame black	329120100	400	pce	
	Ventilation grill 130 mm, black	329120400	400	pce	
	Strip for SFP-S made of polycarbonate UV-resistant (thickness: 2 mm)				
		329110100	1	pce	
	Leveling piece for SFP-S made of polyamide for optimal rolling characteristics of roller grill SFP-S (without polycarbonate insert), put the leveling pieces in the upper 4 profiles at a distance of one meter each				
		329110300	100	pce	

LOCKING CLIPS FOR ROLLER DOOR PROFILES AND EXTRUDED PROFILES

ALUKON

	Product description	article no.	p.u. m	Unit	price €
	Locking clips for M 551 + M 528 for both sides				
	for both sides (price per 100 pieces)	279550400	250	pce	
	Locking clips for T 77 and SFP-R for both sides				
		329770100	250	pce	
	Locking clips 2.0 for T 77 and SFP-R for both sides				
		329771400	250	pce	
	Screws 4,5 x 70 mm countersunk galvanized countersunk galvanized , 4,5 x 70 mm (price per 100 pieces)				
		891191200	200	pce	
	Drilling template for locking clips T 77 2.0				
		329110400	1	pce	
	Locking clips for SL 77 left + right				
		329771200	50	pair	
	Locking clips for SFP-S left + right				
		329771100	50	pair	
	Locking clips for E55 (to rivet) left + right (Price per 100 pair)				
		809550300	100	pair	

4 TORFERTIGPANZER

Tabliers finis pour portes enroulables

Curtains for roller doors

Hotové pancíře

Gotowe pancerze wykonane z profili bramowych

Complete roldeurpantser

Készre gyártott kapupalástok

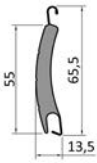
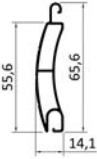
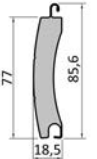
	Product description	article no.	p.u. m	Unit	Price / m ²
	Curtain M 551 (for technical details please refer to section 7)				
	standard colours locked 01 white 02 grey 03 velvet brown 04 beige 07 natural 12 teak 22 golden oak 27 cream white 30 jamaican brown 38 charcoal 90 black	4055101..	1	pce	
	Curtain E 55 (for technical details please refer to section 7)				
	30 ALUKON structure colours locked 30 ALUKON structure colours unlocked	822550199 822550099	1 1	pce pce	
	Roller door curtain T 77 - foamed aluminium - min height 140 cm; max height slider 485 cm; max surface slider 16 m2 max height storm anchor 456 cm; max surface storm anchor 20 m2				
	standard colours locked 01 white 02 grey 03 velvet brown 04 beige 07 natural 12 teak 13 moss green 14 purple red 22 golden oak 27 cream white 30 jamaican brown 38 charcoal 84 light ivory 85 Aluminium grey 9007	331770100	1	pce	

All curtains including spring bolt, standard end slat.

Attention : Minimum area for price calculation is 1 m².

	Product description	article no.	p.u. m	Unit	price €
	Extra charge polycarbonat strips	339990100		m ²	
	Surcharge for extruded ventilation profile	339991300		m	
	Extra charge DLT locking	339991500		m	
	Cutout including vision windows / ventilation grill	339992500		pce	
	Extra charge for safety switch-off device OSE	339994500		m	
	Surcharge connecting accessories OSE	379980400		pce	
	Extra charge anti-lift device	339992900		m	

5 SCHLUSSLEISTEN UND UNTERSCHIENENABSCHALTUNG

Lames finales et barre palpeuse

Final slats and safety switch-off device

Ukončovací lišty a vypínání ukončovací lišty

Listwy końcowe i wyłączniki podlistwowe

Onderlatten en onderlatbeveiligingen



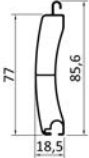

Zárólécek és biztonsági alsósíncapcsoló

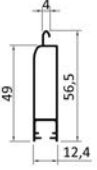
	Product description	article no.	p.u. m	Unit	price €
	Extruded aluminium end slat for roller door profile T 77 and P 77, blind surface 77 mm, powder coated with structured coating, with groove for PVC profile GAP and safety switch-off device Can also be used as extruded curtain in 5,35 m or 6,80 m length (cf. 6th + 7th position of article number)				
	SL RT				
	mill-finished , 5,35 m	370805300	26,75	m	
	mill-finished , 6,80 m	370806800	34	m	
	standard colours 5,35 m	3708053..	26,75	m	
	standard colours 6,8 m	3708068..	34	m	
	08 silver	31 white			
	14 purple red	33 velvet brown			
	29 moss green				
	30 jamaica brown				
	silver anodized EV 1, 5,35 m	370805341	26,75	m	
	silver anodized EV 1, 6,80 m	370806841	34	m	
	bronze anodized BC 4, 5,35 m	3708053..	26,75	m	
	bronze anodized BC 4, 6,80 m	3708068..	34	m	
	RAL , 5,35 m	370805399	26,75	m	
RAL (str. coating), 6,80 m	370806899	34	m		

Please note: There is no stock service in bronze anodized BC 4 and C 33. A certain delivery time should be accepted.

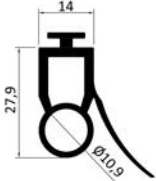

	Product description	article no.	p.u. m	Unit	price €	
	Extruded aluminium end slat for roller door profile M 551, blind surface 50 mm, powder coated , with groove for PVC end profile SL NG and safety switch-off device					
	SL NG					
	mill-finished	201500000	60	m		
	standard colours	2015000..	60	m		
	03 nougat brown 21 brown SF 87	26 white 9016 mat telegrey 7047 mat				
	silver anodized EV 1	201500041	60	m		
	bronze anodized BC 4	2015000..	60	m		
	RAL	201500099	60	m		

Please note: There is no stock service in bronze anodized BC 4 and C 33. A certain delivery time should be accepted.

	Product description	article no.	p.u. m	Unit	price €
	GAP (rubber profile)				
	black	379010200	50	m	
	Rubber profile for OSE 1.0				
	OSE with insert	379040500	50	m	
	Extra charge for inserts in small quantities (per piece)				
	Extra charge for brushes and inserts in small quantities (per piece)	890000200		pce	
	Transmitter IR for OSE 1.0				
		379040200	1	pce	
	Receiver IR for OSE 1.0				
		379040300	1	pce	
	PVC end profile for SL-NG				
	for SL NG, SL 521-DB and WSL	209130000	6	m	



STOPPER FOR ROLLER DOORS

ALUKON

	Product description	article no.	p.u. m	Unit	price €
	Roller door stopper for SL RT	379040400	10	pce	
	Roller door stopper for SL NG	379040700	10	pce	

END SLATS WITH ASSEMBLED SAFETY SWITCH-OFF DEVICE

ALUKON

	Product description	article no.	p.u. m	Unit	price €
	SL RT with assembled OSE 1.0 (price for SL RT see page 5T.1)				
	OSE with insert	379040500	50	m	
	Surcharge connecting accessories OSE	379980400		pce	
	Handling surcharge - OSE connection on end slat	379980200		pce	
	SL NG with assembled OSE 1.0 (price for SL NG see page 5T.2)				
	OSE with insert	379040500	50	m	
	Surcharge connecting accessories OSE	379980400		pce	
	Handling surcharge - OSE connection on end slat	379980200		pce	

6 STAHLWELLEN

AUFHÄNGUNGEN, WELLENBOLZEN, EINSCHWEIßWELLEN, FLANSCHLAGER UND ZUBEHÖR

Tubes en acier, suspensions, boulons d'axe, arbres de soudage,
 flasques de support



Steel shafts, suspensions, shaft bolts, welding shafts, flange support
 and
 accessories

Ocelové hřídele, závěsy, hřídelové čepy, vnitřní hřídele, přírubové
 ložisko

Wałki stalowe, szyny zawieszenia, wieszaki, sworznie, wałki spawane,
 łożyska flanszowe

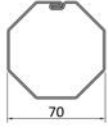

Stalen assen, ophangingen, asproppen, tegenlagers en flenskogellager

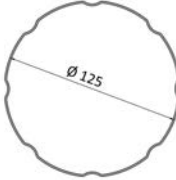
Acél tengelyek, függesztékek, tengelycsapok, hegesztett tengelyek,
 csapágyak és tartozékok



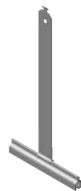

	Product description	article no.	p.u. m	Unit	price €
	Steel octagonal shaft Ø 70 mm				
	Ø 70 mm, 1,5 mm, 5,35 m	360705300	5,35	m	
	Ø 70 mm, 1,5 mm, 6,80m	360706800	6,80	m	
	PVC sleeve				
	83 mm diameter for octagonal steel shaft (70 x 1,5 mm; needed when using profiles M 551 and T 77)	362010100	1	pce	
	steel winding shaft Ø 125 mm				
	Ø 125 mm, 1,5 mm, 5,00 m	361255000	5	m	
	Ø 125 mm, 1,5 mm, 6,80 m	361256800	6,80	m	

SUSPENSION RAIL AND STEEL STRAP SUSPENSION FOR ROLLER DOORS

ALUKON

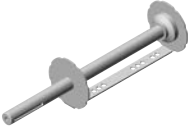
	Product description	article no.	p.u. m	Unit	price €
	Aluminium suspension rail extruded, mill-finished only for steel shafts Ø 125 mm				
	suspension rail 600 mm	362020100	30	m	
	Steel strap suspension surface powder coated , to hinge				
	new building no. 3, length 190 mm	211100700	250	pce	
	Steel strap suspension with cover 80 x 305mm, 1,5mm thick. Please note: use for extruded profiles and roller door profiles T77 mandatory.				
	white	211320100	150	pce	



	Product description	article no.	p.u. m	Unit	price €
	Shaft bolt for octagonal shaft 70 mm, with PVC roller cap and ball bearing	362110200	1	pce	
	Shaft bolt for octagonal shaft 70 mm, with PVC roller cap and square pin 18 x 18 mm	362110100	1	pce	
	Shaft bolt for steel shaft 125 mm with square pin for safety brake with 2 PVC roller end caps, 1 adapter and driver made of fibre glass reinforced polyamide	362120100	1	pce	
	Shaft bolt for steel shaft 125 mm with ball bearing with 2 PVC roller end caps, 1 adapter and driver made of fibre glass reinforced polyamide	362120200	1	pce	
	Adapter for steel shaft 125 mm with edge	381050100	1	pce	
	Adapter and driver for shaft 125 mm for Somfy motor E - 130 x 2,0 aluminium driver	381050300	1	pce	

	Product description	article no.	p.u. m	Unit	price €
	<p>Welding shaft type EW-A / FL</p> <p>Length 495 mm</p> <ul style="list-style-type: none"> - for clip-on drive or - for safety brake > 170 kg - for flange bearing (opposite side of the clip-on drive) <p>for steel shaft 125 mm</p>	362210100	1	pce	
	<p>Welding shaft type EW-ARS</p> <p>Length 250 mm</p> <ul style="list-style-type: none"> - for safety brake up to 170 kg <p>for steel shaft 125 mm</p>	362210200	1	pce	
	<p>Set collar</p> <p>with screw</p> <p>to adjust the welding shaft</p>	362240200	1	pce	
	<p>Flange support FL</p> <p>to fix the welding shaft on the roll-on console</p> <p>AK-A</p>	362250100	1	pce	

ACCESSORIES FOR ROLLER GRILLES AND ROLLER DOORS

ALUKON

- ANTI-LIFT DEVICE -

	Product description	article no.	p.u. m	Unit	price €
	Security bolt with protection support				
	3-part	379090200	1	pce	
	4-part	379090300	1	pce	
	Mounting ring for security bolts				
	for steel shaft 60 mm	379091600	1	pair	
	for steel shaft 70 mm	379090400	1	pair	

7 ROHRMOTOREN

ABROLLSICHERUNGEN UND ZUBEHÖR

Moteurs tubulaires, anti-chutes et accessoires

Tubular drives, electric drives, safety brakes and accessories

Motory, pojistky proti odvinutí a příslušenství





Silniki rurowe, hamulce inercyjne oraz osprzęt dodatkowy

Buismotoren, opsteekaandrijvingen, afrolbeveiligingen en toebehoren

Csőmotorok, zuhanás gátlók és tartozékok

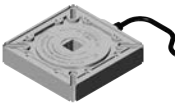
SAFETY BRAKE AND BEARING PLATES FOR ROLLER DOORS







ALUKON



	Product description	article no.	p.u. m	Unit	price €
	Safety brake for roller doors up to 170 kg with electronic switch-off with 8 m cable	391040500	1	pce	
	Safety brake for roller doors from 170 kg, with 0,75 m cable with electronic switch-off	391040400	1	pce	
	Bearing plate for Somfy motor without emergency crank handle 100 x 100 mm	391030400	1	pce	
	Bearing plate for Somfy motor with emergency crank handle 100 x 100 mm	391030600	1	pce	





Somfy tubular drives with adapter and driver for
70 mm octagonal steel shaft without switch, with 3 m cable.
Alternatively with emergency crank handle ("NHK")



List of articles including prices in €/m

description	traction in kg up to height							R/min	Part no.	price / piece
	2,00 m	2,50 m	3,00 m	3,50 m	4,00 m	4,50 m	5,00 m			
M 551 with 70 mm octagonal steel shaft with slide over ring Ø 83 mm										
Meteor 20/17	34	32	30	27	25	24	23	17	380412100	
Meteor 20/17 mit NHK	34	32	30	27	25	24	23	17	240403300	
Gemini 25/17	43	40	38	34	32	30	29	17	380412200	
Gemini 25/17 mit NHK	43	40	38	34	32	30	29	17	240403400	
Apollo 30/17	52	48	45	41	38	36	35	17	380412300	
Mariner 40/17	69	63	60	54	51	48	46	17	380412400	
Mariner 40/17 mit NHK	69	63	60	54	51	48	46	17	380410100	
Vega 60/12	103	95	90	82	76	72	69	12	380411200	
Vega 60/12 mit NHK	103	95	90	82	76	72	69	12	380410800	
T 77, SL RT, SFP-S 70 mm octagonal steel shaft with slide over ring Ø 83 mm										
Meteor 20/17	34	32	30	27	25	24	23	17	380412100	
Meteor 20/17 mit NHK	34	32	30	27	25	24	23	17	240403300	
Gemini 25/17	43	40	38	34	32	30	29	17	380412200	
Gemini 25/17 mit NHK	43	40	38	34	32	30	29	17	240403400	
Apollo 30/17	52	48	45	41	38	36	35	17	380412300	
Mariner 40/17	69	63	60	54	51	48	46	17	380412400	
Mariner 40/17 mit NHK	69	63	60	54	51	48	46	17	380410100	
Vega 60/12	103	95	90	82	76	72	69	12	380411200	
Vega 60/12 mit NHK	103	95	90	82	76	72	69	12	380410800	
T 77, SL RT, SFP-S with 125 mm steel winding shaft										
Meteor 20/17	34	32	30	27	25	24	23	17	380412100	
Meteor 20/17 mit NHK	34	32	30	27	25	24	23	17	240403300	
Gemini 25/17	43	40	38	34	32	30	29	17	380412200	
Gemini 25/17 mit NHK	43	40	38	34	32	30	29	17	240403400	
Apollo 30/17	52	48	45	41	38	36	35	17	380412300	
Mariner 40/17	69	63	60	54	51	48	46	17	380412400	
Mariner 40/17 mit NHK	69	63	60	54	51	48	46	17	380410100	
Vega 60/12	103	95	90	82	76	72	69	12	380411200	
Vega 60/12 mit NHK	103	95	90	82	76	72	69	12	380410800	
Sirius 80/12	102	97	94	89	86	83	78	12	380411300	
Sirius 80/12 mit NHK	102	97	94	89	86	83	78	12	380410200	
Titan 100/12	127	121	118	112	107	104	98	12	380411400	
Titan 100/12 mit NHK	127	121	118	112	107	104	98	12	380410300	
Taurus 120/12	153	146	141	134	129	125	117	12	380411800	
Taurus 120/12 mit NHK	153	146	141	134	129	125	117	12	380411900	

	Product description	article no.	p.u. m	Unit	price €
	Joint bearing with loop 7 mm hexagonal pin length 315 mm, 45° - 90° diversion	382000100	1	pce	
	Angle crank for emergency crank handle, removable				
	120 cm	382020200	1	pce	
	163 cm	382020100	1	pce	
	Clamp holder PVC				
	clamp grey	249220400	1	pce	
	Bearing plate				
	for shaft bolt with ball bearing steel, galvanized 100 x 100 mm 42 mm intake	391030200	1	pce	
	Loop 165 mm				
	for Somfy motor with emergency crank handle	382010100	1	pce	
	Loop 225 mm				
	for Somfy motor with emergency crank handle	382010200	1	pce	





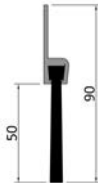

	Product description	article no.	p.u. m	Unit	price €
	Lock for emergency crank handle incl. Rosette, screws and guide sleeve				
	silver anodized EV 1	380370400	1	pce	
	Emergency crank handle, lockable for leftroller doors				
	complete set (consists of: crank, linkage and release lock)	382033400	1	pce	

	Product description	article no.	p.u. m	Unit	price €
	Push-button surface mounted, IP 44 for roller door control				
		380310100	1	pce	
	Key push-button/switch "Universal" surface mounted for roller doors with control - switch for roller doors without control - push-button				
		380320700	1	pce	
	Key push-button/switch "Universal" flush mounted for roller doors with control - switch for roller doors without control - push-button				
		380320800	1	pce	
	Push-button surface mounted				
	button	249310100	1	pce	
	Push-button flush mounted				
	button	249312400	1	pce	

	Product description	article no.	p.u. m	Unit	price €
	Clamp box for OSE 1.0 with spiral cable				
	made of PVC black	380210400	1	pce	
	Multiple control relay				
	for operation of one motor with two push-but- tons	380350100	1	pce	
	Roll up protection				
	PVC 25 x 215 mm 1 piece needed per SBK	391050100	1	pair	
	Filling brush				
	brush heigth 50 mm, total heigth 90 mm 300 cm	391010100	1	pce	



ROLLER DOOR CONTROL TOPDRIVE.2 AND ACCESSORIES

ALUKON

	Product description	article no.	p.u. m	Unit	price €
	Roller door control RTS TopDrive.2, without handheld transmitter	380013700	1	pce	
	Mini handheld transmitter BHS121, 2-channel 868 MHz	393160500	1	pce	
	Mini handheld transmitter BHS140, 4-channel 868 MHz	393160700	1	pce	
	Digicode radio controlled BHS 591, 4-channel 868 MHz	393161400	1	pce	
	Indoor button radio controlled BHS 421, 2-channel 868 MHz	393161500	1	pce	
	Handheld transmitter Blue Car2 BHS221, 2-channel 868 MHz - for cigarette lighter - (not in stock)	393160600	1	pce	

ROLLER DOOR CONTROL TOPDRIVE.2 AND ACCESSORIES

ALUKON

	Product description	article no.	p.u. m	Unit	price €
	Timer SC18180easy, plug-in (not in stock)	380031900	1	pce	
	Reflex photoelectric barrier RL52 including reflector and cable to be used as light barrier	380120500	1	pce	
	Light barrier modul OSE-C2300 for insert protection for roller door control TopDrive.2	380013800	1	pce	
	one-way light barrier RAY-S1101 including transmitter, receiver, cable for roller grills as insert protection upside	380120400	1	pce	

COMPONENTS FOR EMERGENCY CRANK HANDLE WITH INSIDE LINKAGE AND SECURITY LOCK OUTSIDE

ALUKON

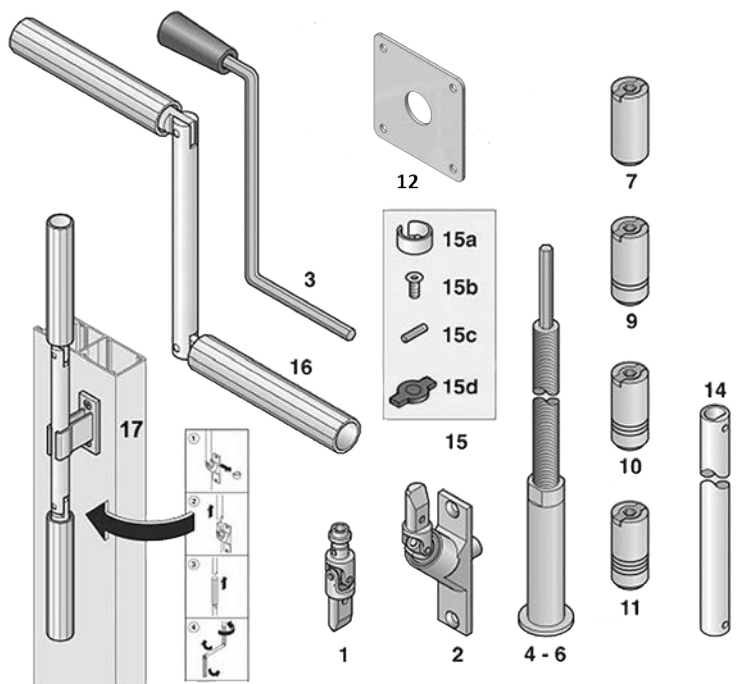

	Product description	article no.	p.u. m	Unit	price €
	1 Cardan joint for emergency crank handle, upper part	382030100	1	pce	
	2 joint bearing for emergency crank handle, lower part	382030200	1	pce	
	3 Crank for emergency crank handle -outside operation-	382030300	1	pce	
	4 Crank leadthrough, length 30 cm, for wall thickness 12 - 30 cm	382033100	1	pce	
	5 Crank leadthrough, length 45 cm, for wall thickness 30 - 40 cm	382033200	1	pce	
	6 Crank leadthrough, length 56 cm, for wall thickness 40 - 50 cm	382033300	1	pce	
	7 Mounting bush for RTF 90	382030400	1	pce	
	Mounting bush for RTF 150.2 / 100	382030600	1	pce	
	10 Mounting bush for GTF 750/75	382031100	1	pce	
	11 Mounting bush for GTF 850	382031200	1	pce	
	12 Cover for crank leadthrough	382030800	1	pce	
	connection tube aluminium white	240302400	6	m	
	15 Mounting set for emergency crank handle - exit outside a) mounting clip b) PIAS-drilling screw counter sunk 4,8 x 16 mm c) locking pin 3 x 12 mm d) screw-in tool for mounting bush	382030700	1	pce	
	16 Crank for inside operation of the emergency crank handle (with label)	382031300	1	pce	
	clamp white	249220500	1	pce	

