

Einbaurichtung RT hier: DIN rechts

Darstellung:
Tür geöffnet

Bestellbreite



ALUKON

Sonnenschutz Rollladen Insektenschutz



PLANUNGSHANDBUCH – INSEKTENSCHUTZ

FÜR FENSTER, TÜREN UND LICHTSCHÄCHTE

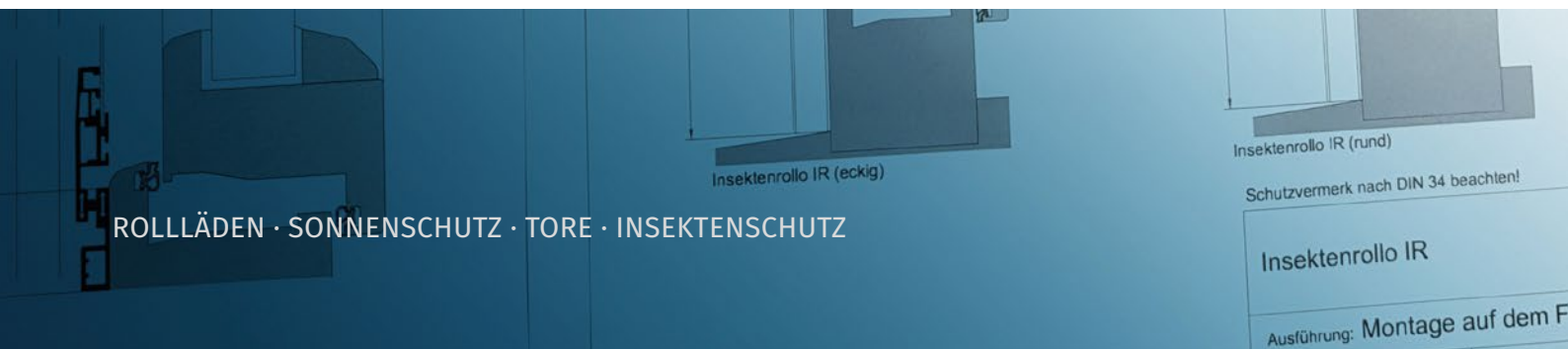

ALUKON

Sonnenschutz Rollläden Insektenschutz

Diese Unterlagen finden Sie
in ständig aktualisierter
Ausführung unter:



INSEKTENSCHUTZ VON ALUKON

PROFILÖSUNGEN FÜR ALLE FENSTER UND TÜREN

Die modernen Insektenschutzlösungen von ALUKON bieten Ihnen langlebigen Schutz und Flexibilität im Einsatz. Nahezu alle Fenster, Türen sowie Keller und Lichtschächte lassen sich mit den hochwertigen und stabilen Insektenschutzprodukten ausstatten und schützen so sicher und zuverlässig über viele Jahre vor Insekten.

Alle Spannrahmen und Insektenschutzrollos für Fenster sowie Dreh-, Pendel-, Schiebe- oder Plisseetüren, werden nach Ihren Wünschen individuell auf Maß gefertigt. Mit einer großen Auswahl an Insektengewebearten und der ALUKON Farbvielfalt für stranggepresste Aluminiumprofile findet sich für jedes Fenster und jede Tür die passende Lösung.

**Weitere Produkte und Neuheiten finden Sie auch auf
WWW.ALUKON.COM**



So erreichen Sie uns:

Postanschrift: **ALUKON KG**

KONRADSREUTH
Münchberger Straße 31
D-95176 Konradsreuth

HAIGERLOCH
Am Griesbaum 1
D-72401 Haigerloch

Telefon:

+49 9292 950-0

+49 7474 3914-0

Telefax:

+49 9292 950-5201

+49 7474 3914-700

Telefon Architektenberatung

+49 9292 950-201

E-Mail:

architektenberatung@alukon.com

Internet:

www.alukon.com

INHALTSVERZEICHNIS

ALLGEMEINES	6
<hr/>	
INSEKTENSCHUTZPROGRAMM	
SPANNRAHMEN	8
<hr/>	
INSEKTENSCHUTZROLLO	22
<hr/>	
RAHMEN- UND PENDELTÜR	26
<hr/>	
SCHIEBETÜR	40
<hr/>	
LICHTSCHACHTABDECKUNG	58
<hr/>	

ALLGEMEINES

OBERFLÄCHENBESCHAFFENHEIT

ALUKON Produkte werden für höchste Qualitätsanforderungen gefertigt.

Die beschichteten Aluminiumprodukte entsprechen den Einstufungskriterien der internationalen Qualitätsrichtlinien für die Beschichtung von Bauteilen aus Aluminium, GSB AL 631 – Ausgabe Januar 2012 und den Qualitätskriterien der Bewitterungsklasse „SEA Proof“. Der geforderte Nachweis über die Auslagerung im küstennahem Industrieklima nach Stufe 4 wurde durch eine Freibewitterung in Hoek van Holland geliefert. ALUKON setzt ein entsprechend zertifiziertes Vorbehandlungssystem ein.

ALUKON Produkte erfüllen die Anforderungen der Produktnorm der DIN EN 13659. Darin wird hinsichtlich der Korrosionsbeständigkeit die Mindestklasse 2 gefordert (Tabelle 12 – Klassen der Korrosionsbeständigkeit).

Bei Druckgussbauteilen aus Aluminium, insbesondere Blendkappen, kann es aufgrund ihrer metallischen Zusammensetzung, unter besonderen korrosiven Umweltbedingungen, zu einem schnelleren Abbau der Lackbeständigkeit kommen. Um eine höhere Seelufttauglichkeit zu erreichen, bietet ALUKON zusätzlich Blendkappen mit einer neuartigen Grundierung an.

Von der Seelufttauglichkeit auf eine dauerhafte „Seeluftbeständigkeit“ zu schließen, ist nicht möglich. Bei oberflächenbeschichteten Aluminiumbauteilen kann keine generelle Seeluftbeständigkeit erreicht und somit auch nicht gewährleistet werden.

Bitte beachten Sie hierzu auch die TR 121 (Technische Richtlinie) des Bundesverbandes Rollläden + Sonnenschutz e.V. Unter Punkt 3 wird erklärt, dass es unter Witterungs- und Chemikalien-Einflüssen, wie z. B. salzhaltiger Luft, im Laufe der Zeit zu sichtbaren Störungen der Oberflächengüte kommen kann.

Diese optische Einschränkung wirkt sich in der Regel nicht auf die Funktion des Rollladens aus.



30 RAL-FARBEN UND DB 703 OHNE MEHRPREIS IN GLÄNZENDER, MATTER UND STRUKTUR-LACKBESCHICHTUNG FÜR ALLE STRANGGEPRESSTEN PRODUKTE UND DRUCKGUSSTEILE

ALUKON RAL-Farbkollektion

in glänzender, matter und Strukturlackbeschichtung

Sämtliche anderen RAL-Farben, sowie rollgeformte Blenden, Fertigelemente mit rollgeformten Kästen in RAL, alle stranggepressten Rollladenprofile, Tore und Fertigpanzer sind von dieser Sonderregelung ausgeschlossen.

ALUKON Standardfarben

detaillierte Angaben in unseren Preislisten

www RAL-Farbkollektion

in glänzender, matter und Strukturlackbeschichtung



























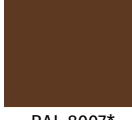

RAL Classic-Farben K7

in glänzender Oberfläche

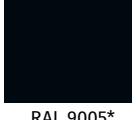

Sonderfarben und herstellerbezogene Farbtöne

nach Verfügbarkeit

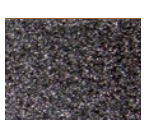
				
RAL 1015* hellelfenbein	RAL 3004* purpurrot	RAL 3005 weinrot	RAL 5011 stahlblau	RAL 6005* moosgrün
				
RAL 6009* tannengrün	RAL 7001 silbergrau	RAL 7004* signalgrau	RAL 7012* basaltgrau	RAL 7015 schiefergrau
				
RAL 7016 anthrazitgrau	RAL 7021* schwarzgrau	RAL 7022* umbragrau	RAL 7035* lichtgrau	RAL 7037 staubgrau
				
RAL 7038 achatgrau	RAL 7039* quarzgrau	RAL 8001* ockerbraun	RAL 8003* lehm Braun	RAL 8007* rehbraun
				
RAL 8017* schokoladenbraun	RAL 8019* graubraun	RAL 8022 schwarzbraun	RAL 9001 cremeweiß	RAL 9005* tiefschwarz
				
RAL 9006* weißaluminium	RAL 9007* graualuminium	RAL 9010* reinweiß	RAL 9016 verkehrsweiß	
				
6768* braun matt und struktur	DB 703 eisenglimmer matt und struktur			

* bei matter Oberfläche hochwetterfeste Beschichtung
Farbabweichungen sind drucktechnisch bedingt.
Keine Haftung für Druckfehler. Änderungen vorbehalten.

Oberflächenqualitäten

Alle Aluminium-Oberflächen sind langlebig, leicht zu reinigen und verfügen über Fassadentauglichkeit mit guter Licht- und Witterungsbeständigkeit. Alle Produkte werden in unserer eigenen hochmodernen Pulverbeschichtungsanlage in den gewünschten Farben und Oberflächenqualitäten beschichtet - Made in Germany.



SPANNRAHMEN

OHNE GROßEN AUFWAND MIT EINEM GRIFF

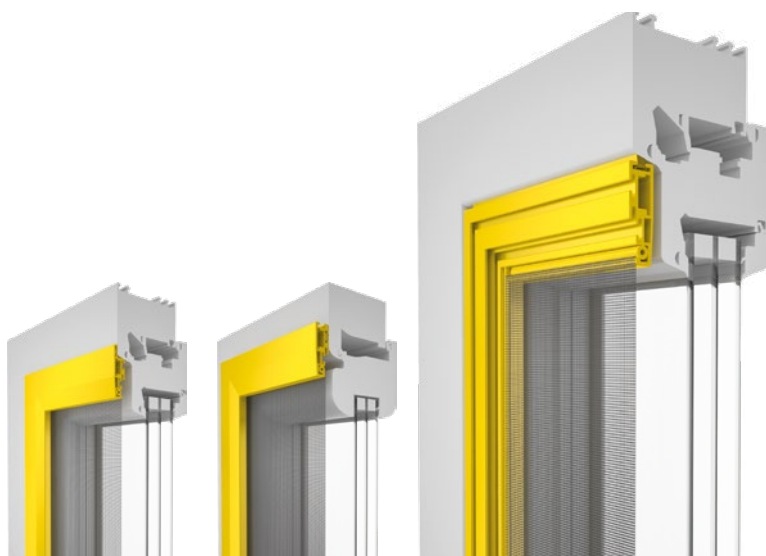

SP-V

für flächen-
versetzte Fenster

SP-B

für flächen-
bündige Fenster

SP-F

für flächenversetzte Fenster
mit Federstift



ALLGEMEINES

SPANNRAHMEN

INSEKTENSCHUTZROLLO



RAHMEN- UND PENDELTÜR

SCHIEBETÜR

LICHTSCHACHTABDECKUNG

SPANNRAHMEN

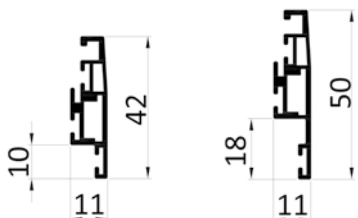
SP-V FÜR FLÄCHENVERSETZTE FENSTER

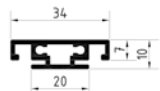
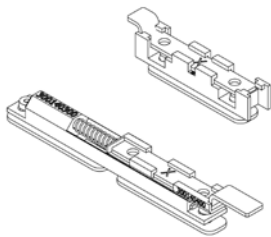
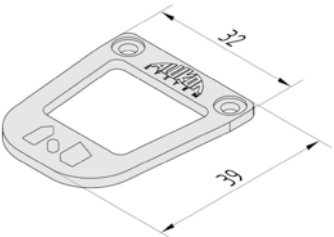
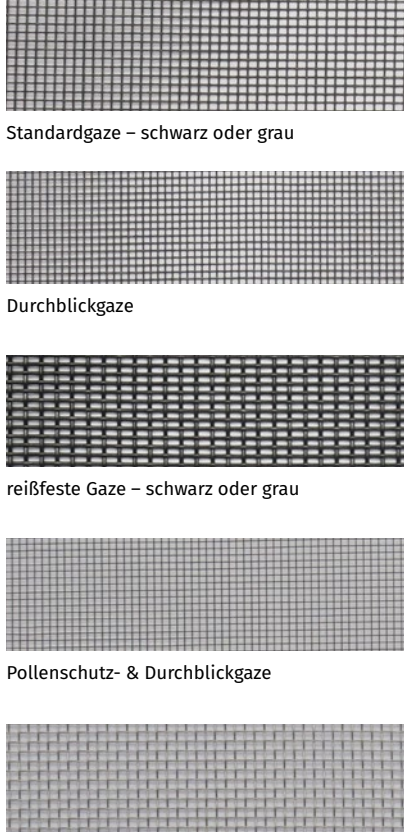
Rahmenprofile	Rahmenfarbe	Elementgrößen																																																																																								
 <p>Standardprofil 10 mm Sonderprofil 18 mm</p>	<p>Standardfarben</p>  <p>weiß braun SF</p> <p>RAL-Farben</p>  <p>ALUKON sonstige RAL-Farben RAL-Farbkollektion gegen Mehrpreis</p>	<table border="1"> <thead> <tr> <th>Breite</th> <th>50</th> <th>60</th> <th>...</th> <th>160</th> <th>170</th> <th>...</th> <th>max. 200</th> </tr> </thead> <tbody> <tr> <th>Höhe</th> <td></td> <td></td> <td></td> <td></td> <td></td> <td></td> <td></td> </tr> <tr> <td>50</td> <td></td> <td></td> <td></td> <td></td> <td></td> <td></td> <td></td> </tr> <tr> <td>60</td> <td></td> <td></td> <td></td> <td></td> <td></td> <td></td> <td></td> </tr> <tr> <td>...</td> <td></td> <td></td> <td></td> <td></td> <td></td> <td></td> <td></td> </tr> <tr> <td>150</td> <td></td> <td></td> <td></td> <td></td> <td></td> <td></td> <td></td> </tr> <tr> <td>160</td> <td></td> <td></td> <td></td> <td></td> <td></td> <td></td> <td></td> </tr> <tr> <td>170</td> <td></td> <td></td> <td></td> <td></td> <td></td> <td></td> <td></td> </tr> <tr> <td>...</td> <td></td> <td></td> <td></td> <td></td> <td></td> <td></td> <td></td> </tr> <tr> <td>...</td> <td></td> <td></td> <td></td> <td></td> <td></td> <td></td> <td></td> </tr> <tr> <td>max. 200</td> <td></td> <td></td> <td></td> <td></td> <td></td> <td></td> <td></td> </tr> </tbody> </table> <p>Maße in cm</p> <p>bei Rahmengrößen über 1600 mm wird zusätzlich mittig ein Stabilisierungsprofil montiert.</p>  <p>Stabilisierungsprofil</p>	Breite	50	60	...	160	170	...	max. 200	Höhe								50								60								...								150								160								170															max. 200							
Breite	50	60	...	160	170	...	max. 200																																																																																			
Höhe																																																																																										
50																																																																																										
60																																																																																										
...																																																																																										
150																																																																																										
160																																																																																										
170																																																																																										
...																																																																																										
...																																																																																										
max. 200																																																																																										
<p>Edelstahlhaken & Schlitten</p>	<p>Griffflaschen (transparent)</p>	<p>Gazenauswahl</p>																																																																																								
<p>zur Befestigung des Spannrahmens am Fenster</p>  <p>ab 1300 mm Höhe werden zusätzlich zwei lange Haken zur Mittelarretierung montiert.</p>	 <p>zum leichteren Ein- und Aushängen des Spannrahmens</p>	 <p>Standardgaze – schwarz oder grau</p> <p>Durchblickgaze</p> <p>reißfeste Gaze – schwarz oder grau</p> <p>Pollenschutz- & Durchblickgaze</p> <p>Edelstahlgaze</p>																																																																																								

Einbaubeispiele

SP-V 10

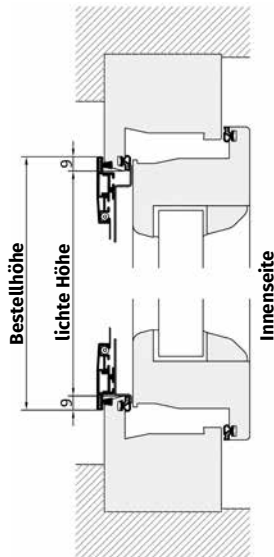
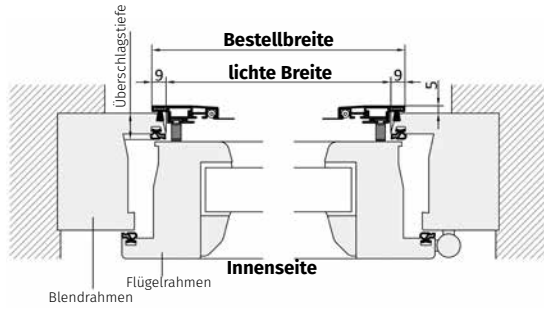



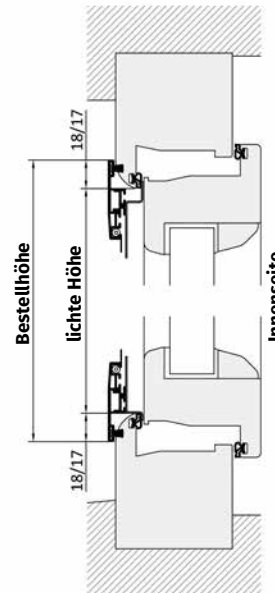
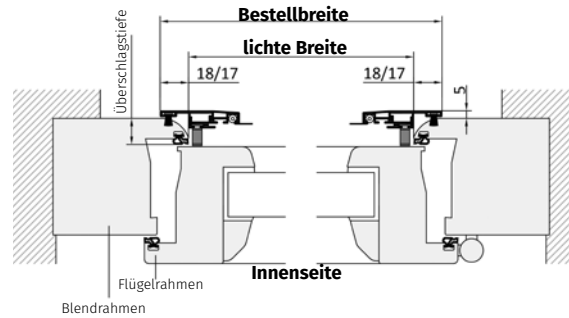





SP-V 18

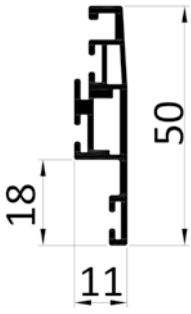
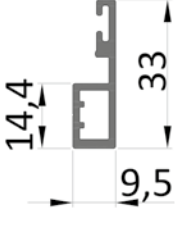

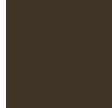
Softline Fenster:
 Bestellbreite = lichte Breite/ Höhe + 36 mm (18 je Seite)
 Standard Fenster:
 Bestellbreite = lichte Breite/ Höhe + 34 mm (17 je Seite)

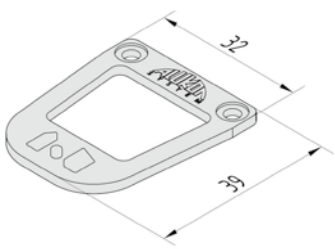
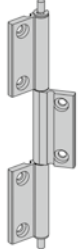
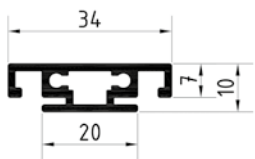
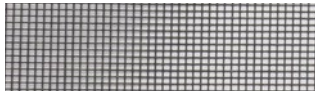
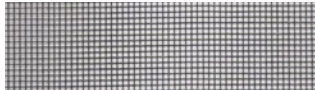
SPANNRAHMEN

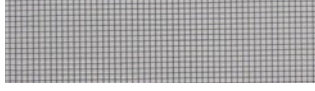
DREHRAHMEN DR-V FÜR FENSTER

Flügelprofil	Rahmenprofil (optional)	Rahmenfarbe
	 <p>umlaufender Blendrahmen</p>	<p>Standardfarben</p> <div style="display: flex; justify-content: space-around;"> <div style="text-align: center;">  weiß </div> <div style="text-align: center;">  braun SF </div> </div> <p>RAL-Farben</p> <div style="display: flex; justify-content: space-around;"> <div style="text-align: center;">  ALUKON RAL-Farbkollektion </div> <div style="text-align: center;">  sonstige RAL-Farben gegen Mehrpreis </div> </div>
<p>max. Elementgrößen: Breite 1300 mm Höhe 2000 mm Bei Elementgrößen über 1800 mm wird zusätzlich mittig ein Stabilisierungsprofil montiert.</p>		
Griffflaschen (transparent)	Scharniere	Stabilisierungsprofil
 <p>zum leichteren Ein- und Aushängen des Drehrahmens</p>	 <p>silber eloxiert</p>	 <p>Ab 1800 mm Höhe notwendig.</p>
Gazenauswahl		
<div style="display: flex; flex-direction: column; align-items: center;"> <div style="margin-bottom: 10px;">  Standardgaze – schwarz oder grau </div> <div style="margin-bottom: 10px;">  Durchblickgaze </div> <div style="margin-bottom: 10px;">  reißfeste Gaze – schwarz oder grau </div> <div style="margin-bottom: 10px;">  Pollenschutz- & Durchblickgaze </div> <div style="margin-bottom: 10px;">  Edelstahlgaze </div> </div>		

Einbaubeispiele

ohne Rahmen

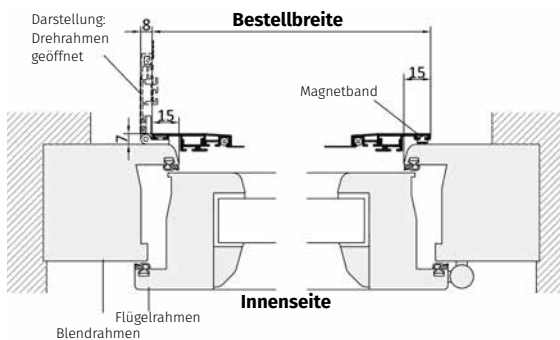



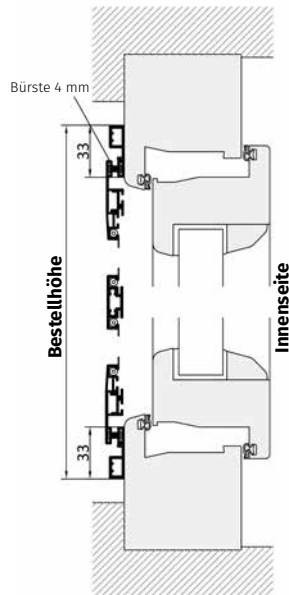
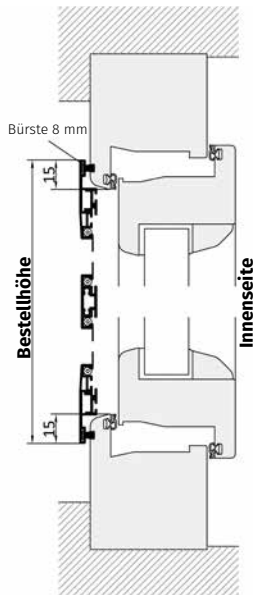
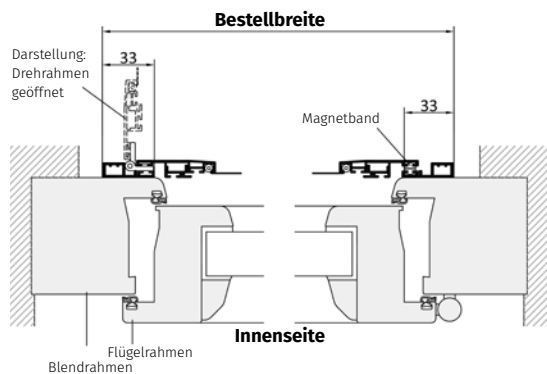





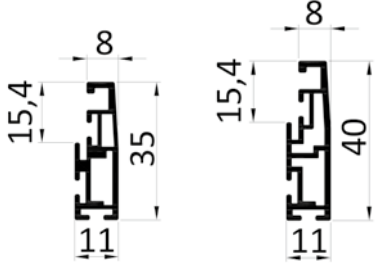

mit umlaufenden Rahmen

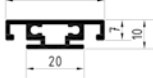
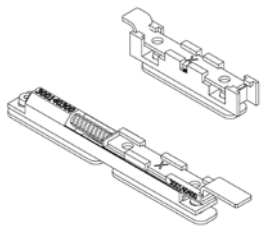
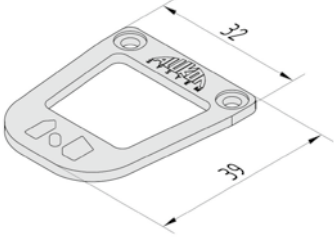

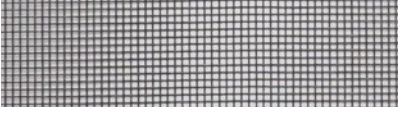
SPANNRAHMEN

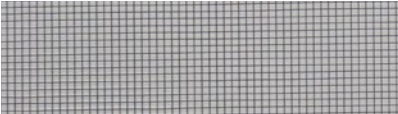
SP-B 35 UND 40 FÜR FLÄCHENBÜNDIGE UND FLÄCHENVERSETZTE FENSTER

Rahmenprofile	Rahmenfarbe	Elementgrößen																																																																																
 <p>Standardprofil 35 mm Sonderprofil 40 mm</p>	<p>Standardfarben</p>  <p>weiß braun SF</p> <p>RAL-Farben</p>  <p>ALUKON sonstige RAL-Farben RAL-Farbkollektion gegen Mehrpreis</p> 	<table border="1"> <thead> <tr> <th>Breite</th> <th>50</th> <th>60</th> <th>...</th> <th>150</th> <th>160</th> <th>...</th> <th>max. 200</th> </tr> </thead> <tbody> <tr> <th>Höhe</th> <td></td> <td></td> <td></td> <td></td> <td></td> <td></td> <td></td> </tr> <tr> <td>50</td> <td></td> <td></td> <td></td> <td></td> <td></td> <td></td> <td></td> </tr> <tr> <td>60</td> <td></td> <td></td> <td></td> <td></td> <td></td> <td></td> <td></td> </tr> <tr> <td>...</td> <td></td> <td></td> <td></td> <td></td> <td></td> <td></td> <td></td> </tr> <tr> <td>150</td> <td></td> <td></td> <td></td> <td></td> <td></td> <td></td> <td></td> </tr> <tr> <td>160</td> <td></td> <td></td> <td></td> <td></td> <td></td> <td></td> <td></td> </tr> <tr> <td>170</td> <td></td> <td></td> <td></td> <td></td> <td></td> <td></td> <td></td> </tr> <tr> <td>...</td> <td></td> <td></td> <td></td> <td></td> <td></td> <td></td> <td></td> </tr> <tr> <td>max. 200</td> <td></td> <td></td> <td></td> <td></td> <td></td> <td></td> <td></td> </tr> </tbody> </table> <p>Maße in cm</p> <p>bei Rahmengrößen über 1500 mm wird zusätzlich mittig ein Stabilisierungsprofil montiert.</p>  <p>Stabilisierungsprofil</p>	Breite	50	60	...	150	160	...	max. 200	Höhe								50								60								...								150								160								170								...								max. 200							
Breite	50	60	...	150	160	...	max. 200																																																																											
Höhe																																																																																		
50																																																																																		
60																																																																																		
...																																																																																		
150																																																																																		
160																																																																																		
170																																																																																		
...																																																																																		
max. 200																																																																																		
<p>Edelstahlhaken & Schlitten</p> <p>zur Befestigung des Spannrahmens am Fenster</p>  <p>ab 1300 mm Höhe werden zusätzlich zwei lange Haken zur Mittelarretierung montiert.</p>	<p>Griffflaschen (transparent)</p>  <p>zum leichteren Ein- und Aushängen des Spannrahmens</p>	<p>Gazenauswahl</p>  <p>Standardgaze – schwarz oder grau</p>  <p>Durchblickgaze</p>  <p>reißfeste Gaze – schwarz oder grau</p>  <p>Pollenschutz- & Durchblickgaze</p>  <p>Edelstahlgaze</p>																																																																																

Einbaubeispiele

SP-B 35

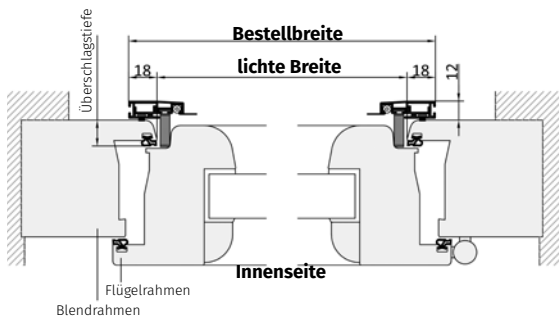



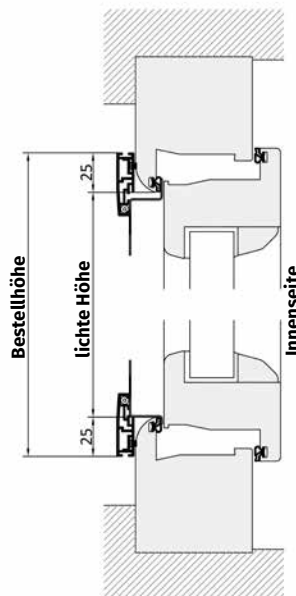
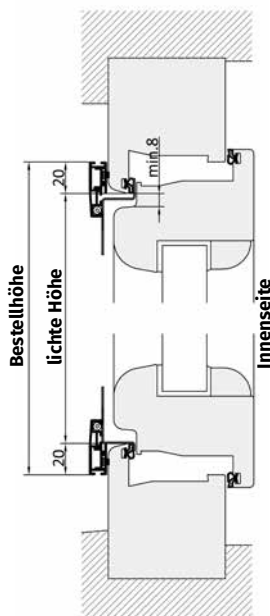
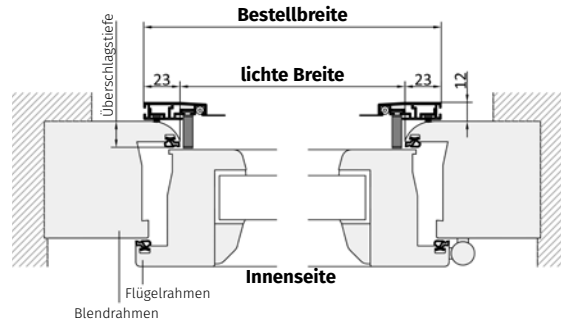



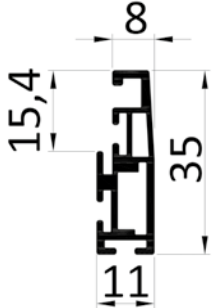
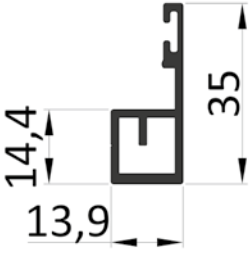

SP-B 40

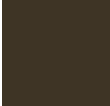

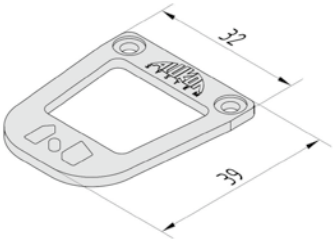
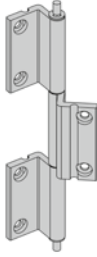
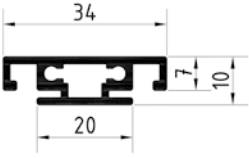
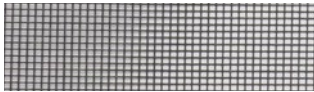
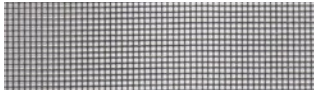
SPANNRAHMEN

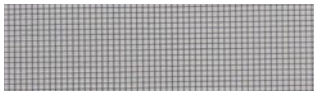
DREHRAHMEN DR-B FÜR FENSTER

Flügelprofil	Rahmenprofil (optional)	Rahmenfarbe
	 <p>umlaufender Blendrahmen</p>	<p>Standardfarben</p> <div style="display: flex; justify-content: space-around;"> <div style="text-align: center;">  weiß </div> <div style="text-align: center;">  braun SF </div> </div> <p>RAL-Farben</p> <div style="display: flex; justify-content: space-around;"> <div style="text-align: center;">  ALUKON RAL-Farbkollektion </div> <div style="text-align: center;">  sonstige RAL-Farben gegen Mehrpreis </div> </div>
<p>max. Elementgrößen: Breite 1300 mm Höhe 2000 mm Bei Rahmengrößen über 1800 mm wird zusätzlich mittig ein Stabilisierungsprofil montiert.</p>		
Griffflaschen (transparent)	Scharniere	Stabilisierungsprofil
 <p>zum leichteren Ein- und Aushängen des Drehrahmens</p>	 <p>silber eloxiert</p>	 <p>Ab 1800 mm Höhe notwendig.</p>
Gazenauswahl		
<div style="display: flex; flex-direction: column; align-items: center;"> <div style="margin-bottom: 10px;">  Standardgaze – schwarz oder grau </div> <div style="margin-bottom: 10px;">  Durchblickgaze </div> <div style="margin-bottom: 10px;">  reißfeste Gaze – schwarz oder grau </div> <div style="margin-bottom: 10px;">  Pollenschutz- & Durchblickgaze </div> <div style="margin-bottom: 10px;">  Edelstahlgaze </div> </div>		

Einbaubeispiele

ohne Rahmen

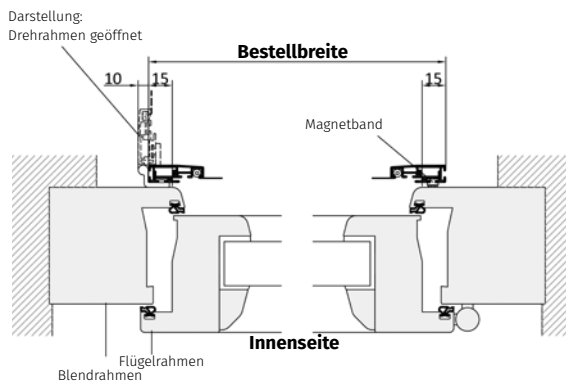



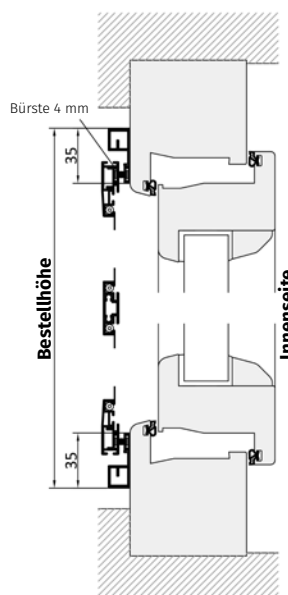
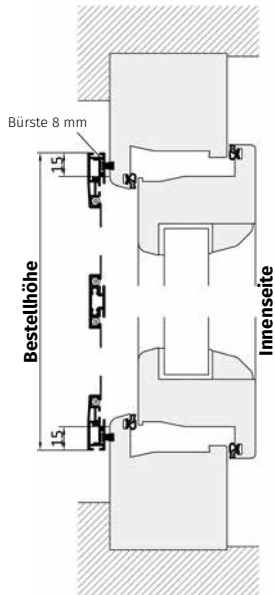
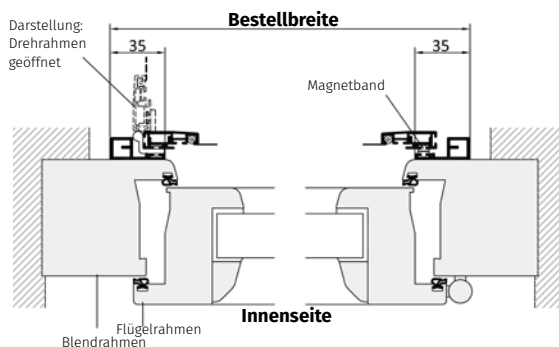





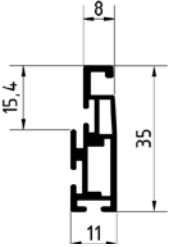

mit umlaufenden Rahmen

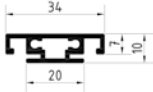
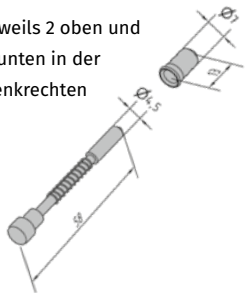
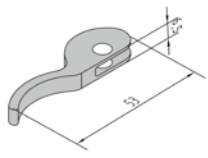
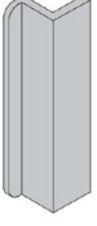

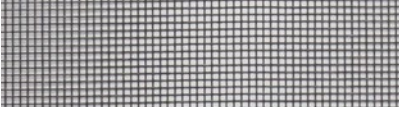
SPANNRAHMEN

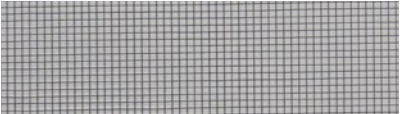
SP-F 35 FÜR SONDERLÖSUNGEN MIT FEDERSTIFTBEFESTIGUNGEN

Rahmenprofile	Rahmenfarbe	Elementgrößen																																																																								
 <p>Standardprofil 35 mm</p>	<p>Standardfarben</p> <div style="display: flex; justify-content: space-around;"> <div style="text-align: center;">  weiß </div> <div style="text-align: center;">  braun SF </div> </div> <p>RAL-Farben</p> <div style="display: flex; justify-content: space-around;"> <div style="text-align: center;">  ALUKON RAL-Farbkollektion </div> <div style="text-align: center;">  sonstige RAL-Farben gegen Mehrpreis </div> </div>	<table border="1" style="width: 100%; border-collapse: collapse;"> <thead> <tr> <th style="font-size: 8px;">Breite Höhe</th> <th style="font-size: 8px;">50</th> <th style="font-size: 8px;">60</th> <th style="font-size: 8px;">...</th> <th style="font-size: 8px;">150</th> <th style="font-size: 8px;">160</th> <th style="font-size: 8px;">...</th> <th style="font-size: 8px;">max. 200</th> </tr> </thead> <tbody> <tr><td style="font-size: 8px;">50</td><td></td><td></td><td></td><td></td><td></td><td></td><td></td></tr> <tr><td style="font-size: 8px;">60</td><td></td><td></td><td></td><td></td><td></td><td></td><td></td></tr> <tr><td style="font-size: 8px;">70</td><td></td><td></td><td></td><td></td><td></td><td></td><td></td></tr> <tr><td style="font-size: 8px;">...</td><td></td><td></td><td></td><td></td><td></td><td></td><td></td></tr> <tr><td style="font-size: 8px;">150</td><td></td><td></td><td></td><td></td><td></td><td></td><td></td></tr> <tr><td style="font-size: 8px;">160</td><td></td><td></td><td></td><td></td><td></td><td></td><td></td></tr> <tr><td style="font-size: 8px;">...</td><td></td><td></td><td></td><td></td><td></td><td></td><td></td></tr> <tr><td style="font-size: 8px;">max. 200</td><td></td><td></td><td></td><td></td><td></td><td></td><td></td></tr> </tbody> </table> <p style="text-align: right; font-size: 8px;">Maße in cm</p> <p>bei Rahmengrößen über 1500 mm wird zusätzlich mittig ein Stabilisierungsprofil montiert</p> <div style="display: flex; align-items: center;">  <div style="margin-left: 10px;">Stabilisierungsprofil</div> </div>	Breite Höhe	50	60	...	150	160	...	max. 200	50								60								70								...								150								160								...								max. 200							
Breite Höhe	50	60	...	150	160	...	max. 200																																																																			
50																																																																										
60																																																																										
70																																																																										
...																																																																										
150																																																																										
160																																																																										
...																																																																										
max. 200																																																																										
<p>Federstift und Federhülse</p> <p>zur Befestigung des Spannrahmens am Fenster</p> <p>jeweils 2 oben und 2 unten in der Senkrechten</p>   <p>Hebel optional wählbar</p>	<p>Griffflaschen</p>  <p>zum leichteren Ein- und Aushängen des Spannrahmens</p>	<p>Gazenauswahl</p>  <p>Standardgaze – schwarz oder grau</p>  <p>Durchblickgaze</p>  <p>reißfeste Gaze – schwarz oder grau</p>  <p>Pollenschutz- & Durchblickgaze</p>  <p>Edelstahlgaze</p>																																																																								

Einbaubeispiele

SP-F 35 in der Falz

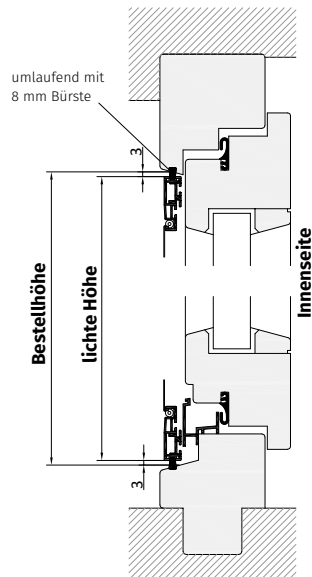
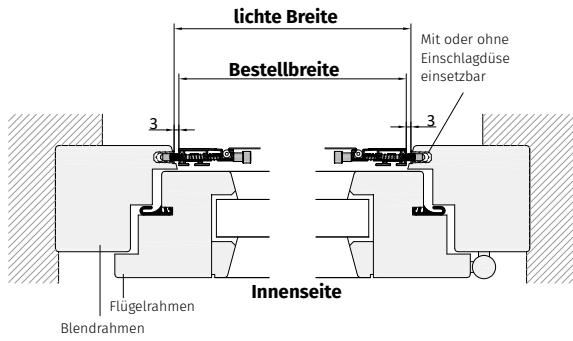

Variante 2: Wetterschenkel am Blendrahmen

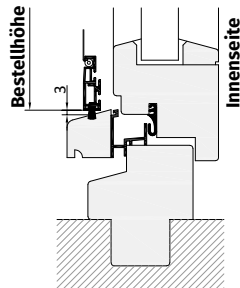



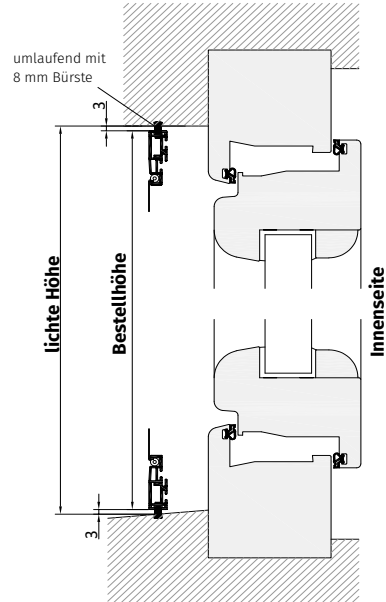
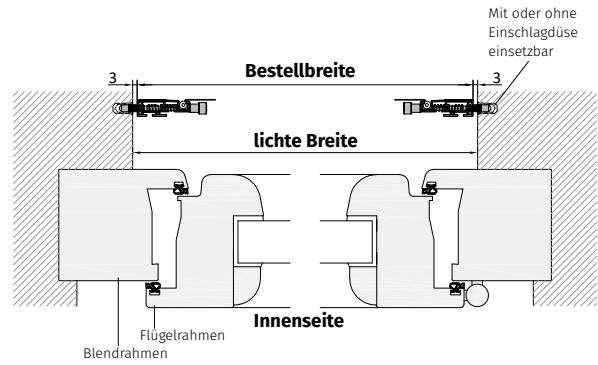





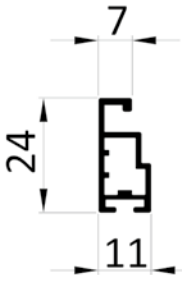

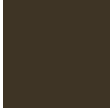
SP-F 35 in der Laibung

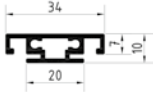
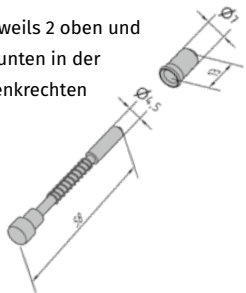
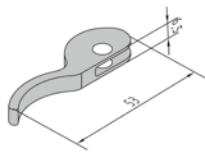
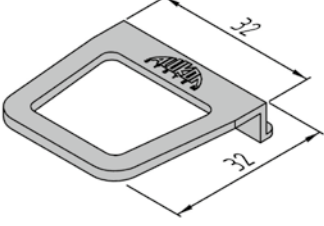

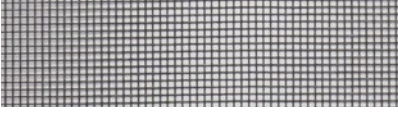
SPANNRAHMEN

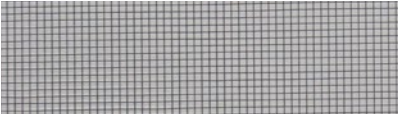
SP-F 24 FÜR SONDERLÖSUNGEN MIT FEDERSTIFTBEFESTIGUNGEN

Rahmenprofile	Rahmenfarbe	Elementgrößen																																																																																
 <p>Standardprofil 24 mm</p>	<p>Standardfarben</p> <div style="display: flex; justify-content: space-around;"> <div style="text-align: center;">  weiß </div> <div style="text-align: center;">  braun SF </div> </div> <p>RAL-Farben</p> <div style="display: flex; justify-content: space-around;"> <div style="text-align: center;">  ALUKON RAL-Farbkollektion </div> <div style="text-align: center;">  sonstige RAL-Farben gegen Mehrpreis </div> </div>	<table border="1" style="width: 100%; border-collapse: collapse;"> <thead> <tr> <th>Breite</th> <th>50</th> <th>...</th> <th>130</th> <th>140</th> <th>150</th> <th>...</th> <th>max. 200</th> </tr> </thead> <tbody> <tr> <td>Höhe</td> <td></td> <td></td> <td></td> <td></td> <td></td> <td></td> <td></td> </tr> <tr> <td>50</td> <td></td> <td></td> <td></td> <td></td> <td></td> <td></td> <td></td> </tr> <tr> <td>60</td> <td></td> <td></td> <td></td> <td></td> <td></td> <td></td> <td></td> </tr> <tr> <td>...</td> <td></td> <td></td> <td></td> <td></td> <td></td> <td></td> <td></td> </tr> <tr> <td>130</td> <td></td> <td></td> <td></td> <td></td> <td></td> <td></td> <td></td> </tr> <tr> <td>140</td> <td></td> <td></td> <td></td> <td></td> <td></td> <td></td> <td></td> </tr> <tr> <td>150</td> <td></td> <td></td> <td></td> <td></td> <td></td> <td></td> <td></td> </tr> <tr> <td>...</td> <td></td> <td></td> <td></td> <td></td> <td></td> <td></td> <td></td> </tr> <tr> <td>max. 200</td> <td></td> <td></td> <td></td> <td></td> <td></td> <td></td> <td></td> </tr> </tbody> </table> <p style="text-align: right;">Maße in cm</p> <p>bei Rahmengrößen über 1300 mm wird zusätzlich mittig ein Stabilisierungsprofil montiert</p> <div style="display: flex; align-items: center;">  <div style="margin-left: 10px;">Stabilisierungsprofil</div> </div>	Breite	50	...	130	140	150	...	max. 200	Höhe								50								60								...								130								140								150								...								max. 200							
Breite	50	...	130	140	150	...	max. 200																																																																											
Höhe																																																																																		
50																																																																																		
60																																																																																		
...																																																																																		
130																																																																																		
140																																																																																		
150																																																																																		
...																																																																																		
max. 200																																																																																		
<p>Federstift und Federhülse</p> <p>zur Befestigung des Spannrahmens am Fenster</p> <p>jeweils 2 oben und 2 unten in der Senkrechten</p>   <p>Hebel optional wählbar</p>	<p>Griffflaschen (transparent)</p>  <p>zum leichteren Ein- und Aushängen des Spannrahmens</p>	<p>Gazenauswahl</p>  <p>Standardgaze – schwarz oder grau</p>  <p>Durchblickgaze</p>  <p>reißfeste Gaze – schwarz oder grau</p>  <p>Pollenschutz- & Durchblickgaze</p>  <p>Edelstahlgaze</p>																																																																																

Einbaubeispiele

SP-F 24

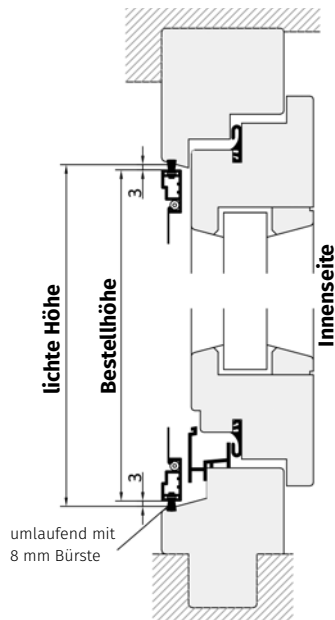
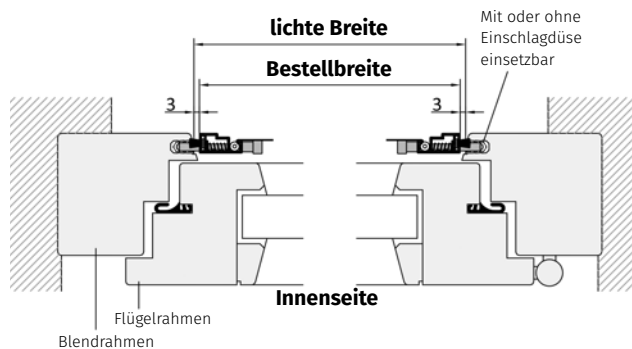

Variante 2: Wetterschenkel am Blendrahmen

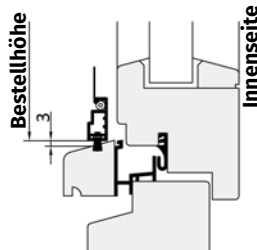



INSEKTENSCHUTZROLLO

LEICHTE UND BEQUEME BEDIENUNG

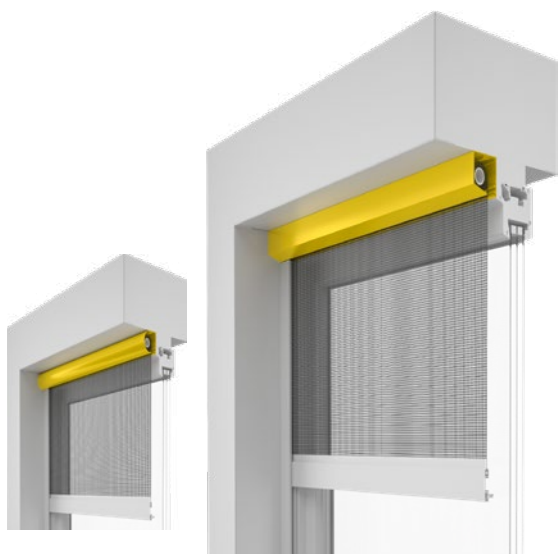



RUND

ECKIG

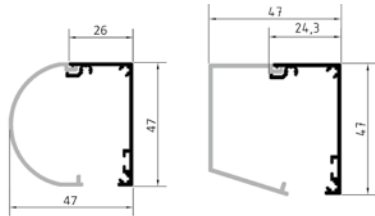
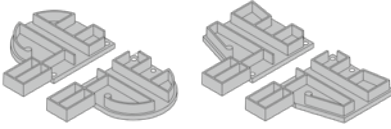

INSEKTENSCHUTZROLLO

INSEKTENSCHUTZROLLO IR

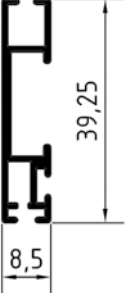
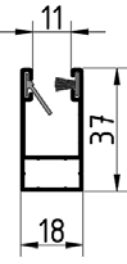
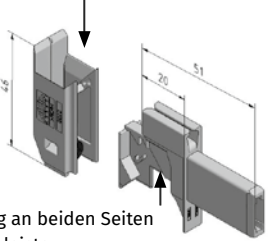
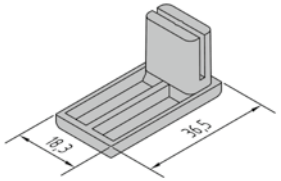
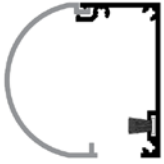
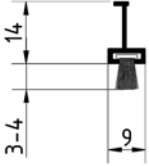
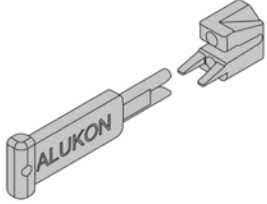
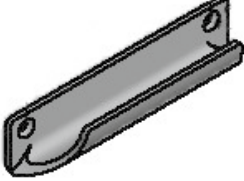
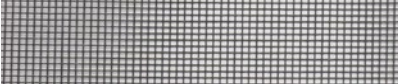
Kastenübersicht	PVC-Endkappen	Farbe
 <p>Rundkasten 20° abgeschrägter Kasten</p>	 <p>für Rundkasten für 20° abgeschrägten Kasten</p> <p>in weiß oder schwarz</p>	<p>Standardfarben</p>  <p>weiß braun SF</p> <p>RAL-Farben</p>  <p>ALUKON sonstige RAL-Farben gegen Mehrpreis</p> <p>RAL-Farbkollektion</p>
<p>max. Elementgrößen: Breite = 1800 mm Höhe = 2500 mm Fläche 3 m² / 2 m² Bei nicht windgeschützten Fenstern sollte die max. Fläche des Insektengitters 2 m² nicht überschreiten. Bei windgeschützten Fenstern sollte die max. Fläche des Insektengitters 3 m² nicht überschreiten</p>		
Schlussleiste	Führungsschiene	Easy-Click
 <p>Abdichtung erfolgt durch: Bürste hinten Bürste unten Teleskopprofil mit Bürste (siehe Zusatzausstattungen)</p>	 <p>A 23 mit Bürsteneinlage</p>	 <p>Befestigung an beiden Seiten der Schlussleiste</p> <p>ermöglicht eine leichte Verriegelung des Insektenschutzrollos beim Öffnen und Schließen</p>
Zusatzausstattungen		
 <p>PVC-Führungsschienenabschlüsse in weiß oder schwarz</p>	 <p>Kastenabdichtung mit 8 mm Bürste</p>	 <p>Teleskopprofil wird in die Schlussleistennut eingeschoben, dichtet nach unten ab</p>
 <p>Anschlag oben begrenzt den Weg des Rollos nach oben</p>	 <p>Griff für Schlussleiste Montagevariante vorm Dachflächenfenster</p>	<p>Gaze</p>  <p>Standardgaze – schwarz oder grau</p>

Einbaubeispiele

eckiger und runder Kasten

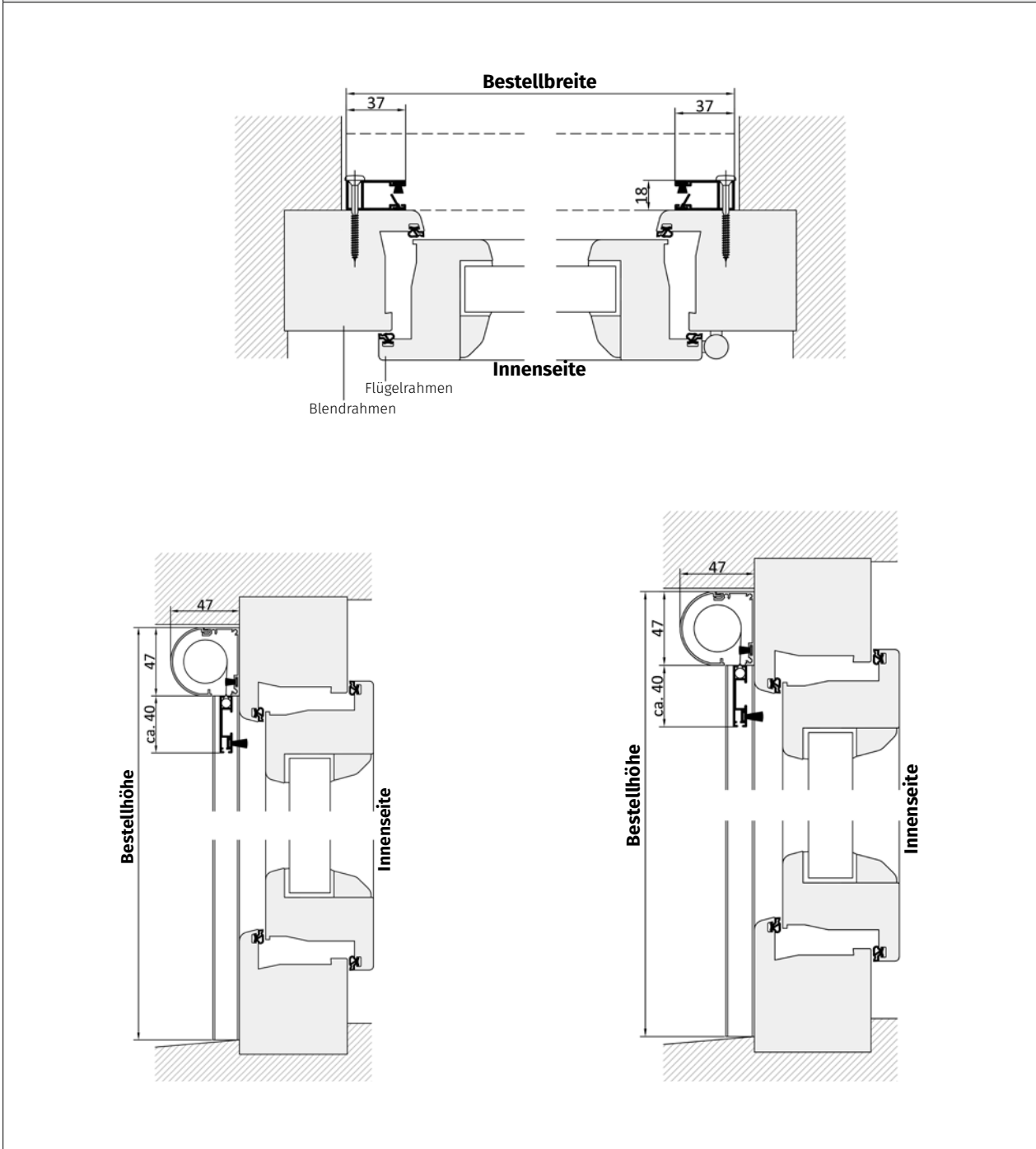

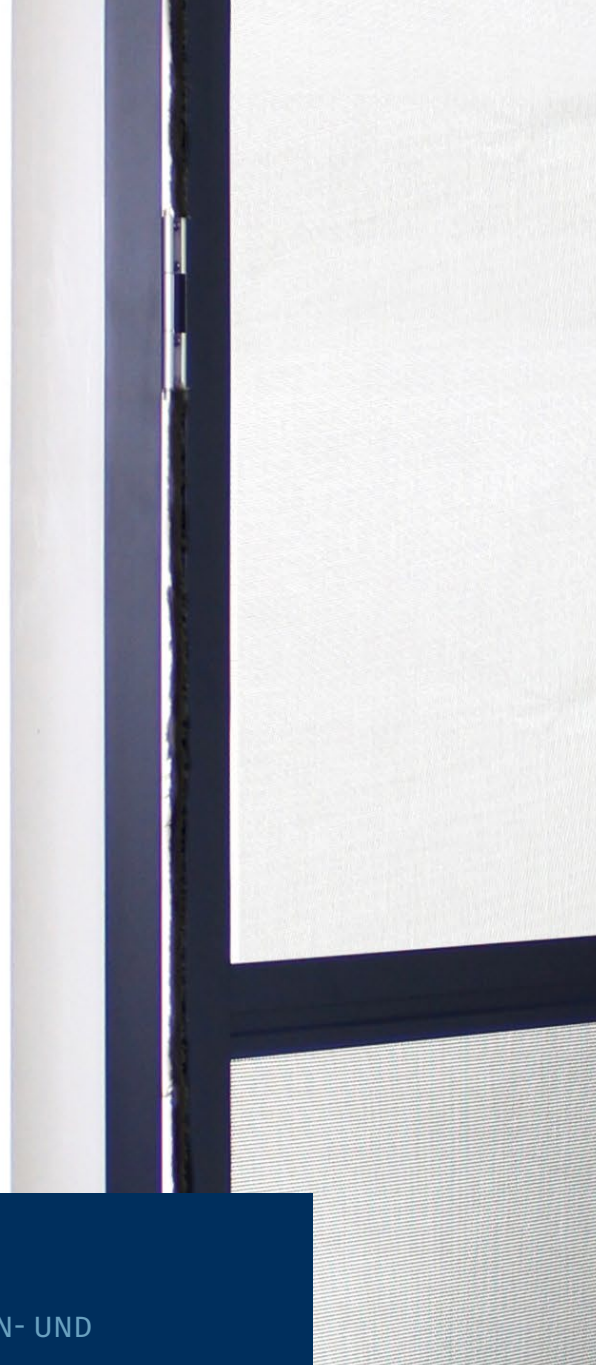

RAHMEN- UND PENDELTÜR



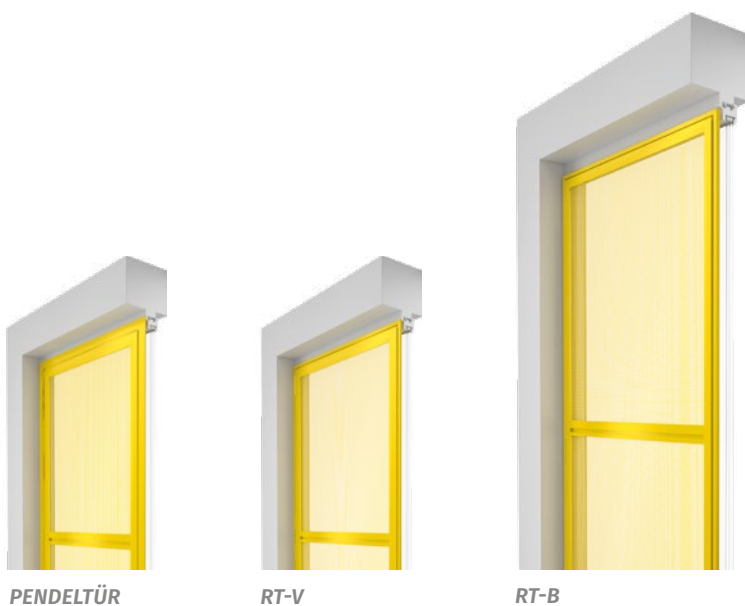

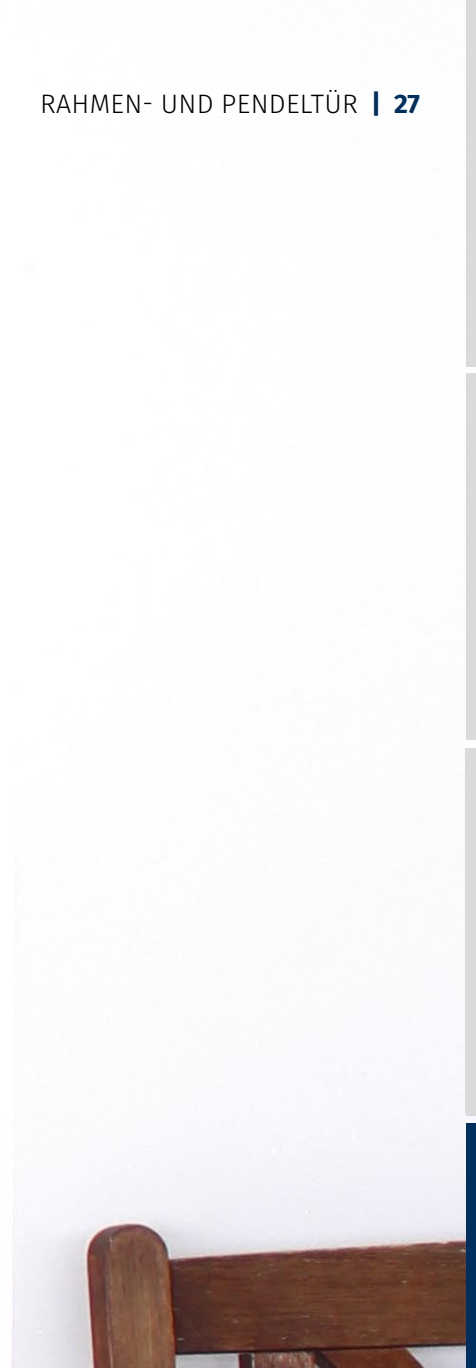

DAUERHAFTER UND BEQUEMER INSEKTENSCHUTZ FÜR BALKON- UND TERRASSENTÜREN



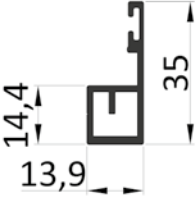

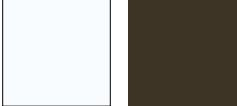
RAHMEN- UND PENDELTÜR

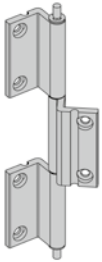
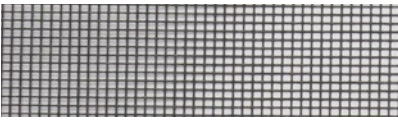
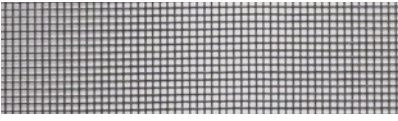
RAHMENTÜR RT-B

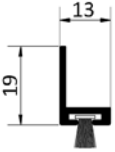
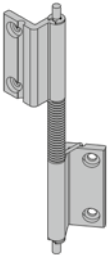
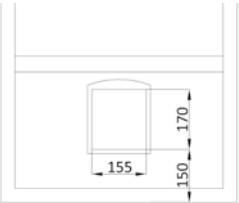
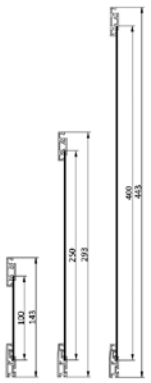
Flügelprofil	Rahmenprofil (optional)	Griffleiste	
 <p>mit integriertem Magnetband</p>	 <p>> umlaufend (4-seitig) > 3-seitig</p>	 <p>Die Griffleiste wird in einer Höhe von 900 mm gesetzt. Individuelle Positionen möglich.</p>	
<p>max. Elementgrößen: Breite = 1300 mm Höhe = 2500 mm</p>			
Farben	Scharniere	Gazenauswahl	
<p>Standardfarben</p>  <p>weiß braun SF</p> <p>RAL-Farben</p>  <p>ALUKON sonstige RAL-Farben RAL-Farbkollektion gegen Mehrpreis</p>	 <p>silber eloxiert</p>	 <p>Standardgaze – schwarz oder grau</p>  <p>Durchblickgaze</p>  <p>reißfeste Gaze – schwarz oder grau</p>	
Zusatzausstattungen			
 <p>L-Winkel mit 8 mm Bürste zum Ausgleich von Höhenunterschieden (zur Abdichtung des unteren Flügels)</p>	 <p>Federschließer (zum selbständigen Schließen der Tür)</p>	 <p>Katzenklappe in weiß (im unteren Stoßblech/ Trittschutz integriert)</p>	<p>mit Trittschutz 100, 250 und 400 mm</p> 

Einbaubeispiele

RT-B ohne Rahmen

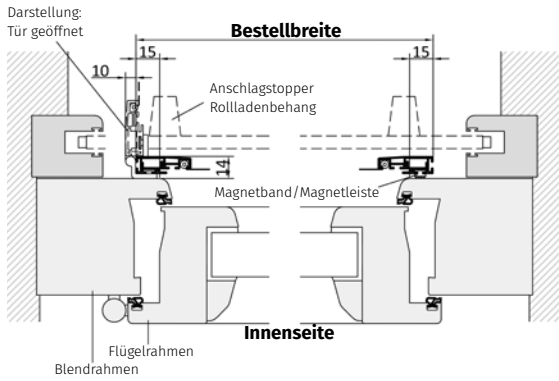



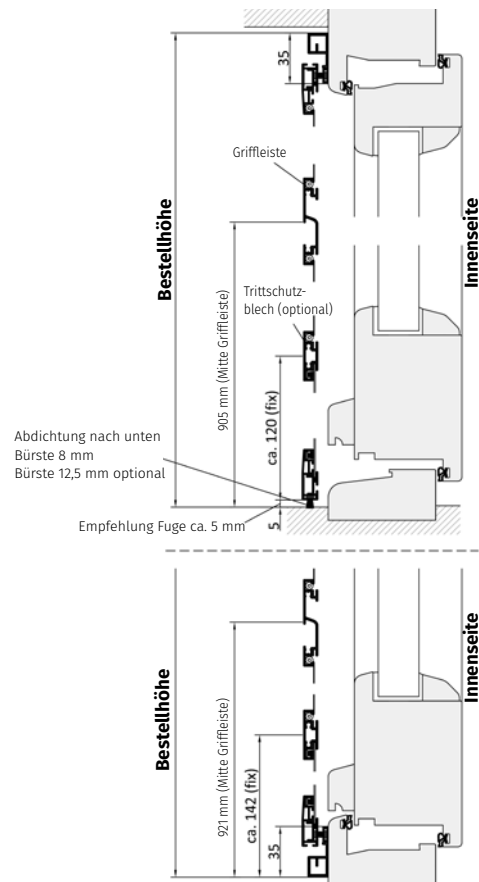
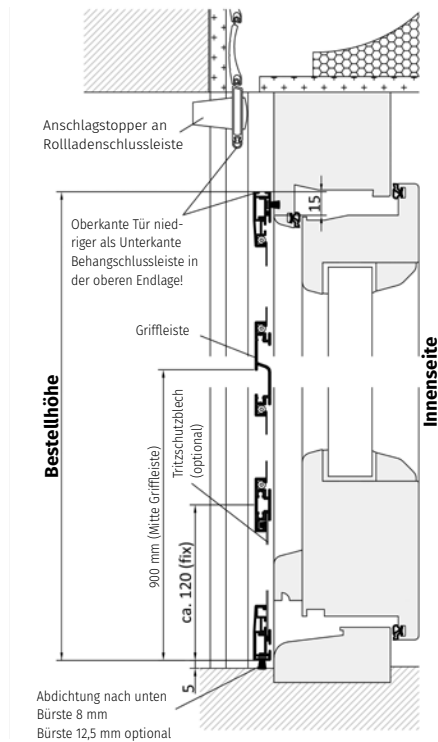
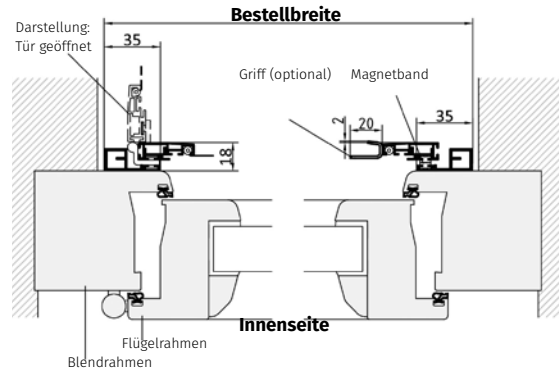



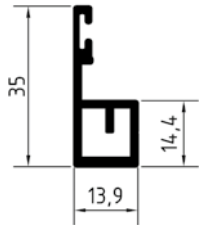

RT-B mit umlaufendem Rahmen (3- oder 4-seitig)

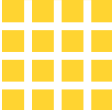

RAHMEN- UND PENDELTÜR

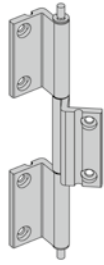
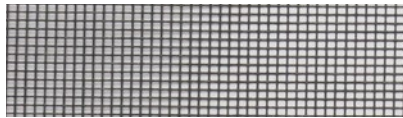
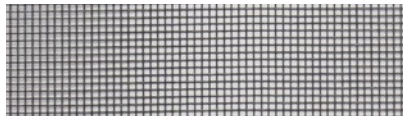
RAHMENTÜR RT-B ZWEIFLÜGELIG AUßENÖFFNEND

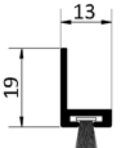
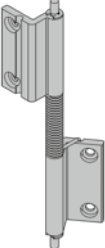
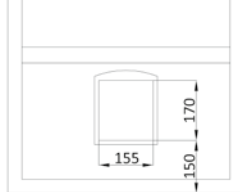
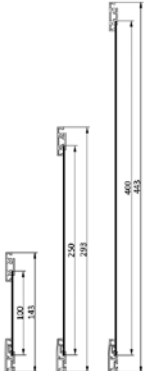
Flügelprofil	Rahmenprofil (optional)	Griffleiste	
 <p>mit integriertem Magnetband</p>	 <p>> umlaufend (4-seitig) > 3-seitig</p>	 <p>Die Griffleiste wird in einer Höhe von 900 mm gesetzt. Individuelle Positionen möglich.</p>	
<p>max. Elementgrößen: Breite = 2600 mm Höhe = 2500 mm</p>			
Farben	Scharniere	Gazenauswahl	
<p>Standardfarben</p> <div style="display: flex; justify-content: space-around;"> <div style="text-align: center;">  <p>weiß</p> </div> <div style="text-align: center;">  <p>braun SF</p> </div> </div> <p>RAL-Farben</p> <div style="display: flex; justify-content: space-around;"> <div style="text-align: center;">  <p>ALUKON RAL-Farbkollektion</p> </div> <div style="text-align: center;">  <p>sonstige RAL-Farben gegen Mehrpreis</p> </div> </div>	 <p>silber eloxiert</p>	 <p>Standardgaze – schwarz oder grau</p>  <p>Durchblickgaze</p>  <p>reißfeste Gaze – schwarz oder grau</p>	
Zusatzausstattungen			
 <p>L-Winkel mit 8 mm Bürste zum Ausgleich von Höhenunterschieden (zur Abdichtung des unteren Flügels)</p>	 <p>Federschließer (zum selbständigen Schließen der Tür)</p>	 <p>Katzenklappe in weiß (im unteren Stoßblech/ Trittschutz integriert)</p>	<p>mit Trittschutz 100, 250 und 400 mm</p> 





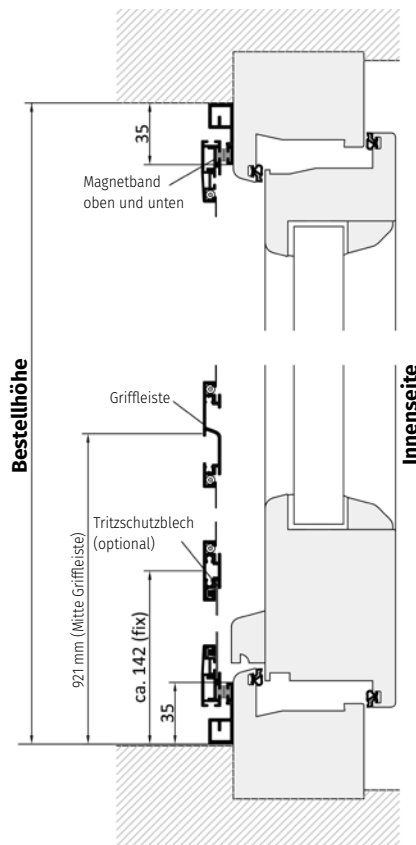
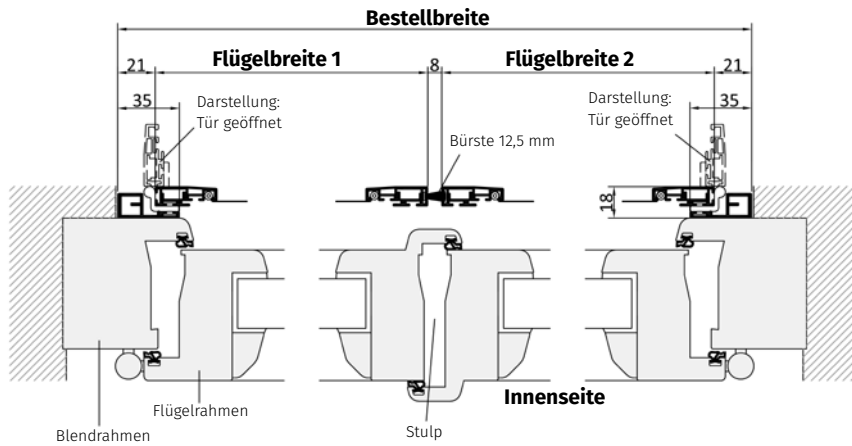

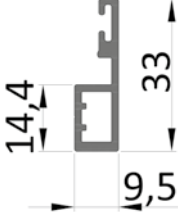
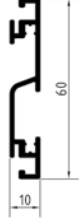

Einbaubeispiele

RT-B – zweiflügelig mit umlaufenden Rahmen

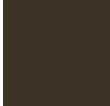

RAHMEN- UND PENDELTÜR

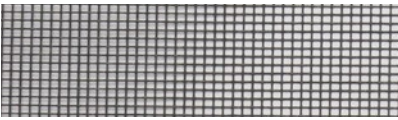
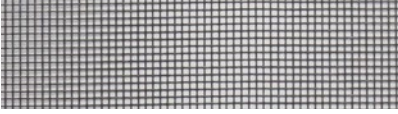
RAHMENTÜR RT-V

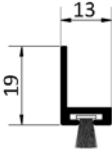
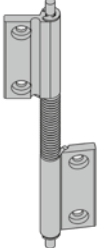
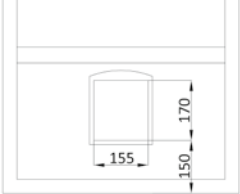
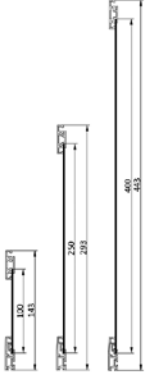
Flügelprofil	Rahmenprofil (optional)	Griffleiste	
 <p>mit integriertem Magnetband</p>	 <p>> umlaufend (4-seitig) > 3-seitig</p>	 <p>Die Griffleiste wird in einer Höhe von 900 mm gesetzt. Individuelle Positionen möglich.</p>	
<p>max. Elementgrößen: Breite = 1300 mm Höhe = 2500 mm</p>			
Farben	Scharniere	Gazenauswahl	
<p>Standardfarben</p> <div style="display: flex; justify-content: space-around;"> <div style="text-align: center;">  weiß </div> <div style="text-align: center;">  braun SF </div> </div> <p>RAL-Farben</p> <div style="display: flex; justify-content: space-around;"> <div style="text-align: center;">  ALUKON RAL-Farbkollektion </div> <div style="text-align: center;">  sonstige RAL-Farben gegen Mehrpreis </div> </div>	 <p>silber eloxiert</p>	 Standardgaze – schwarz oder grau  Durchblickgaze  reißfeste Gaze – schwarz oder grau	
Zusatzausstattungen			
 <p>L-Winkel mit 8 mm Bürste zum Ausgleich von Höhenunterschieden (zur Abdichtung des unteren Flügels)</p>	 <p>Federschließer (zum selbständigen Schließen der Tür)</p>	 <p>Katzenklappe in weiß (im unteren Stoßblech/ Trittschutz integriert)</p>	<p>mit Trittschutz 100, 250 und 400 mm</p> 

Einbaubeispiele

RT-V ohne Rahmen

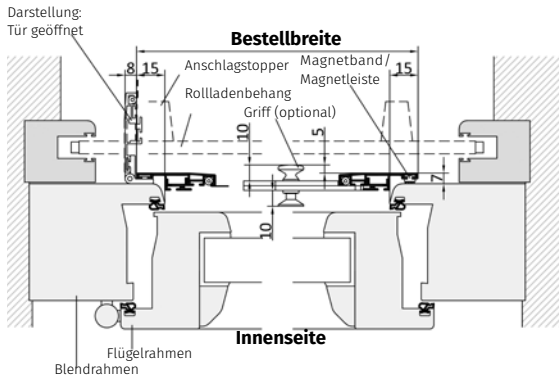

RT-V mit umlaufenden Rahmen (3- oder 4-seitig)

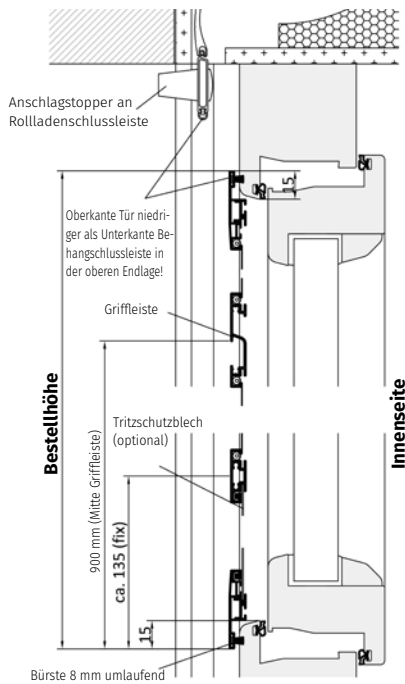
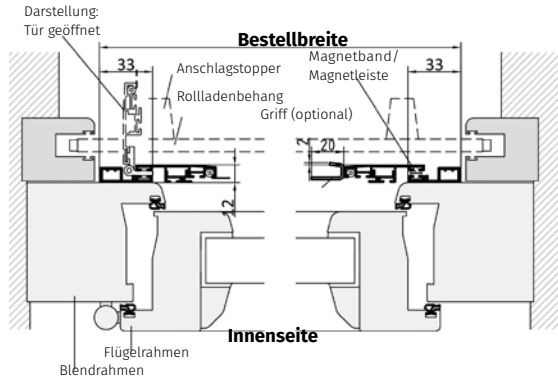

SP-B Profil zur Abdichtung nach unten. Bürste 8 mm oder Bürste 12,5 mm

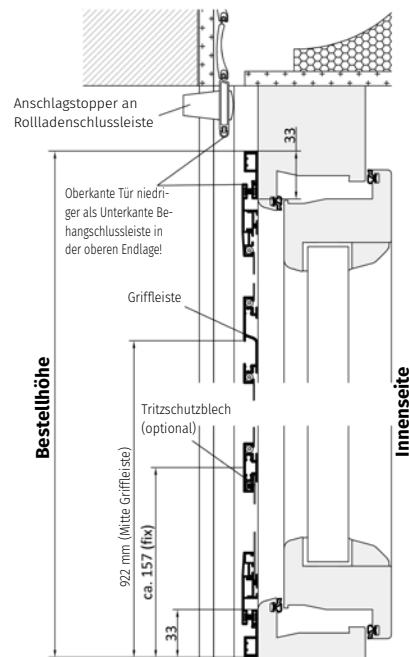
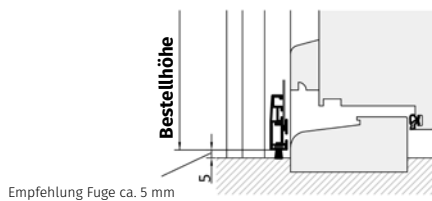



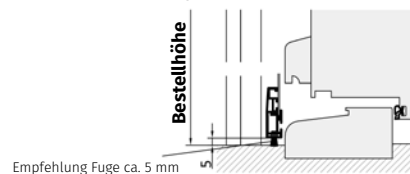



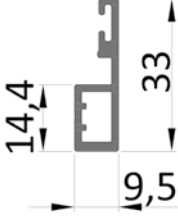
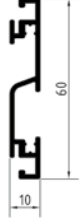

SP-B Profil zur Abdichtung nach unten. Bürste 8 mm oder Bürste 12,5 mm

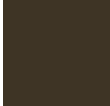

RAHMEN- UND PENDELTÜR

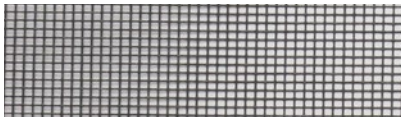
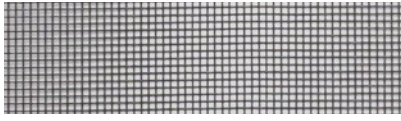
RAHMENTÜR RT-V ZWEIFLÜGELIG AUBENÖFFNEND

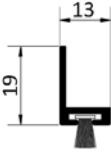
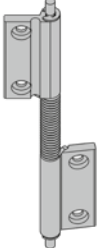
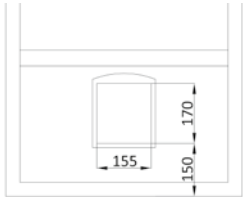
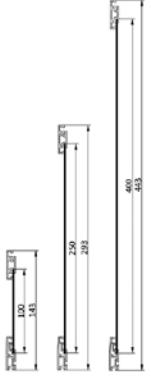
Flügelprofil	Rahmenprofil (optional)	Griffleiste	
 <p>mit integriertem Magnetband</p>	 <p>> umlaufend (4-seitig) > 3-seitig</p>	 <p>Die Griffleiste wird in einer Höhe von 900 mm gesetzt. Individuelle Positionen möglich.</p>	
<p>max. Elementgrößen: Breite = 2600 mm Höhe = 2500 mm</p>			
Farben	Scharniere	Gazenauswahl	
<p>Standardfarben</p> <div style="display: flex; justify-content: space-around;"> <div style="text-align: center;">  weiß </div> <div style="text-align: center;">  braun SF </div> </div> <p>RAL-Farben</p> <div style="display: flex; justify-content: space-around;"> <div style="text-align: center;">  ALUKON RAL-Farbkollektion </div> <div style="text-align: center;">  sonstige RAL-Farben gegen Mehrpreis </div> </div>	 <p>silber eloxiert</p>	 Standardgaze – schwarz oder grau  Durchblickgaze  reißfeste Gaze – schwarz oder grau	
Zusatzausstattungen			
 <p>L-Winkel mit 8 mm Bürste zum Ausgleich von Höhenunterschieden (zur Abdichtung des unteren Flügels)</p>	 <p>Federschließer (zum selbständigen Schließen der Tür)</p>	 <p>Katzenklappe in weiß (im unteren Stoßblech/ Trittschutz integriert)</p>	<p>mit Trittschutz 100, 250 und 400 mm</p> 





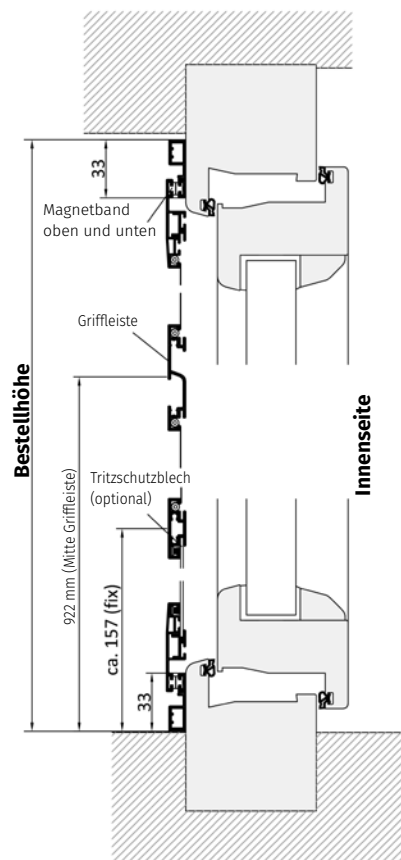
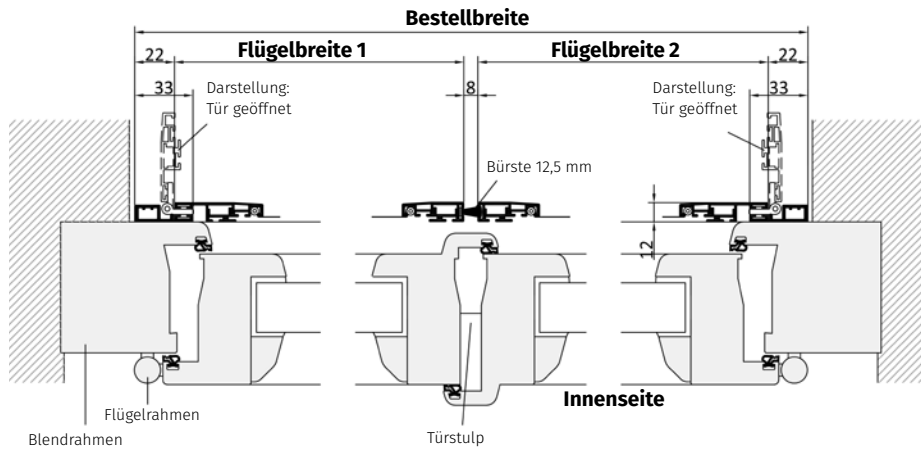



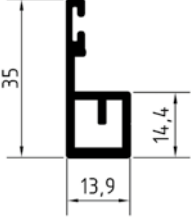

Einbaubeispiele

RT-V – zweiflügelig mit umlaufenden Rahmen

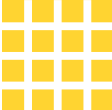

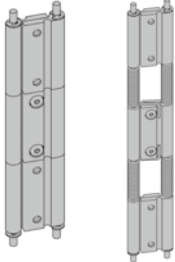
RAHMEN- UND PENDELTÜR

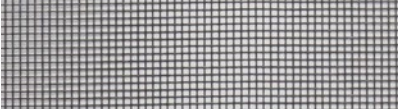
PENDELTÜR

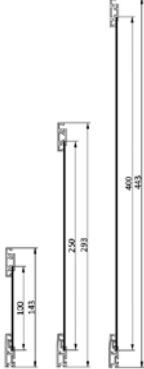
Flügelprofil	Rahmenprofil (erforderlich)	Griffleiste
 <p>mit integrierten Blockmagneten</p>	 <p>> umlaufend (4-seitig) > 3-seitig</p>	 <p>Die Griffleiste wird in einer Höhe von 900 mm gesetzt. Individuelle Positionen möglich.</p>
<p>max. Elementgrößen: Breite = 1100 mm Höhe = 2500 mm</p>		
Farben	Scharniere	Gazenauswahl
<p>Standardfarben</p> <div style="display: flex; justify-content: space-around;"> <div style="text-align: center;">  <p>weiß</p> </div> <div style="text-align: center;">  <p>braun SF</p> </div> </div> <p>RAL-Farben</p> <div style="display: flex; justify-content: space-around;"> <div style="text-align: center;">  <p>ALUKON RAL-Farbkollektion</p> </div> <div style="text-align: center;">  <p>sonstige RAL-Farben gegen Mehrpreis</p> </div> </div>		 <p>Standardgaze – schwarz oder grau</p>  <p>Durchblickgaze</p>  <p>reißfeste Gaze – schwarz oder grau</p>
Trittschutz (erforderlich)		
<p>100, 250 und 400 mm</p> 		





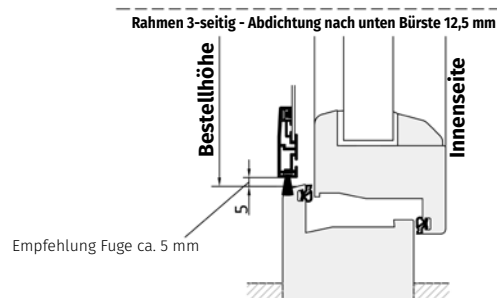
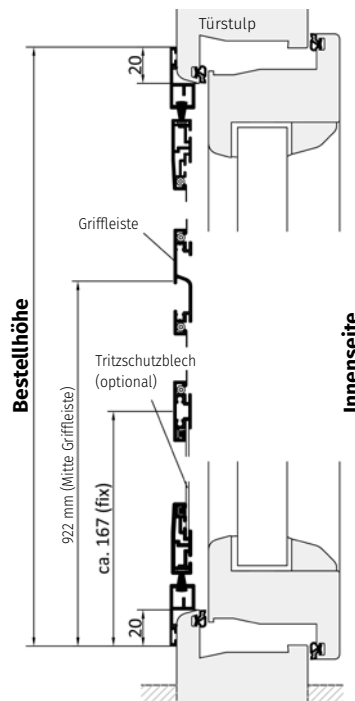
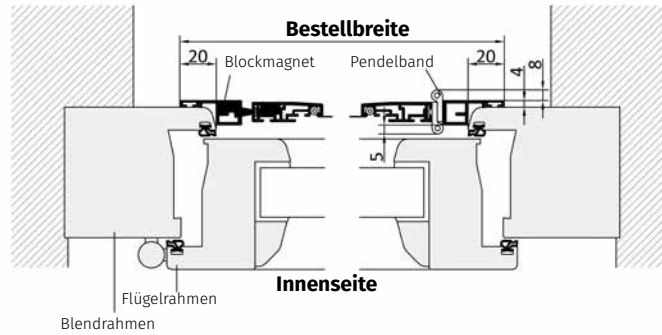

Einbaubeispiele

Pendeltür mit umlaufenden Rahmen (3- oder 4-seitig)

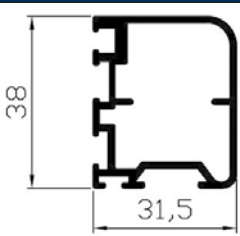
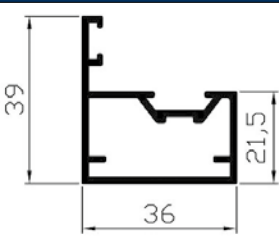
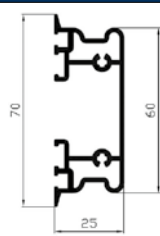

RAHMEN- UND PENDELTÜR

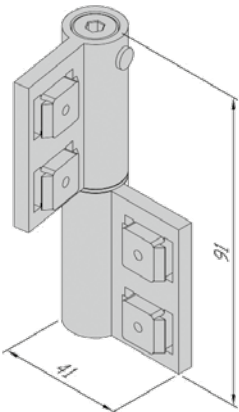
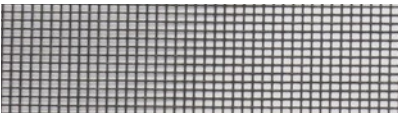
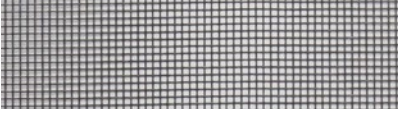
RAHMENTÜR RT 50

Flügelprofil	Rahmenprofil (erforderlich)	Griffleiste
	 <p>> umlaufend (4-seitig) > 3-seitig mit optionaler Bürste nach unten</p>	 <p>Die Griffleiste wird in einer Höhe von 900 mm gesetzt. Individuelle Positionen möglich.</p>
<p>max. Elementgrößen: Breite = 1300 mm Höhe = 2500 mm</p>		
Farben	Scharniere	Gazenauswahl
<p>Standardfarben</p> <div style="display: flex; justify-content: space-around;"> <div style="text-align: center;">  weiß </div> <div style="text-align: center;">  braun SF </div> </div> <p>RAL-Farben</p> <div style="display: flex; justify-content: space-around;"> <div style="text-align: center;">  ALUKON RAL-Farbkollektion </div> <div style="text-align: center;">  sonstige RAL-Farben gegen Mehrpreis </div> </div>	 <p style="text-align: center;">schwarz</p>	 Standardgaze – schwarz oder grau  Durchblickgaze  reißfeste Gaze – schwarz oder grau

Einbaubeispiele

RT 50 mit umlaufenden Rahmen (3- oder 4-seitig)

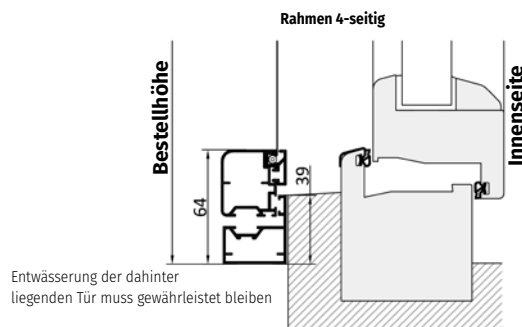
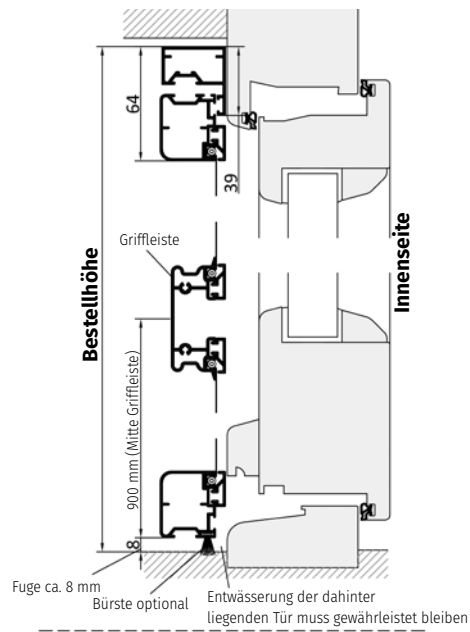
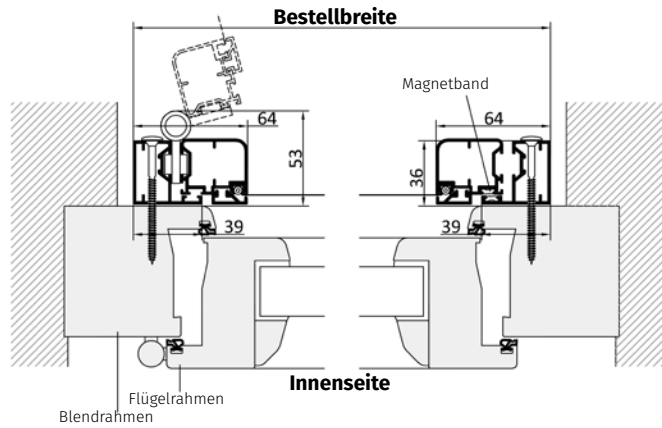



SCHIEBETÜR

DAUERHAFTER UND BEQUEMER INSEKTENSCHUTZ FÜR BALKON- UND TERRASSENTÜREN



SCHIEBETÜR







PLISSEETÜR

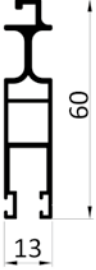
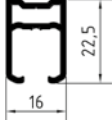
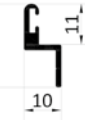
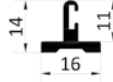
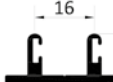
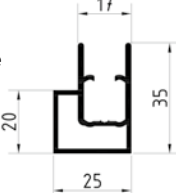
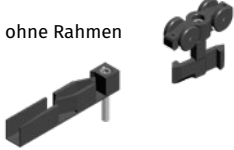
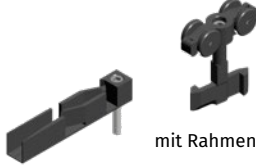

SCHIEBETÜR

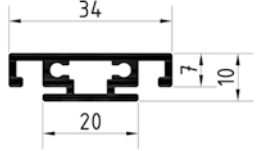
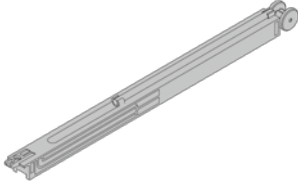
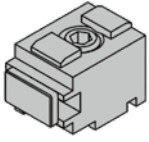
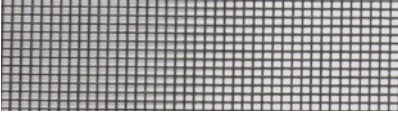
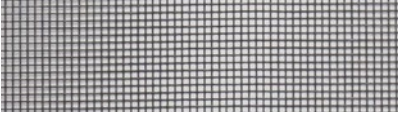
OBEN GELAGERT, 1-FLÜGELIG

Flügelprofil (inkl. Griffleiste)	Rahmenprofil	
	<p>Standard</p> <p>U-Profil oben</p>  <p>Z-Profil unten</p> 	 <p>T-Bodenschiene unten</p>  <p>U-Bodenschiene unten</p>  <p>Rahmenprofil 3- oder 4-seitig</p>
<p>max. Elementgröße: Anlagenbreite = 3600 mm Anlagenhöhe = 2600 mm</p> <p>Flügelbreite: standardmäßig die Hälfte der Anlagenbreite, Sonderkonstruktionen möglich. Standard: Anlagenbreite = 2000 mm => Flügelbreite 1000 mm Sonderbau: Anlagenbreite = 2000 mm => Flügelbreite 1300 mm Bei Flügelbreiten über 1500 mm wird zusätzlich mittig ein Stabilisierungsprofil montiert</p>		
Laufwagen + Quick-Slide	Farbe	Stabilisierungsprofil
<p>ohne Rahmen</p>  <p>mit Rahmen</p>  <p>Flügel werden mittels Laufwagen in der oberen Schiene geführt</p>	<p>Standardfarben</p>  <p>weiß braun SF</p> <p>RAL-Farben</p>  <p>ALUKON sonstige RAL-Farben RAL-Farbkollektion gegen Mehrpreis</p>	 <p>ab 1500 mm notwendig</p>
Dämpfung (optional)	Anschlag (optional)	Gazenauswahl
<p>Soft Close</p>  <p>dämpft den Schlag des des Flügels gegen den Rahmen</p>	<p>Anschlag für Flügel</p>  <p>begrenzt den Fahrweg des Flügels</p> <p>schwarz</p>	 <p>Standardgaze – schwarz oder grau</p>  <p>Durchblickgaze</p>  <p>reißfeste Gaze – schwarz oder grau</p>

Einbaubeispiele

mit U-Führung und Führung Z oder Bodenschiene

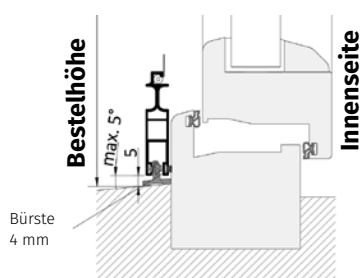
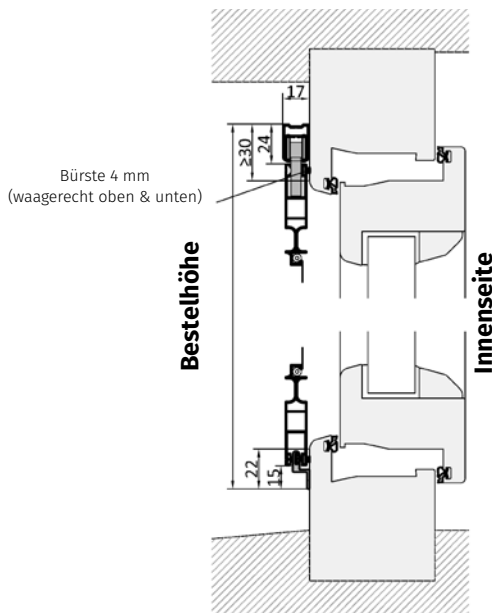
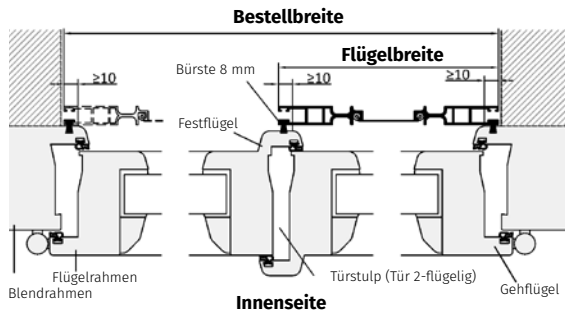



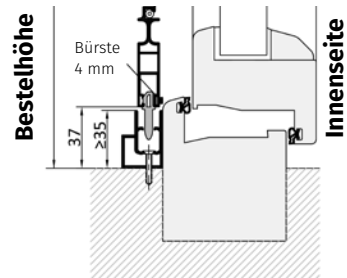
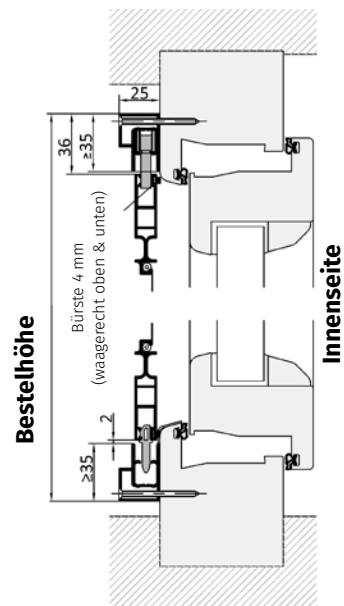
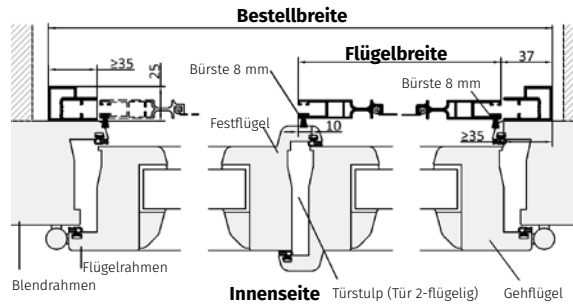



mit umlaufenden Rahmenprofil

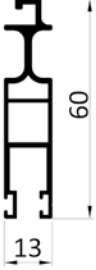
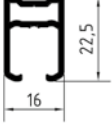
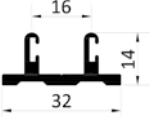
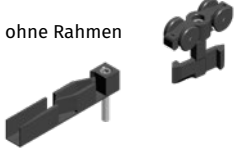
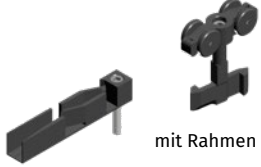

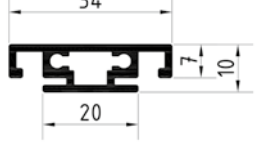
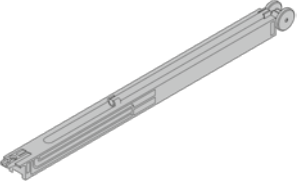
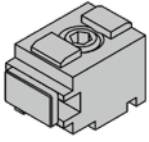
SCHIEBETÜR

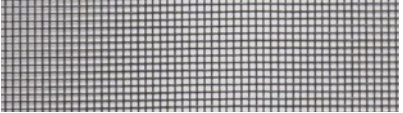
OBEN GELAGERT, 2-FLÜGELIG, PARALLEL LAUFEND

Flügelprofil (inkl. Griffleiste)	Rahmenprofil	
	<p>U-Profil oben</p> 	<p>U-Bodenschiene unten</p> 
<p>max. Elementgröße: Anlagenbreite = 3600 mm Anlagenhöhe = 2600 mm</p> <p>Flügelbreite: standardmäßig die Hälfte der Anlagenbreite, Sonderkonstruktionen möglich. Standard: Anlagenbreite = 2000 mm => Flügelbreite 1000 mm Sonderbau: Anlagenbreite = 2000 mm => Flügelbreite 1300 mm Bei Flügelbreiten über 1500 mm wird zusätzlich mittig ein Stabilisierungsprofil montiert</p>		
Laufwagen + Quick-Slide	Farbe	Stabilisierungsprofil
<p>ohne Rahmen</p>  <p>mit Rahmen</p>  <p>Flügel werden mittels Laufwagen in der oberen Schiene geführt</p>	<p>Standardfarben</p>  <p>weiß braun SF</p> <p>RAL-Farben</p>  <p>ALUKON sonstige RAL-Farben RAL-Farbkollektion gegen Mehrpreis</p>	 <p>ab 1500 mm notwendig</p>
Dämpfung (optional)	Anschlag (optional)	Gazenauswahl
<p>Soft Close</p>  <p>dämpft den Schlag des des Flügels gegen den Rahmen</p>	<p>Anschlag für Flügel</p>  <p>begrenzt den Verfahrweg des Flügels</p> <p>schwarz</p>	 <p>Standardgaze – schwarz oder grau</p>  <p>Durchblickgaze</p>  <p>reißfeste Gaze – schwarz oder grau</p>



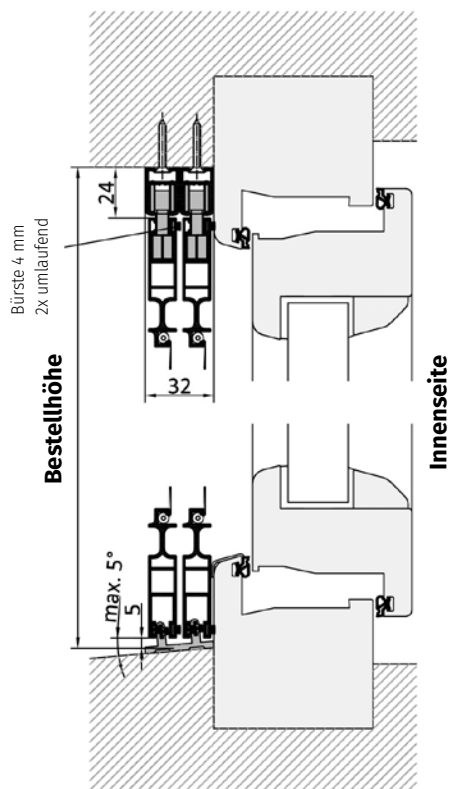
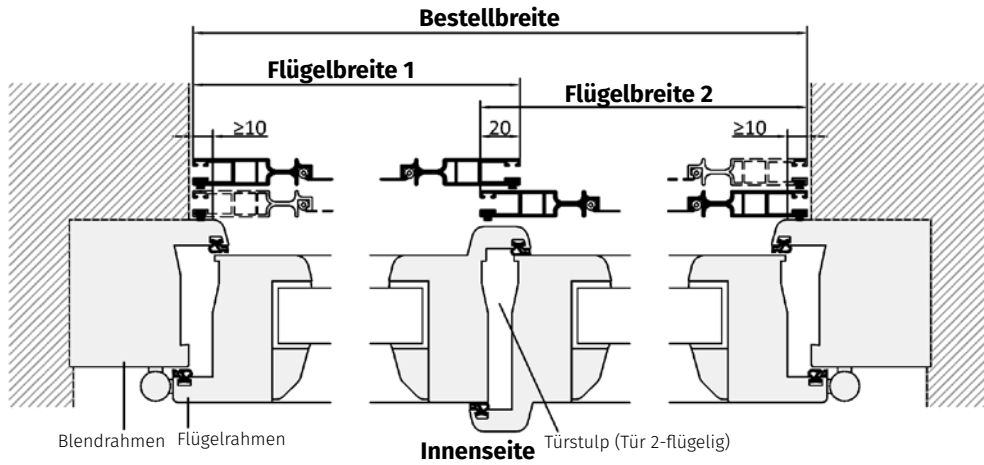

Einbaubeispiele

parallel laufend

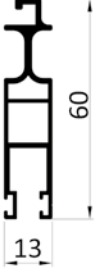
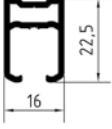

SCHIEBETÜR

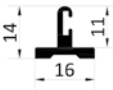
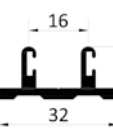
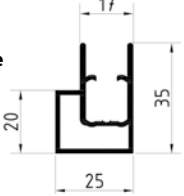
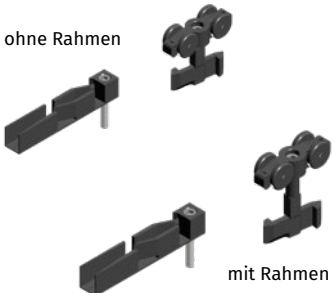
OBEN GELAGERT, 2-FLÜGELIG, GEGENEINANDER LAUFEND

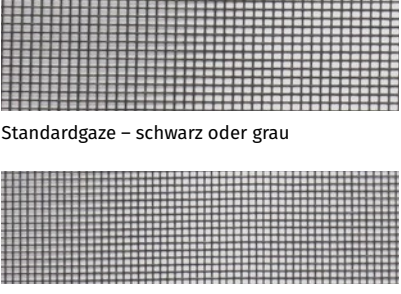
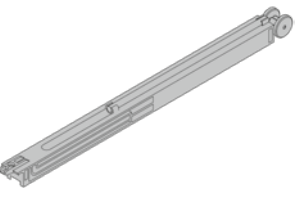
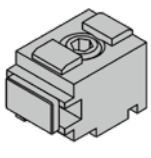
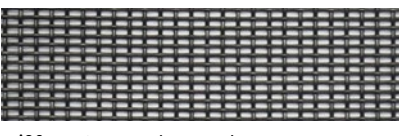
Flügelprofil (inkl. Griffleiste)	Rahmenprofil	
	<p>Standard</p> <p>U-Profil oben</p>  <p>Z-Profil unten</p> 	 <p>T-Bodenschiene unten</p>  <p>U-Bodenschiene unten</p>  <p>Rahmenprofil 3- oder 4-seitig</p>
<p>max. Elementgröße: Anlagenbreite = 6000 mm Anlagenhöhe = 2600 mm</p> <p>Flügelbreite: standardmäßig ein Viertel der Anlagenbreite, Sonderkonstruktionen möglich. Standard: Anlagenbreite = 4000 mm => Flügelbreite 1000 mm Sonderbau: Anlagenbreite = 4000 mm => Flügelbreite 1300 mm</p>		
Laufwagen + Quick-Slide	Farbe	Gazenauswahl
 <p>ohne Rahmen</p> <p>mit Rahmen</p> <p>Flügel werden mittels Laufwagen in der oberen Schiene geführt</p>	<p>Standardfarben</p>  <p>weiß braun SF</p> <p>RAL-Farben</p>  <p>ALUKON sonstige RAL-Farben RAL-Farbkollektion gegen Mehrpreis</p>	 <p>Standardgaze – schwarz oder grau</p> <p>Durchblickgaze</p>
Dämpfung (optional)	Anschlag (optional)	
<p>Soft Close</p>  <p>dämpft den Schlag des des Flügels gegen den Rahmen</p>	<p>Anschlag für Flügel</p>  <p>begrenzt den Verfahrweg des Flügels</p> <p>schwarz</p>	
		 <p>reißfeste Gaze – schwarz oder grau</p>

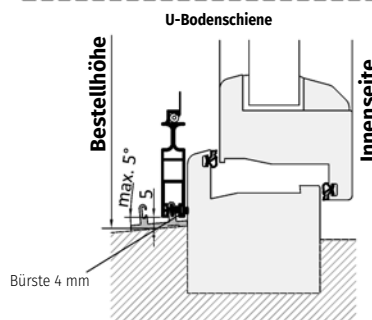
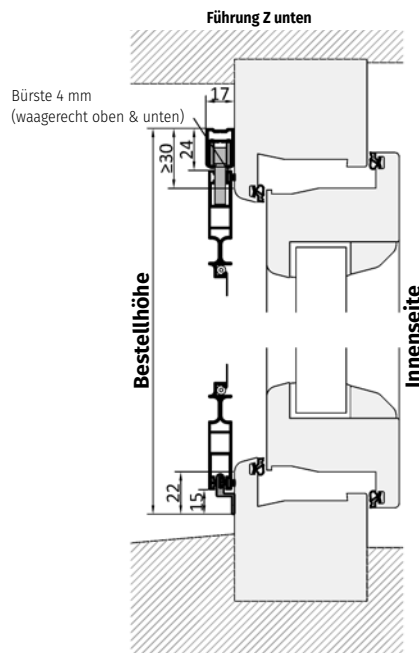
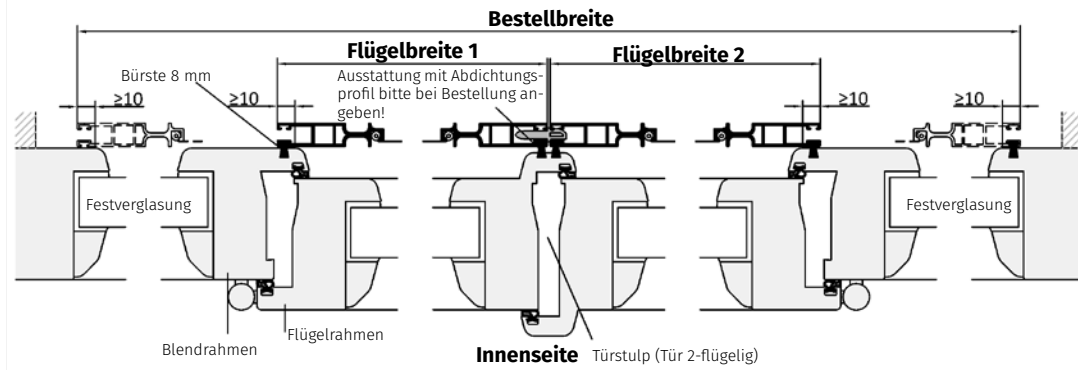

Einbaubeispiele

gegeneinander laufend

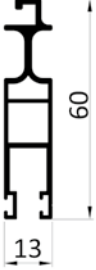
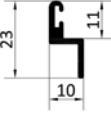
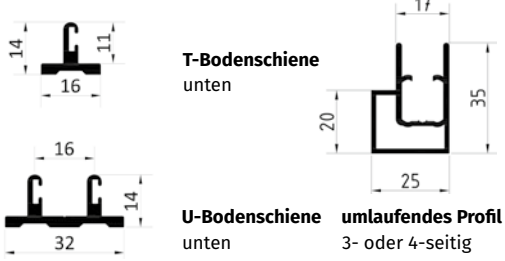
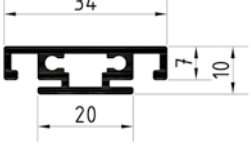

SCHIEBETÜR

UNTEN GELAGERT, 1-FLÜGELIG

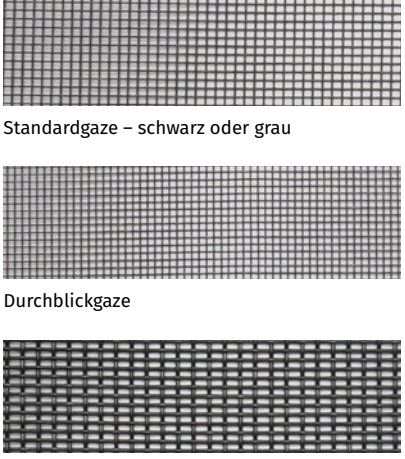
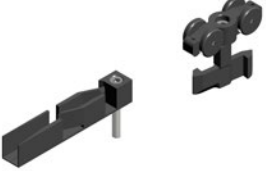
Flügelprofil (inkl. Griffleiste)	Rahmenprofil	
	<p>Standard</p>  <p>Z-Profil oben und unten passend zum Flügelprofil</p>	 <p>T-Bodenschiene unten</p> <p>U-Bodenschiene unten</p> <p>umlaufendes Profil 3- oder 4-seitig</p>
<p>max. Elementgröße: Anlagenbreite = 3600 mm Anlagenhöhe = 2600 mm</p> <p>Flügelbreite: standardmäßig die Hälfte der Anlagenbreite, Sonderkonstruktionen möglich. Standard: Anlagenbreite = 2000 mm => Flügelbreite 1000 mm Sonderbau: Anlagenbreite = 2000 mm => Flügelbreite 1300 mm Bei Flügelbreiten über 1500 mm wird zusätzlich mittig ein Stabilisierungsprofil montiert</p>		
Stabilisierungsprofil	Farbe	Gazenauswahl
 <p>ab 1500 mm notwendig</p>	<p>Standardfarben</p>  <p>weiß braun SF</p> <p>RAL-Farben</p>  <p>ALUKON sonstige RAL-Farben RAL-Farbkollektion gegen Mehrpreis</p>	 <p>Standardgaze – schwarz oder grau</p> <p>Durchblickgaze</p> <p>reißfeste Gaze – schwarz oder grau</p>
Laufwagen mit Feststeller		
		

Einbaubeispiele

mit Z-Z-Laufschiene

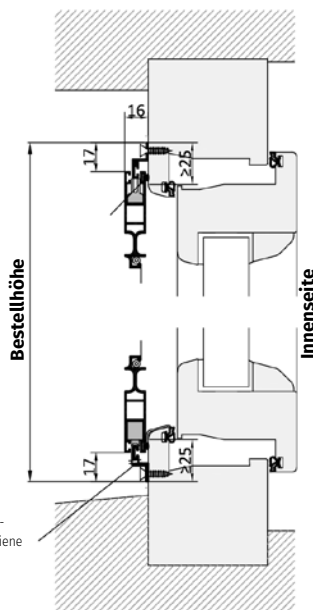
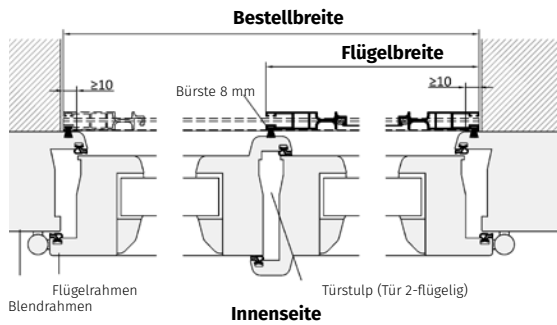

Bei Bedarf Entwässerungsöffnungen an der Laufschiene herstellen

mit umlaufenden Rahmenprofil

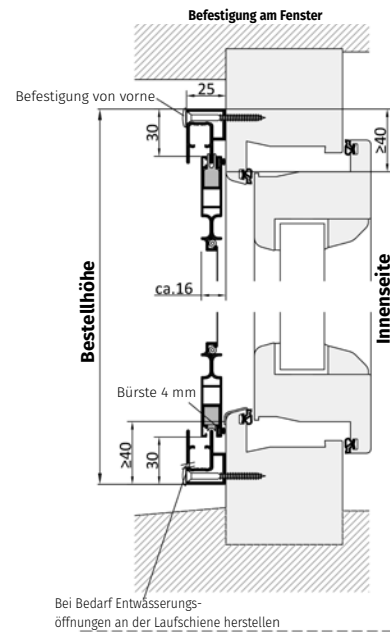
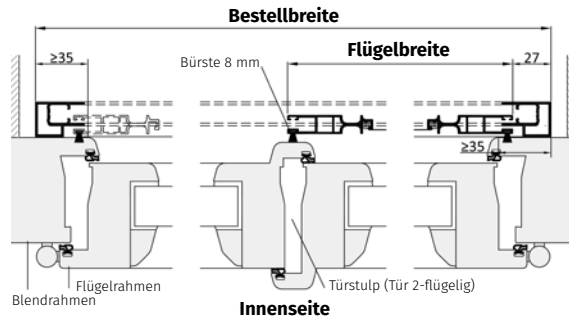



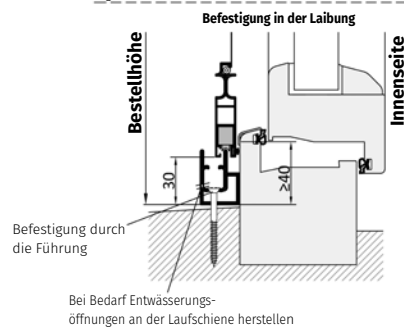





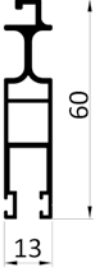
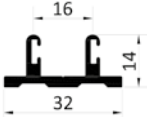

Bei Bedarf Entwässerungsöffnungen an der Laufschiene herstellen

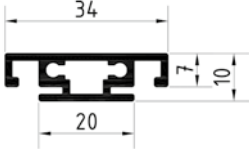

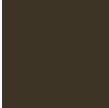
Bei Bedarf Entwässerungsöffnungen an der Laufschiene herstellen

SCHIEBETÜR

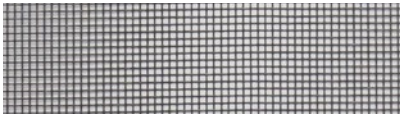
UNTEN GELAGERT, 2-FLÜGELIG, PARALLEL LAUFEND

Flügelprofil (inkl. Griffleiste)	Rahmenprofil	
	<p>standard</p> <p>U-Bodenschiene oben und/oder unten</p>	 <p>Umlaufendes Profil 3- oder 4-seitig</p> 
<p>max. Elementgröße: Anlagenbreite = 3600 mm Anlagenhöhe = 2600 mm</p> <p>Flügelbreite: standardmäßig die Hälfte der Anlagenbreite, Sonderkonstruktionen möglich. Standard: Anlagenbreite = 2000 mm => Flügelbreite 1000 mm Sonderbau: Anlagenbreite = 2000 mm => Flügelbreite 1300 mm Bei Flügelbreiten über 1500 mm wird zusätzlich mittig ein Stabilisierungsprofil montiert</p>		
Stabilisierungsprofil	Farbe	Gazenauswahl
 <p>ab 1500 mm notwendig</p>	<p>Standardfarben</p> <div style="display: flex; justify-content: space-around;"> <div style="text-align: center;">  weiß </div> <div style="text-align: center;">  braun SF </div> </div> <p>RAL-Farben</p> <div style="display: flex; justify-content: space-around;"> <div style="text-align: center;">  ALUKON RAL-Farbkollektion </div> <div style="text-align: center;">  sonstige RAL-Farben gegen Mehrpreis </div> </div>	 Standardgaze – schwarz oder grau  Durchblickgaze  reißfeste Gaze – schwarz oder grau

Einbaubeispiele

parallel laufend

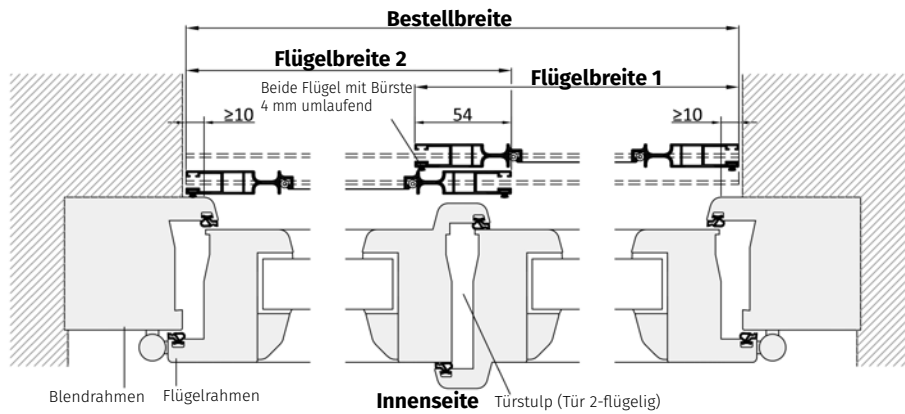

Brüstung gerade
U-Bodenschiene unten bis 10°
geneigt möglich. (Äußerer Flügel
sitzt dann entsprechend bis ca.
3 mm tiefer)

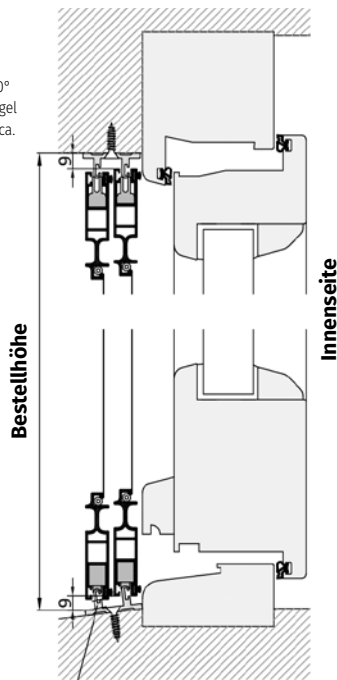



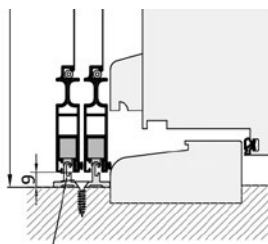



Bei Bedarf Entwässerungsöffnungen
an der Laufschiene herstellen

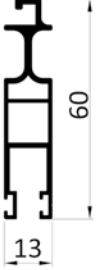
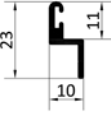
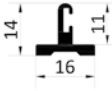
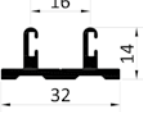
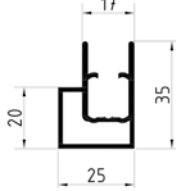
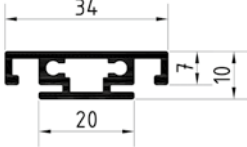
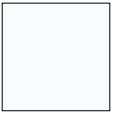

Entwässerung des Fensters/Tür muss gewährleistet bleiben.
Zusätzlich bei Bedarf Entwässerungsöffnungen an der Füh-
rungsschiene herstellen.

SCHIEBETÜR

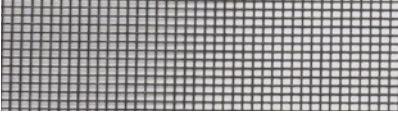
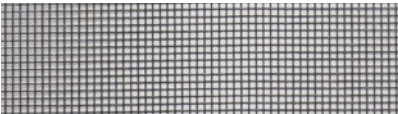
UNTEN GELAGERT, 2-FLÜGELIG, GEGENEINANDER LAUFEND

Flügelprofil (inkl. Griffleiste)	Rahmenprofil	
	<p>Standard</p> <div style="display: flex; justify-content: space-around; align-items: flex-end;"> <div style="text-align: center;">  <p>Z-Profil oben und/oder unten</p> </div> <div style="text-align: center;">  <p>T-Bodenschiene unten</p> </div> <div style="text-align: center;">  <p>U-Bodenschiene oben und/oder unten</p> </div> <div style="text-align: center;">  <p>Umlaufendes Profil 3- oder 4-seitig</p> </div> </div>	
<p>max. Elementgröße: Anlagenbreite = 6000 mm Anlagenhöhe = 2600 mm</p> <p>Flügelbreite: standardmäßig ein Viertel der Anlagenbreite, Sonderkonstruktionen möglich. Standard: Anlagenbreite = 4000 mm => Flügelbreite 1000 mm Sonderbau: Anlagenbreite = 4000 mm => Flügelbreite 1300 mm</p>		
Stabilisierungsprofil	Farbe	Gazenauswahl
 <p>ab 1500 mm notwendig</p>	<p>Standardfarben</p> <div style="display: flex; justify-content: space-around;"> <div style="text-align: center;">  <p>weiß</p> </div> <div style="text-align: center;">  <p>braun SF</p> </div> </div> <p>RAL-Farben</p> <div style="display: flex; justify-content: space-around;"> <div style="text-align: center;">  <p>ALUKON RAL-Farbkollektion</p> </div> <div style="text-align: center;">  <p>sonstige RAL-Farben gegen Mehrpreis</p> </div> </div>	 <p>Standardgaze – schwarz oder grau</p>  <p>Durchblickgaze</p>  <p>reifeste Gaze – schwarz oder grau</p>

Einbaubeispiele

gegeneinander laufend

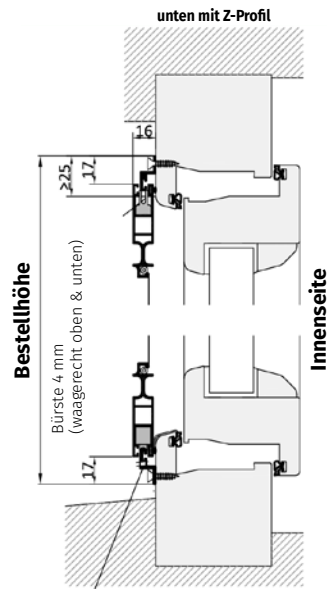
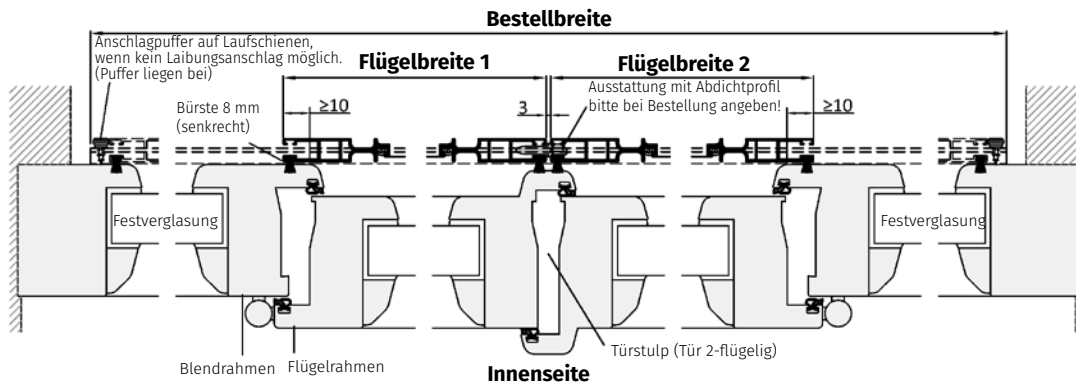

Bei Bedarf Entwässerungsöffnungen an der Laufschiene herstellen

unten mit U-Bodenschiene - U-Bodenschiene unten bis 10° geneigt möglich

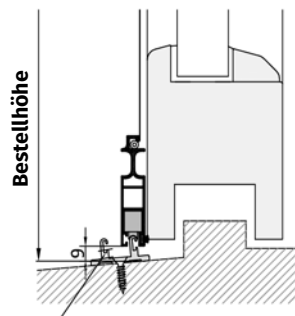

Bei Bedarf Entwässerungsöffnungen an der Laufschiene herstellen

SCHIEBETÜR

PLISSEETÜR, 1-FLÜGELIG

Profile

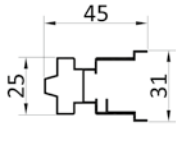

Griffprofil

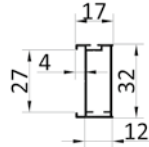

Rahmenprofil

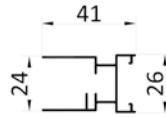

Kammerprofil groß

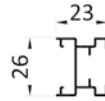

Kammerprofil klein



Führung oben

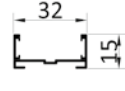

Führung unten

max. Elementgrößen: Elementbreite = 2100 mm Elementhöhe = 2400 mm
Flügelbreiten über 1500 mm nur mit schwarze Gaze.
Bei Elementbreiten über 1500 mm ist die Gaze 15 mm sichtbar

Farbe

Standardfarben



weiß



braun SF

RAL-Farben



ALUKON

RAL-Farbkollektion



sonstige RAL-Farben
gegen Mehrpreis

Insektengaze

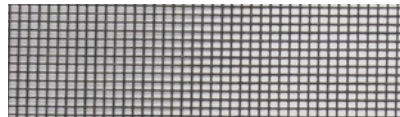

Standardgaze – schwarz oder grau

integriertes Magnetband (optional)

im Griffprofil integriertes Magnetband – zum besseren Schließen und Abdichten der Tür

Einbaubeispiele

Plisseetür, 1-flügelig

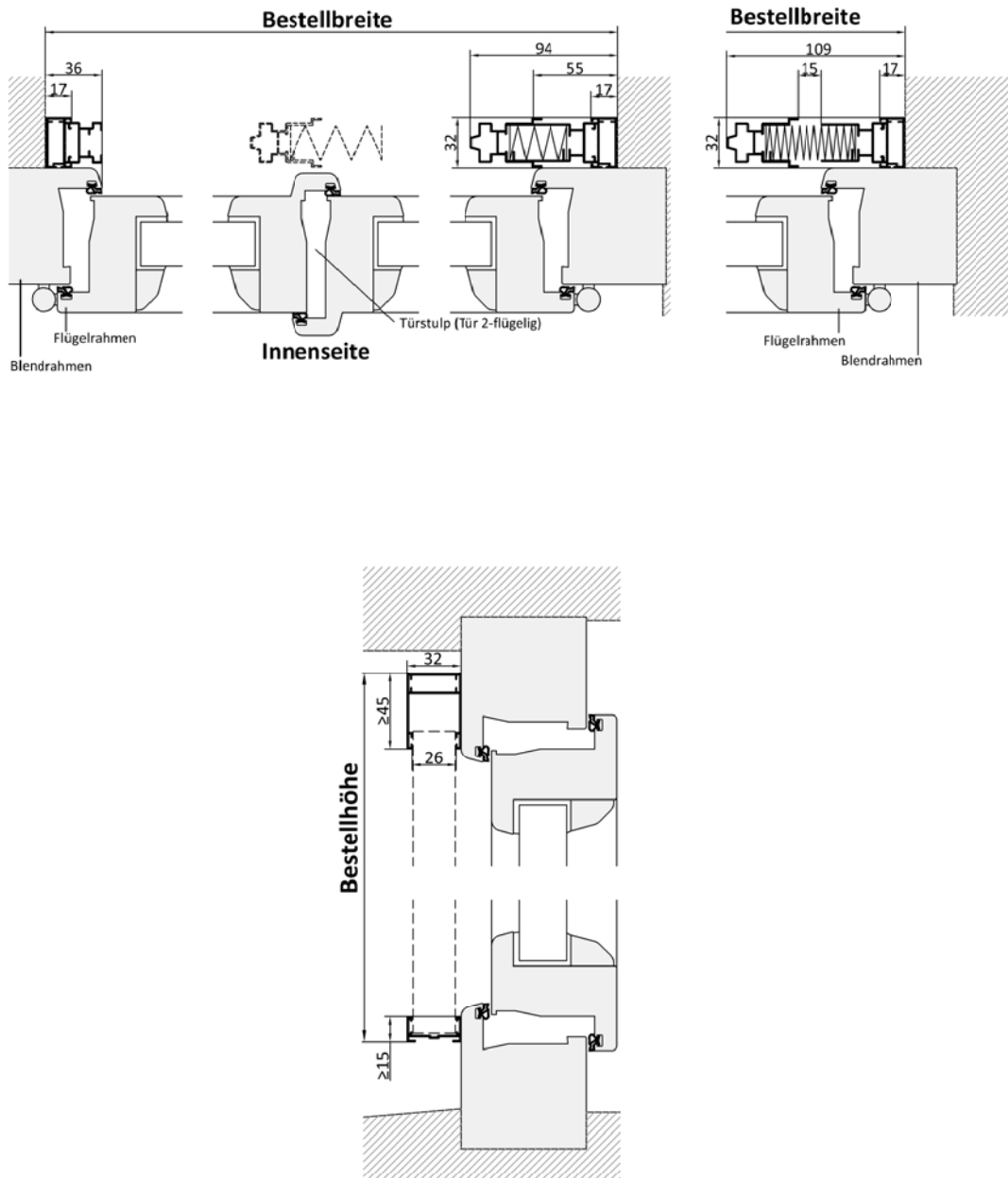

SCHIEBETÜR

PLISSEETÜR, 2-FLÜGELIG

Profile

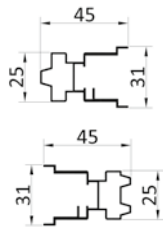

Griffprofil und Gegenstück

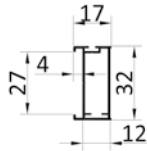

Rahmenprofil

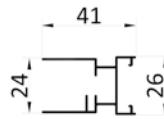

Kammerprofil groß

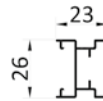

Kammerprofil klein



Führung oben

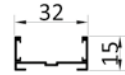

Führung unten

max. Elementgrößen: Elementbreite = 3600 mm Elementhöhe = 2400 mm
Flügelbreiten über 1500 mm nur mit schwarze Gaze.
Bei Flügelbreiten über 1500 mm ist die Gaze 15 mm sichtbar

Farbe

Standardfarben



weiß



braun SF

RAL-Farben



ALUKON
RAL-Farbkollektion



sonstige RAL-Farben
gegen Mehrpreis

Insektengaze

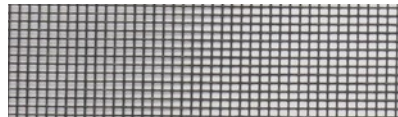

Standardgaze – schwarz oder grau

integriertes Magnetband (optional)

im Griffprofil integriertes Magnetband – zum besseren Schließen und Abdichten der Tür

Einbaubeispiele

Plisseetür, 2-flügelig

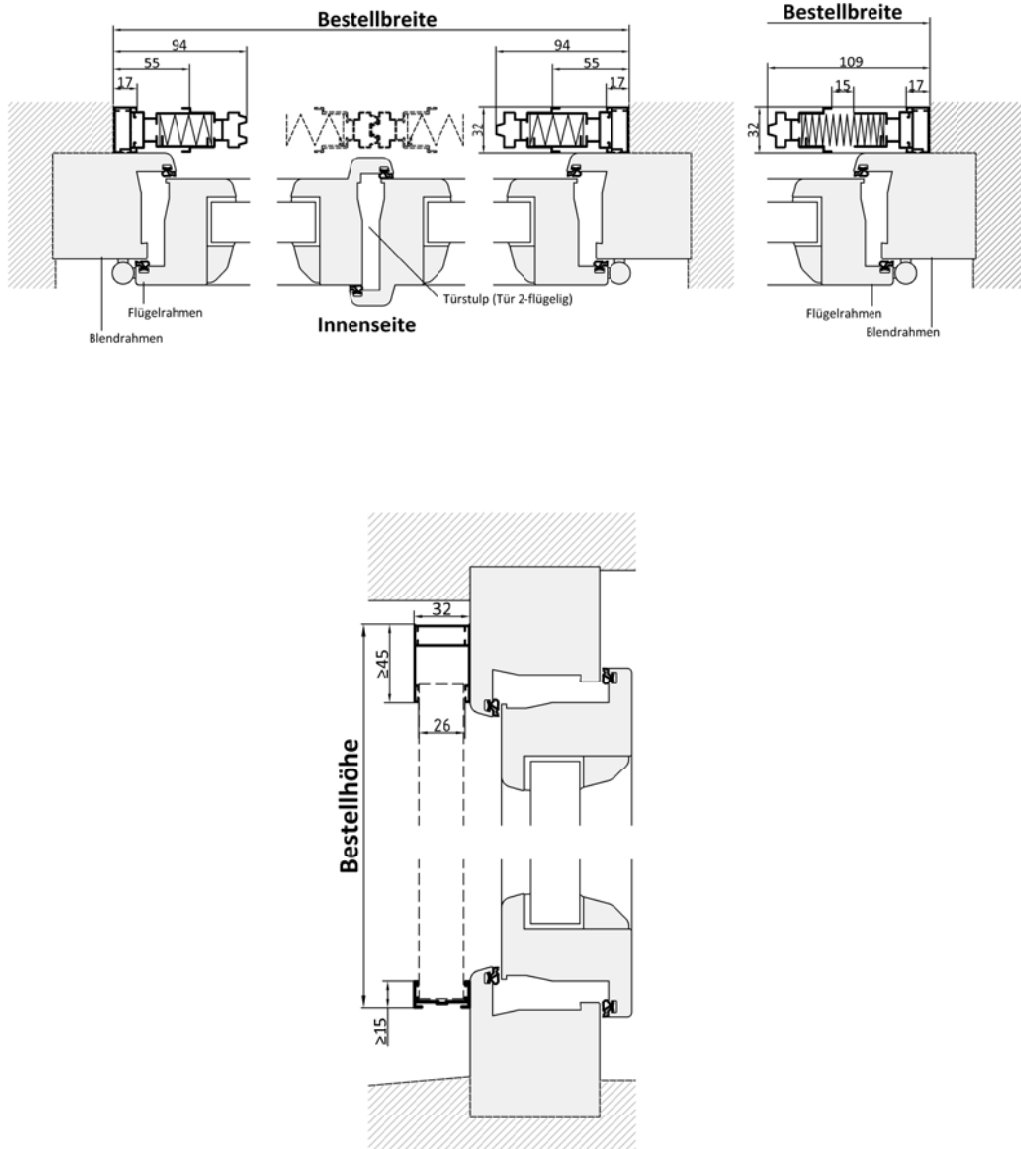

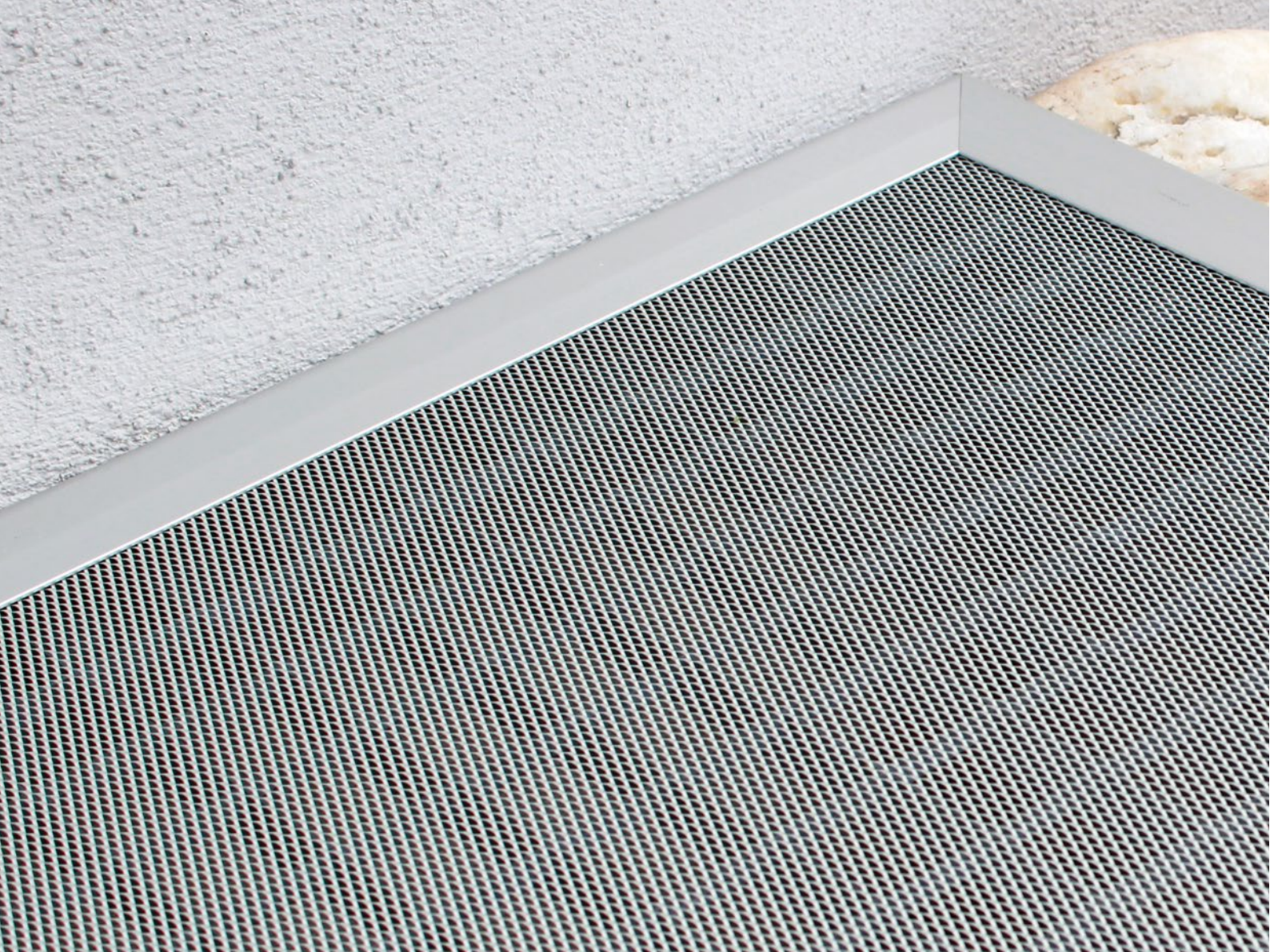

LICHTSCHACHTABDECKUNG

SCHUTZ DER KELLERSCHÄCHTE VOR LAUB UND UNGEZIEFER

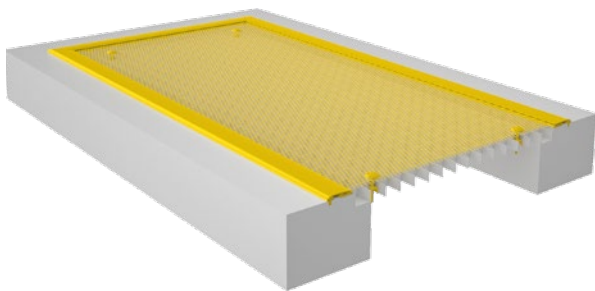



ALLGEMEINES

SPANNRAHMEN

INSEKTENSCHUTZROLLO



RAHMEN- UND PENDELTÜR

SCHIEBETÜR

LICHTSCHACHTABDECKUNG

LICHTSCHACHTABDECKUNG

LICHTSCHACHTABDECKUNG LA

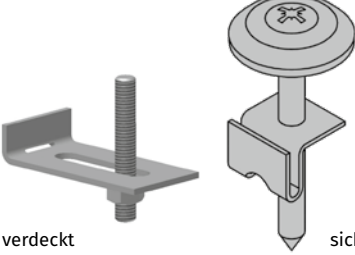
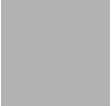
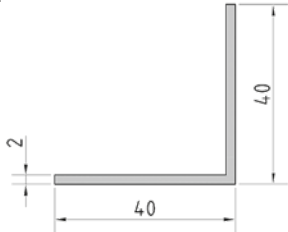
Profil	Streckmetall	Befestigung
 <p>stranggepresstes Aluminiumprofil mit 8 mm Bürste umlaufend, Abdichtung zum Bauwerk mit Winkelbürste</p>	 <p>silber eloxiert</p>	 <p>verdeckt sichtbar</p>
max. Elementgrößen: Breite 2000 mm Höhe 1000 mm		
Profilfarbe	Zusatzausstattung	
 <p>silber elox.</p>	<p>Alu-Winkel 40 x 40 x 2 bei Befestigung einer horizontalen und vertikalen LSA notwendig (siehe unteres Bild)</p> 	
Die Lichtschachtabdeckung muss auf ein vorhandenes Gitterrost montiert werden und ist nicht für begeh-/befahrbare Lichtschächte geeignet.		

Einbaubeispiele

Lichtschachtabdeckung

sichtbare Befestigung

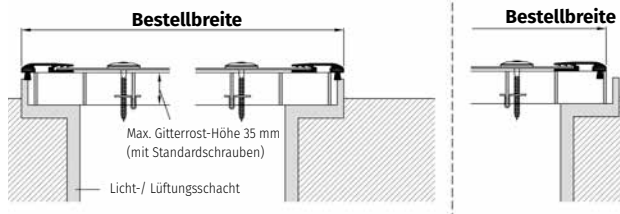

verdeckte Befestigung

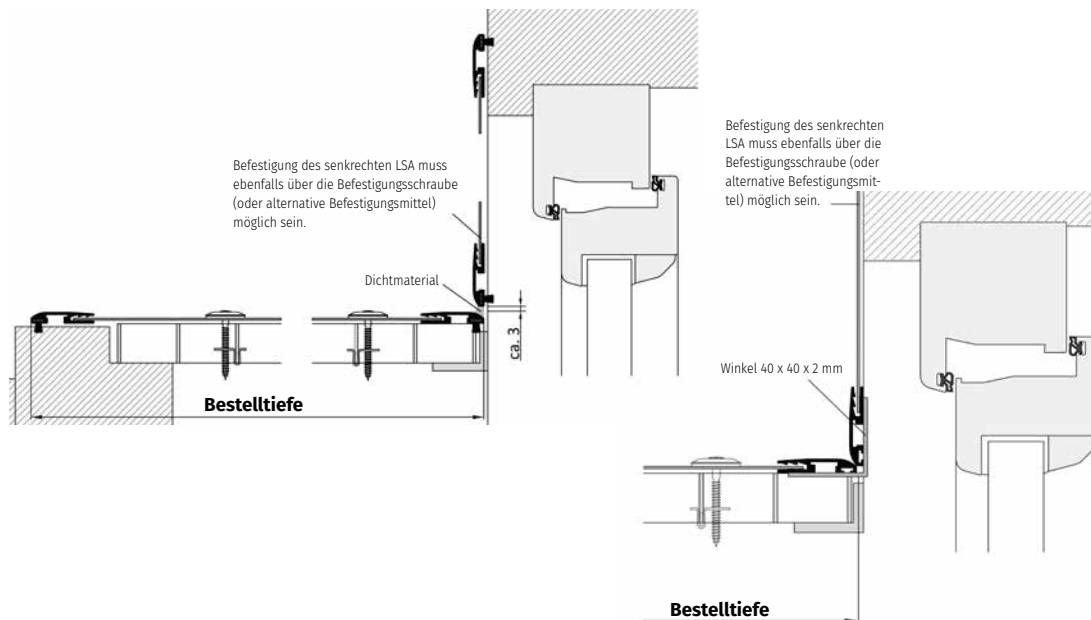
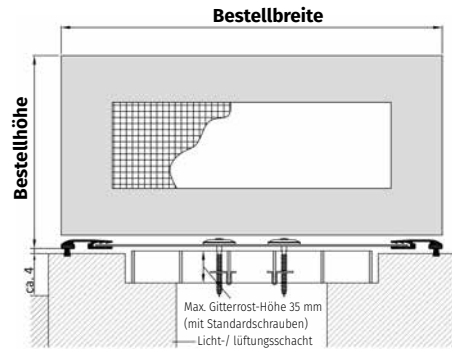

LICHTSCHACHTABDECKUNG

NOTIZEN

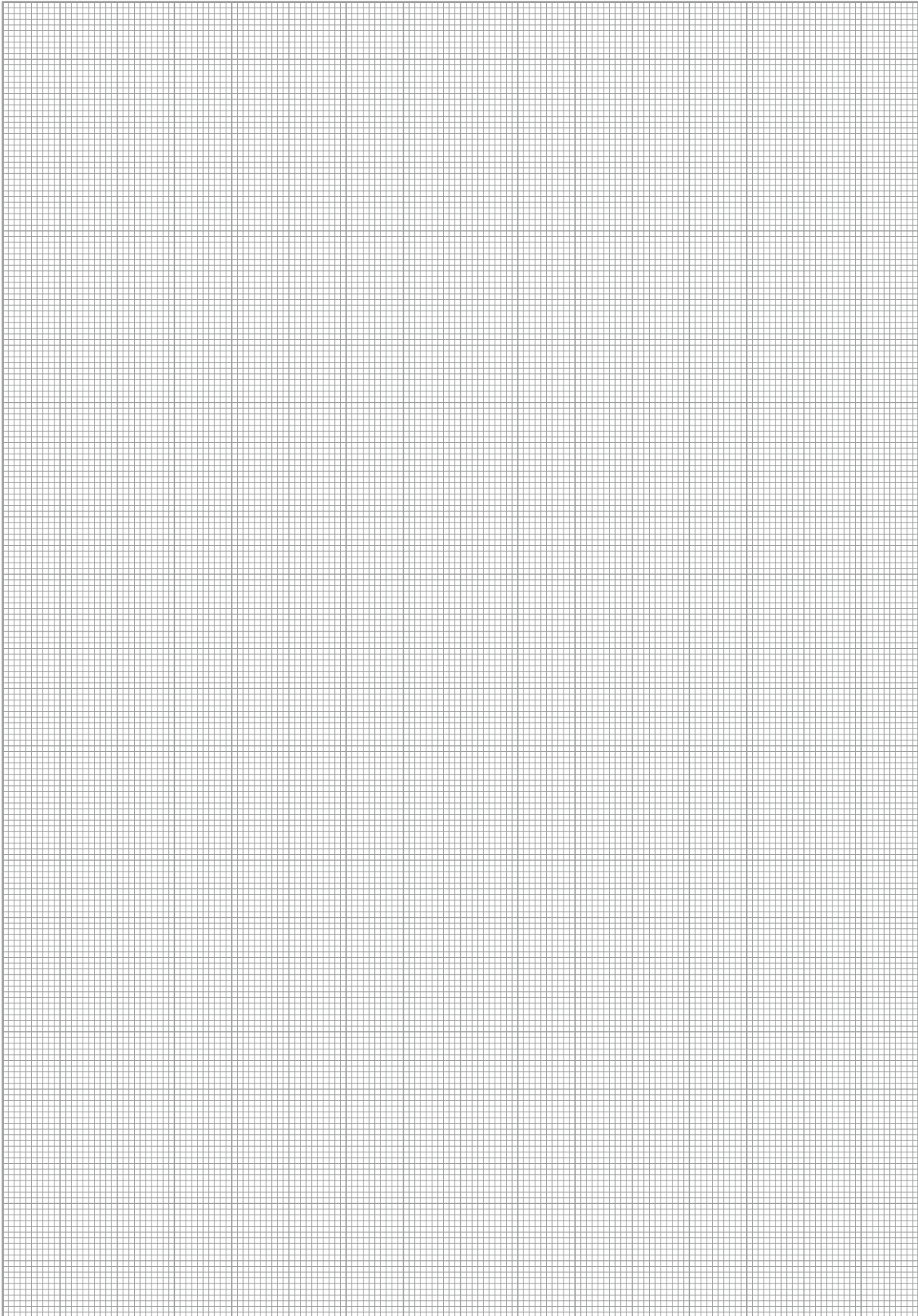

NOTIZEN

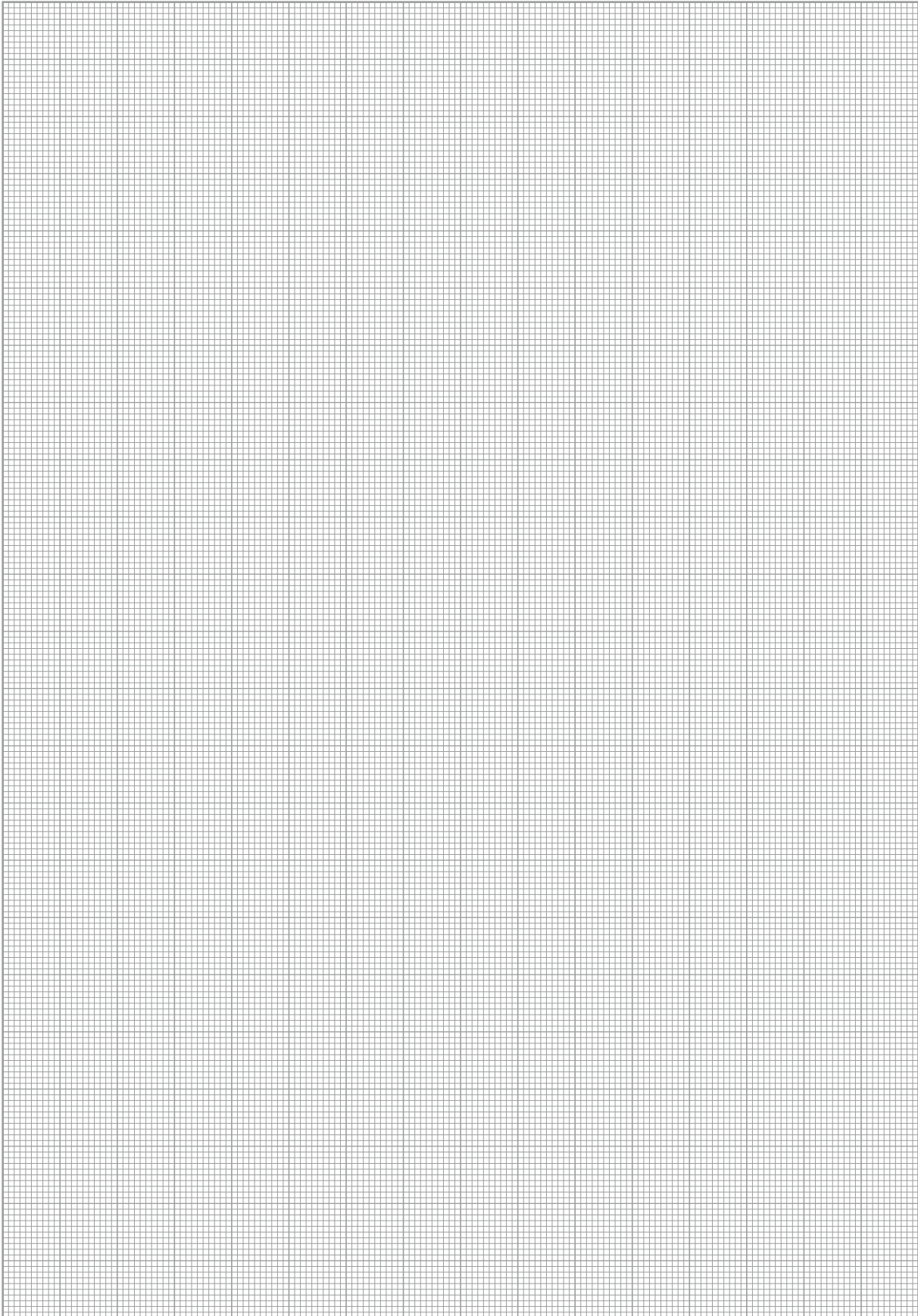

LICHTSCHACHTABDECKUNG

NOTIZEN

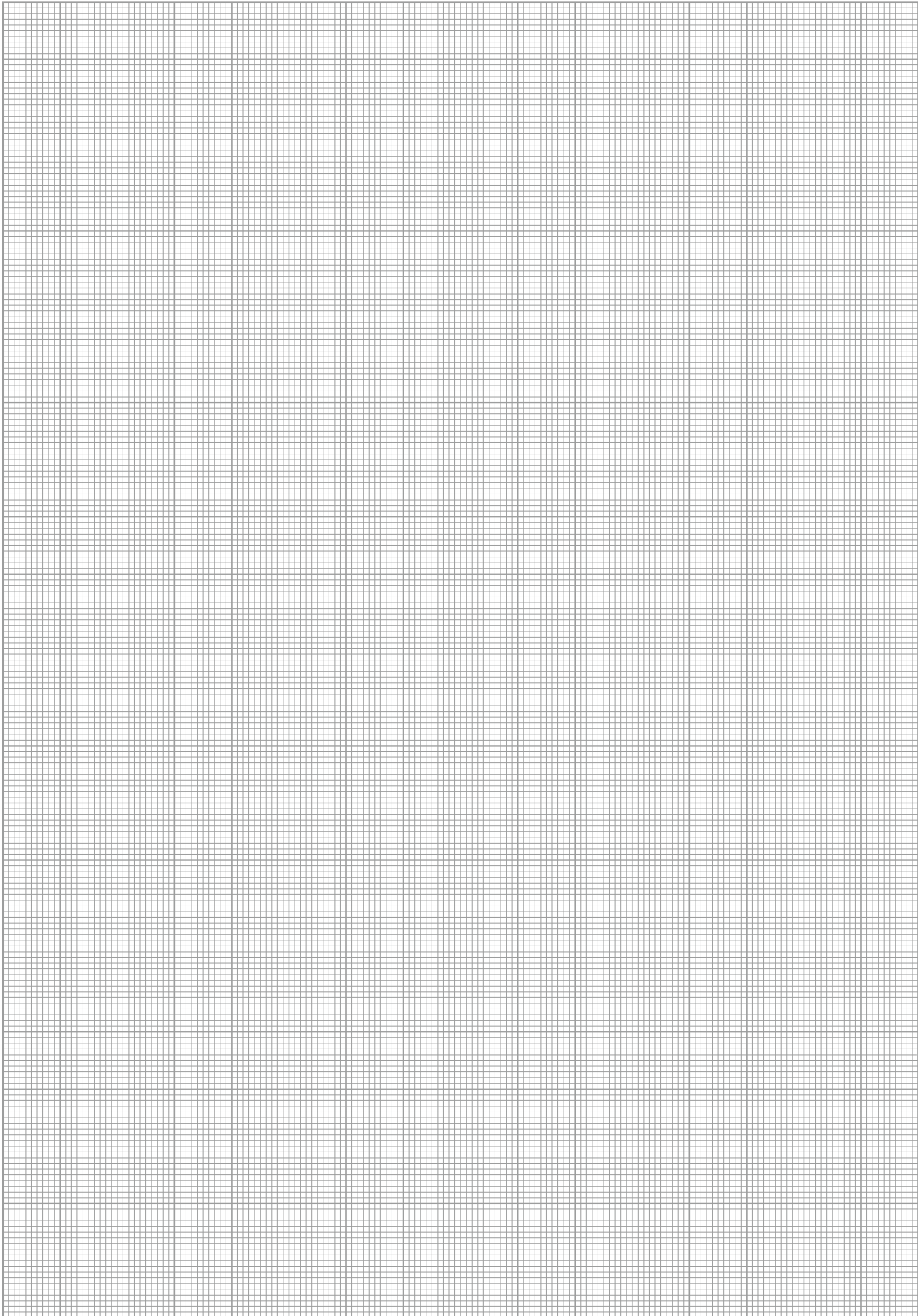

NOTIZEN

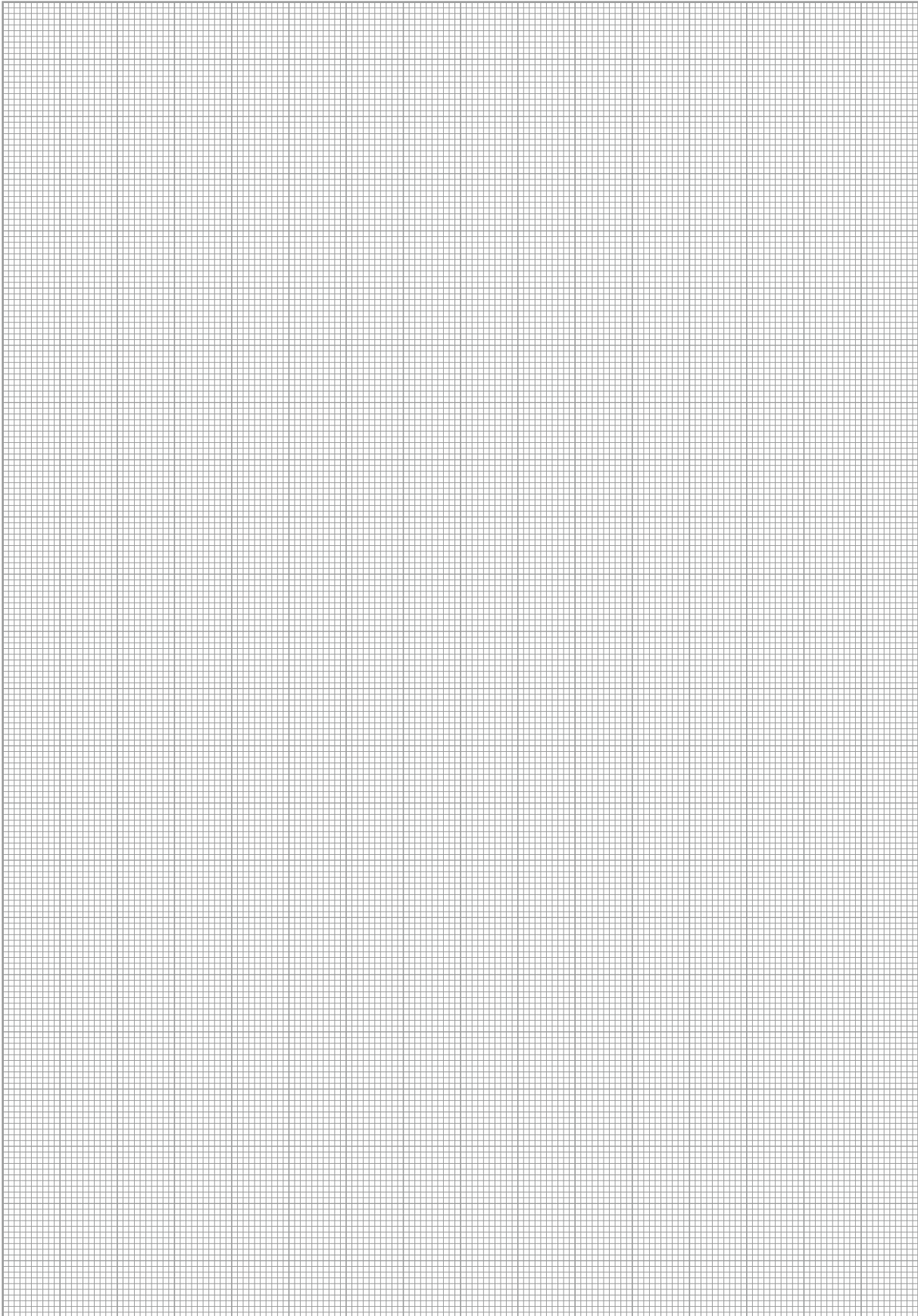

ALUKON
Sonnenschutz Rollläden Insektenschutz

ALUKON SONNENSCHUTZ, ROLLADEN UND INSEKTENSCHUTZ

QUALITÄTSPRODUKTE MADE IN GERMANY

ALUKON ist einer der führenden deutschen Hersteller von Rollläden, Sonnen- und Insektenschutzprodukten. Wir produzieren an zwei Standorten im oberfränkischen Konradsreuth und im schwäbischen Haigerloch.

Mit viel Engagement und hoher Innovationskraft werden ALUKON Produkte entwickelt und aus hochwertigen und langlebigen Materialien auf Maß gefertigt, egal ob für die Modernisierung oder den Neubau.

Finden Sie in unserer Produkt- und Farbvielfalt das Passende für Ihre Bedürfnisse und wählen Sie aus vielen Zusatzausstattungen. Wir bieten Ihnen individuelle Komplettlösungen aus einer Hand.

Mit den ALUKON Produkten können Sie Privatsphäre, Raumklima und Lichtstimmung im Raum individuell anpassen.

**Weitere Produkte und Neuheiten finden Sie auch auf
WWW.ALUKON.COM**

ALUKON KG KONRADREUTH | Münchberger Straße 31 | D-95176 Konradsreuth | **Telefon:** +49 9292 950-0 | **Mail:** info@alukon.com
HAIGERLOCH | Am Griesbaum 1 | D-72401 Haigerloch | **Telefon:** +49 7474 3914-0 | **Mail:** info.haigerloch@alukon.com

Beratung, Planung, Verkauf und Montage. Alles aus einer Hand.

ALUKON
Sonnenschutz Rollläden Insektenschutz

Satz & Gestaltung: ©ALUKON Marketing | Stand 04/2026 | Technische Änderungen vorbehalten. Art.-Nr. 897010120